

# 2025 Price List



EFFECTIVE JANUARY 1, 2025

**9to5**  
seating

# Table of Contents

## INFORMATION

2	About 9to5 Seating
3	Green Practice
4	Lifetime Warranty
6	General Information
7	Condition of Sale
8	Dimensions / Order Procedure / Lead Time
9	Packaging Codes / Upholstery Selection
10	Customer Material Program
11	Customer's Own Material / Leather Form
12	CAL TB 133 Fire Code
13	Two Tone Option
14	Custom Embroidery Submission Form

## SEATING PRODUCTS

16	New for 2025
18	Acclaim: 2780
20	Agent: 1425, 1660
24	Bella: 1310
32	Bristol: 2360, 2380
36	Cavo: 1910, 1912
40	Clary: 1510
42	Core: 2260
44	Cortina: 2900, 2910
48	Cydia: 3300, 3310
52	Dash: 1130
58	Diddy: 2450
60	Ellie: 9360, 9380
64	HÅG Capisco: 8105, 8106, 8107, 8126
66	HÅG Capisco Puls: 8001, 8002, 8010, 8020
68	HÅG Celi: 9100, 9140, 9160
70	HÅG Tion: 2100, 2140, 2160, 2200, 2240
72	Jax: 9201, 9204, 9206
78	Kelley: 1060
80	Kip: 1080
82	Koble: 9300, 9301, 9303, 9310, 9311, 9312, 9320, 9321, 9322, 9323, Typicals
88	Lilly: 9101, 9104, 9107, 9165
96	Link: 1410
98	Logic: 1725, 1760, 1780
106	Luna: 3460, 3461
110	Mila: 3760
112	Neo: 3160
114	Neo Lite: 3150
116	Omnia: 3860
118	Shuttle: 1210, 1250
124	Sol: 3680
126	Sophie: 8103, 8104, 8111, 8112, 8119, 8122, 8123
132	Sophie Tables: 8170, 8190, 8191
134	Strata: 1560
136	Strata Lite: 1545
140	Theory: 2170
144	Tori: 3560, 3580
148	Vault: 1460
150	Vox: 1090, 1094
160	Zoom: 1115
164	@Nce: 146, 205, 216, 217, 245, 305, 306, 750, 751

## ACCESSORIES

166	Arm Guide
170	Caster Guide
172	Control Selection Guide
176	Controls by Series
178	Parts Pricing
180	Product Options
182	Glide Guide
184	BIFMA Ultimate Test For Fit (UTFF), Care and Maintenance Instructions

# About 9to5 Seating

## Sit Down and Get Comfortable

Sit down and get comfortable. While sitting comes naturally, there's much more to the "get comfortable" part of this saying. It might take a simple height adjustment or a slide of the seat pan, but if the price of the chair does not align with your budget, it'll never be the right fit for you. Our team of industrial designers, engineers, and manufacturing automation specialists is constantly improving the product and discovering efficiencies in processes, resulting in greater value and shorter lead times. From task to lounge, we are designing and delivering chairs that are as gorgeous as they are functional, yet most find the quality most attractive. When comparing seating, fit and finish is often a pretty good indicator of price, but with us that's not the case. Our chairs are often perceived to be much more expensive than they are. Innovation, along with unmatched manufacturing prowess, is why other brands only talk about quality while we're able to back it up with one of the best warranties in the industry. Not only will you be comfortable specifying 9to5 Seating, you'll be able to relax, knowing the customer will be sitting pretty for years to come.

## Designed to Be Accessible

At 9to5 Seating, we place a strong emphasis on design and accessibility. Our efforts are laser-focused on one thing: improving efficiencies and the performance of seating. Our industrial design thinking, engineering forte, manufacturing automation, vertical integration, and sourcing savvy enable us to deliver quality, beautiful seating products that won't break the budget. Our chairs are built to be accessible, and that's just one of the reasons for our continued growth. Pair that with our award-winning designs and overall high quality, and it becomes easy to see why we're a favorite choice among both designers and facility managers.

## Customers, Please Take a Seat

Customers are at the heart of everything we do. Whether it's the occupants of the space, facility managers, interior designers, or furniture dealers, our passion is the relentless effort to please. In addition to great service, we have specialists in the field and at our headquarters, we invest in advanced technologies throughout our operations, which enables clients to configure products, order, track, and service with the utmost accuracy and shorter lead times. From the first meeting and throughout your relationship with 9to5 Seating, you can truly sit back and relax.

## Ahead of the Curve

At 9to5 Seating, we know that the pace of change is always accelerating. Our culture is one of innovation. It's in our atmosphere. Some say it's our forward-thinking California team, our constant exploration of what's next in design and technology, or the fact that we're a part of Flokk, the European leader in seating brands. We say it's all of those things and more. Bottom line: We do it so you can rely on 9to5 Seating to consistently deliver industry-leading innovations engineered to align with the needs of an ever-changing market.



### RESPONSIBLE

We are dedicated to eco-friendly and sustainable manufacturing practices.



### FORWARD THINKING

We believe in staying ahead of the curve when it comes to manufacturing and design.



### UNCOMPROMISING

We never settle. We insist on sourcing our own materials, utilizing cutting-edge technology, providing superior value, and satisfying our customers completely.



### ROCK SOLID

We have built top-quality products for more than 16 years - chairs that are built to last.



### CUSTOMIZATION

We allow our customers to customize their chairs to best suit their style and needs.

# Green Practice

## 9to5 Seating Commits to Thinking & Acting Green

9to5 Seating is committed to sustainable and environmentally responsible business practices. This global perspective is endorsed and executed throughout every aspect of our corporate culture, and within our warehousing, manufacturing and office facilities. We are proud to demonstrate our commitment by offering GREENGUARD GOLD Certified products, participating in the U.S. Environmental Protection Agency's WasteWise Program, achieving LEED® NC Gold Certification for our corporate headquarters facility and achieving BIFMA's LEVEL sustainability certification program for furniture.

## Environmental Commitment in Action

9to5 Seating's corporate headquarters uses a rooftop photovoltaic panel system to generate electricity for the facility. To view how much power we are generating in real time, visit our sustainability section at [9to5seating.com/sustainability/](https://9to5seating.com/sustainability/).

### Over 30 years, the system will offset:

- 6,102,370 lbs. of CO2 | a leading cause of global climate change
- 4,192 lbs. of NOx | a leading cause of smog
- 1,048 lbs. of SO2 | a leading cause of acid rain
- 1,215 lbs. of particulates | a leading cause of asthma

6,102,370 lbs. of CO2 is equivalent to the amount absorbed by 13 acres of trees over their lifetime

## LEVEL, GREENGUARD GOLD and LEED® Certified

9to5 Seating is committed to sustainable and environmentally responsible business practices. This global perspective is endorsed and executed throughout every aspect of our corporate culture, and within our warehousing, manufacturing and office facilities. 9to5 Seating chairs are BIFMA LEVEL 2 certified. HÅG chairs including Capisco, Capisco Puls, SoFi, Tion and Celi along with Ellie are BIFMA LEVEL 3 certified.

Developed by the Business and Institutional Furniture Manufacturer's Association (BIFMA), LEVEL is a voluntary certification program in which third-party auditors measure a product and its producer against the ANSI/BIFMA e3 Furniture Sustainability Standard. The LEVEL program was created to provide the most comprehensive, unbiased and transparent means of evaluating and communicating the environmental and social impacts of commercial furniture products. The LEVEL mark demonstrates that the product, the manufacturing facility, and the company responsible for the product brand, have all met the requirements for certification. Visit [www.levelcertified.org](http://www.levelcertified.org) for more information.

Our entire product line earned GREENGUARD GOLD Indoor Air Quality Certification issued by the GREENGUARD Environmental Institute. The program assures that products designed for use in office environments and other indoor spaces meet strict chemical emissions limits.

9to5 Seating products contribute to healthier interior environments. Our products are manufactured using plastic, nylon, steel, aluminum and polypropylene components that are 100% recyclable; we offer fabrics made from 100% recycled content; and we also use suppliers that share an Earth-friendly philosophy. We're proud that our products are certified below chemical emissions limits for TVOC, formaldehyde, total aldehydes, individual VOCs, and 4-phenylcyclohexene. Environmental Data Sheets for all 9to5 Seating products can be found at our web site [9to5seating.com/sustainability/](https://9to5seating.com/sustainability/). For more information about GREENGUARD programs, visit [www.GREENGUARD.org](http://www.GREENGUARD.org).

At its core, a green building is a better-performing building. It uses fewer resources and offers a better place to work through improved energy and water efficiency, better air quality, and access to natural daylight. We have been awarded the LEED® NC Gold Certification for our newly constructed corporate headquarters and manufacturing facility. Visit <https://9to5seating.com/sustainability/> to learn more about our commitment to sustainability.

# Lifetime Warranty

9to5 Seating products are manufactured with meticulous attention to detail to achieve a level of quality that is free from defects in material and workmanship. In an effort to stand behind this philosophy, 9to5 Seating warrants to the original purchaser of the product and from the original date of sale, the following:

For all series except @NCE, Logic Plus, Koble, Sophie, and chairs that include the Heavy Duty (HD) option in the Logic, Luna, Strata, Theory and Tori series, Lifetime Warranty to the original end user; the company will repair or replace, at its option, factory-defective structural and mechanical parts with comparable product, without charge. This warranty is for single-shift, standard commercial usage, defined as a standard eight-hour work day, five days a week. Weight limitations vary by product. For Sophie, Sophie tables and Koble series: 9to5 Seating warrants Sophie, Sophie Tables and Koble for a period of twelve (12) years of multi-shift use to the original purchaser. The company will repair or replace at its option factory defective structural and mechanical parts with comparable product, without charge.

Upholstery fabric, mesh and foam are warranted against wear through and deterioration during normal usage for a period of five (5) years. However, the company does not warrant leather against routine scratching and scuffing, as all leather is subject to minor blemishes during use. COM and COL are not warranted. Due to natural variations in material, furniture containing leather is sold subject to normal variations and/or irregularities of color, texture, and grain.

For the @NCE Series:

9to5 Seating warrants the @NCE series of chairs for a period of five (5) years of single-shift use to the original purchaser; the company will repair or replace, at its option, factory-defective structural and mechanical parts with comparable product, without charge. This warranty is for single-shift, standard commercial usage, defined as a standard eight-hour work day, five days a week. Weight limitations vary by product.

For Logic Plus Large Occupant Series:

9to5 Seating warrants the Logic Plus Large Occupant chairs for a period of ten (10) years of single-shift use to the original purchaser; the company will repair or replace, at its option, factory-defective structural and mechanical parts with comparable product, without charge. This warranty is for single-shift applications with persons weighing less than 500 lbs.

For the chairs that include the Heavy Duty (HD) option in the Logic, Luna, Strata, Theory and Tori Series:

9to5 Seating warrants the aforementioned chairs for a period of ten (10) years of multi-shift use to the original purchaser; the company will repair or replace at its option factory defective structural and mechanical parts with comparable product, without charge. This warranty is for multi-shift applications with persons weighing less than 350 lbs.

Only upholstery fabrics with an abrasion resistance performance rating of 150,000 double rubs or more are warranted against wear-through and foam deterioration for a period of three (3) years of multiple-shift use.

## Claim Process

Should parts fail for any model during normal use within the applicable warranty period, please fill out a Warranty Request Form on our website here: <https://9to5seating.com/warranty-request/>. Provide 9to5 Seating with a description of the failure and proof of purchase (Sales Order number located on the bottom of the chair). If requested by the company, the original purchaser must return the part or product with freight or other shipping charges prepaid, together with a copy of original sales receipt. Please do not send parts without prior authorization.

Send parts to:

9to5 Seating – Warranty Department  
3211 Jack Northrop Avenue  
Hawthorne, CA 90250

9to5 Seating will inspect the part in question, and repair or replace with a comparable product, at its option, any defective part at no charge to the original purchaser and return defective item thereafter. This warranty does not apply to product or parts of the product that have been subjected to misuse or abuse, accident, alteration, unauthorized repair, or damage in transit. You agree to indemnify and hold harmless 9to5 Seating, its officers, directors, shareholders, employees, and agents from any actions, claims, demands, damages, liabilities, costs, and strict liability in tort or contract, or any other legal theory arising out of the misuse or abuse, alteration, or damage in transit of the product. Under no circumstances will the company be liable for injuries or damages arising from the use of the product.

## Limitation of Liability

Under no circumstance, including but not limited to breach of contract, breach of warranty, or negligence, shall 9to5 Seating be liable for lost profits, loss of goodwill, stored data, general, special, consequential or exemplary damages, even if 9to5 Seating had notice of these damages or they were foreseeable. 9to5 Seating shall not be responsible for verifying dealers' or customers' description of needs, data, or fitness for a particular purpose of goods. 9to5 Seating's liability in all cases shall be limited to repair or replacement of the defective parts with a comparable product. Should a comparable replacement not be available, 9to5 Seating maximum liability will be limited to the original purchase price of the product. Damages resulting from misuse, abuse, alteration, negligence, or accidents are not covered under this warranty.

9to5 Seating makes no warranty that any of its products are suitable for any particular purpose and makes no other warranties, express or implied, other than those set out here. As codes and standards vary

# Lifetime Warranty

from one jurisdiction to another, references to compliance are solely for convenience and without any representation as to accuracy or suitability. Users must verify the suitability of such information or product for their specific application. In no event shall 9to5 Seating be liable in either tort or contract for any loss or direct, special, incidental, consequential, or exemplary damages.

EXCEPT AS OTHERWISE PROVIDED, 9to5 Seating MAKES NO OTHER WARRANTIES, EXPRESSED OR IMPLIED, INCLUDING BUT NOT LIMITED TO THE WARRANTIES OF MERCHANTABILITY AND FITNESS FOR A PARTICULAR PURPOSE.

## Labor Reimbursement

For products ordered on or after July 1, 2017, 9to5 Seating will only pay the pre-approved labor costs to repair or replace defective parts, up to 12 months from the date of shipment from 9to5 Seating, excluding the @NCE series. All payments for such preapproved labor costs will be in the form of a credit to an active company account. 9to5 Seating does not cover the disposal of defective parts or chairs. The disposal of defective parts or chairs are the responsibility of the customer.

## ANSI/BIFMA

The Business and Institutional Furniture Manufacturer's Association (BIFMA) has developed tests that have been approved by the American National Standards Institute (ANSI) for determining the strength and durability of seating in its everyday use. This statement does not serve as a warranty or guarantee, however, 9to5 Seating products found within this price list generally meet or exceed applicable BIFMA and ANSI standards.

## Warranty Exceptions

- Colorfastness or matching of colors, or textures occurring in leather, or other materials that naturally exhibit inherent color variations
- COM/COL textiles
- Damage of textiles from exposure to sunlight and UV rays
- Damage to textiles from the use of cleaners not specified for use in the fabric specifications
- Variation of texture and natural markings such as neck wrinkles, scratches, backbone marks and stretch marks in leather
- Dye transfers caused by external contaminants (including clothing and accessory dyes such as those used on denim jeans) may migrate to lighter colors. This phenomenon is increased by humidity and temperature and is irreversible.
- Color matching of textiles exactly to samples, swatches or prior purchases
- Minor variations of color in textiles
- Minor irregularities of color, surface, grain and texture
- Creasing and/or gathering of textiles during upholstery application process

- Product normal wear and tear, which is to be expected over the course of ownership, e.g., fabric, mesh and arm pads
- Damage caused by the carrier in-transit, which will be handled as separate terms and/or claims against the carrier.
- Damage can be defined as concealed or visible. Visible damage needs to be reported immediately. Concealed damage needs to be reported within seven (7) business days.
- Damage caused by delivery/installation contractors, which will be handled as claims against the designated company, e.g., knife cuts on the exterior surfaces of a chair resulting from opening packaging or removing plastic wraps
- Failures and damage which result from negligence, abuse, accident or misuse, e.g., arm pads repeatedly hitting a desk or table
- Damage caused by markings or staining; damage caused by sharp objects or imprinting from instruments
- Products exposed to extreme hot and cold temperatures or excessive dry environments
- Products that have been modified or altered and any attachments to the product
- Products or parts not used, maintained or installed in accordance with the Company's installation, maintenance and/or applicable guidelines
- Floor samples or display models
- Products purchased "as is" and/or secondhand
- Products sold by unauthorized dealers
- The warranty is limited to replacement or repair and does not cover cost of transportation, labor or installation.

9to5 Seating reserves the right to make changes in design and construction or discontinue products without prior notice. 9to5 Seating reserves the right to make changes to the lifetime warranty or price book.

Since textiles vary in weave, thickness and memory, some creasing and/or gathering may occur during the upholstery application process. Due to natural variations over which we have no control, all chairs are sold subject to minor irregularities of color, surface, grain, and texture. Textiles are sold subject to minor variations of color. Because leather is a natural product, variations of texture are common and should be expected. Leather will contain natural markings such as neck wrinkles, scratches, backbone marks and stretch marks. These distinctions give leather its unique characteristics and are considered to be part of the natural beauty of leather.

# General Information

## Hours

**Order Desk: Monday – Friday: 6:00 a.m. to 5:00 p.m. PST**

**Shipping & Receiving: 8:00 a.m. to 4:30 p.m. PST**

**Telephone: 888.925.SEAT (7328)**

[www.9to5Seating.com](http://www.9to5Seating.com)

**Visit our new Chair Designer, on our website, to build custom chairs to your project specs.**

## Condition of Sale

Possession of this price book does not necessarily constitute authority to purchase.

## Minimum Order Size\*

- Free freight for all orders of five or more 9to5 Seating and @NCE chairs
- \$20 (net) per chair for all orders of four 9to5 Seating and @NCE chairs or less

### Sophie Series Chairs\*

- \$120 (net) for Sophie orders of three units or less (excluding tables and accessories).

\*Minimum quantities for Sophie cannot be combined with other 9to5 Seating chair series

## Residential Delivery

- \$10 (net) per chair for 9to5 Seating and @NCE chairs. From the Sophie collection, only the single guest and bariatric models can be delivered to residences (residential delivery fee is in addition to the minimum order size charge if applicable).

## Payment

9to5 Seating accepts all major credit cards, company checks, cash, and terms payment for approved accounts. Credit card payments are subject to a 3% service charge. A \$35 fee will be charged for returned checks.

## Terms

Standard terms are net 30 days from date of invoice. Please respect these terms in order to protect your competitive pricing. Credit terms may be changed or canceled at 9to5 Seating's discretion.

1. All new accounts are required to remit a 50% deposit of the initial order's total dollar value prior to the order entry and the balance must be paid at the time of pick up or release to common carrier. A line of credit may be established upon acceptance of satisfactory references and the completion and signing of credit application.

2. The customer will be liable for any cost incurred in attempting collection of past due amounts, including attorney fees, whether or not a lawsuit is filed. Past due accounts are subject to a 2% per month (24% per annum) late charge, or maximum amount permitted under local law, for each thirty days, or part thereof that the outstanding balance remains unpaid beyond the thirtieth day after invoice date. Withholding of payments, because of carrier damages, shortages or other disputes is illegal and subject to charges.

3. Orders delayed due to credit hold will be rescheduled for production once the order has been credit released. A new lead time will be given at that time. Please contact Customer Care to coordinate details.

## Prices

All prices are suggested retail and are subject to change without notice. We make every effort to notify all customers of such changes. Prices in effect at the time of shipment will prevail. Please refer to our online price book for the latest changes including product drops and additions.

## Order Acknowledgment

Unless there is a credit issue or you are otherwise contacted, an order acknowledgment will be emailed to you once the order is approved by our Planning department. The order acknowledgment will confirm quantities, items ordered, and prices effective at the time of the order acceptance (prices may vary from the published list). Be sure to read these acknowledgments and contact us immediately if incorrect.

## Shipping

Complete and specific instructions for shipping should be given at the time an order is placed. Orders that do not have specific instructions will be routed by the best method of shipment in accordance with the judgment of our traffic department. Any changes to shipping instructions must be submitted to our office in writing. Standard shipments are made via common carrier unless otherwise requested by the customer. Special routing requests made by the customer or the consignee may result in additional charges. Standard deliveries are dock-to-dock and are scheduled to occur Monday through Friday between 8:00 a.m. to 4:30 p.m.

9to5 Seating reserves the right to charge the customer for non-standard customer delivery requirements that may include delivery appointments, drop shipments, inside deliveries, residential, limited access, or requests for trucks with lift gates. Additional charges may also be incurred for redeliveries or re-consignments if the initial delivery cannot be made for any reason. 9to5 Seating will not be held responsible for issues or costs to the customer arising from carrier transit delays or missed appointments. For information concerning these charges, please contact Sales Support.

## Change of Delivery Address Charges

- \$25 (net) charge for change of delivery address for small parcel (via Fed-x)
- For change of address requests for all other shipment methods, contact Customer Care

## Guaranteed Delivery and Delivery Appointment

Shipments are not guaranteed. Guaranteed service is available at an additional cost. Please contact Customer Care for more information. We will work to arrange a specific delivery time with the carrier. Service guarantees contracted with carrier are done solely at the request of the customer and 9to5 Seating in no way assumes responsibility financially or otherwise for any costs incurred by the customer as a result of a carrier's failure on a guaranteed shipment. In the event of a carrier's failure on a guaranteed shipment, the associated guaranteed service fee will be removed.

## Expedited Freight

Expedited service is available at an additional cost. Please contact Customer Care for more information

## Drop Shipments

9to5 Seating will not drop ship without prior approval; additional charges may apply. Please contact Customer Care for additional information.

# General Information

## Fee Schedule

LTL – ACCESSORIAL CHARGES – Standard deliveries are dock-to-dock during standard business hours.

### Courtesy Call Before Delivery (CCBD): \$0

- This is NOT a delivery appointment (not guaranteed a call will happen but will be requested)
- BOL Instructions = “For Carrier Convenience ONLY, call John Smith at XXX-XXX-XXXX”
- This is not applicable to FedEx parcel shipments

### Mandatory Call Before Delivery (MSBD): \$25

- BOL Instructions = “MUST CALL before delivery, John Smith at XXX-XXX-XXXX”
- Guaranteed Delivery: Contact shipping department for quote
- BOL Instructions: “GUARANTEED DELIVERY, MUST DELIVER ON XX/XX/XX, Must Call John Smith at XXX-XXX-XXXX”

### Liftgate for Delivery: \$100

- BOL Instructions = “Lift Gate Required for Delivery”
- Inside Delivery: Contact shipping department for quote
- Minimum of \$60, Based on weight and number of units, therefore every request needs to be quoted by shipping department

### Blanket wrap orders fee: \$450

### Limited Access Delivery: \$125

- Everything other than a standard dock-to-dock business location delivery, such as hospitals, schools, universities, construction sites, military bases, hotels, resorts, government buildings, casinos, amusement parks, golf courses, airports, etc.
- Limited access locations where a dock is difficult to access with a 53-ft. trailer

### Redelivery: \$100

- In the event that no one is available to receive a shipment and a redelivery is necessary

### Drop Shipments Direct to Site: \$150

#### (Includes Delivery Appointment)

- If within standard business hours and dock-to-dock; if there is a wait time to off load, additional charges will be incurred

### Product Design

9to5 Seating reserves the right to make alterations in design and construction or to discontinue products without prior notice.

### Change Orders

Orders that have been scheduled for production may not be changed. All changes on customer orders previously acknowledged must be requested in writing and subject to approval. In the event a revision is accepted, change fees may apply.

# Condition of Sale

## Will Call

Will Call orders will be scheduled and manufactured based on Customer requested completion dates. Customers will receive a notification once the Will Call order is ready to be picked up. Customers will have five (5) business days to pick up the order. If the order is not picked up within this time frame, 9to5 Seating will ship the order to an offsite storage facility and will invoice the Customer. The following storage fees will be invoiced to the Customer:

- 1- 50 chairs: \$25/day
- 51-100 chairs: \$50/day
- 101+ chairs: \$75/day

Please direct any questions about the new Will Call policy to your Customer Care Representative at sales@9to5seating.com or 888.925.3728.

## Freight Damage or Shortage

Before accepting a shipment from the carrier, check the boxes for visible damages. If a shortage or damage occurs during transit, it should be noted on the freight bill of lading at the time of delivery, and a claim filed within seven days from receipt of product. If concealed damage is discovered after delivery, request inspection from the delivering carrier IMMEDIATELY and save all packing materials until inspection is made. Contact Customer Care as soon as possible to report damage or shortage.

For all Will Call orders, make sure to inspect merchandise thoroughly. 9to5 Seating will not be liable for any damage or shortage to merchandise after it has been signed for at our dock. 9to5 Seating will not be liable for any installation costs that result from freight damage.

## Cancellations & Returns

Due to immediate production scheduling, orders that have entered any stage of production cannot be canceled. All 9to5 Seating chairs are made-to-order, custom designed chairs and are not “off the shelf”. Requests for cancellation are not accepted until confirmed by 9to5 Seating. Product may only be returned after receiving a Return Merchandise Authorization number from 9to5 Seating. Returns are subject to a restocking charge equivalent to 35% of the net order plus freight. Unauthorized returns will be refused.

## Replacement Parts

When ordering a replacement part submit a warranty request through our website by navigating to the warranty page and selecting the Warranty Request Form. As a helpful tip, have your 9to5 Seating Sales Order number available and please reference your instructions sheet to properly identify the correct part for your 9to5 Seating product.

Replacement parts are shipped within 48 hours from time of request. 9to5 Seating does not reimburse for labor and installation costs related to warranty replacements. Replacement parts needed to repair freight damage can be granted only if the request is received within five business days of receipt of the merchandise.

# Dimensions

**Outside Width (W)** - Distance measured at widest edges of chair.

**Outside Depth (D)** - With the outside back of chair against wall, the distance from the wall to the front edge of seat.

**Outside Height (H)** - Distance from floor to highest point of back.

**Seat Width (SW)** - Distance measured at narrowest point of seat's side edges.

**Seat Depth (SD)** - Distance measured using the BIFMA CMD (Chair Measuring Device) from the most prominent point of the lumbar to the front edge of the seat.

**Seat Height (SH)** - Distance measured using the BIFMA CMD (Chair Measuring Device) from the floor to the bottom of the device on the front edge of the seat. The CMD weighs 100 lbs.

**Back Width (BW)** - Distance measured at narrowest point of back's side edges.

**Back Height (BH)** - Distance measured from inside edge of rear seat to top edge of back.

**Inside Arm Width** - Distance between arms, typically measured from mid-point.

**Arm Height** - Measured from the floor to top edge of arm.

# Order Procedure

## To Place an Order

1. Fax your order to: **866.925.SEAT**
2. E-mail your order to: [sales@9to5seating.com](mailto:sales@9to5seating.com)

Specify complete model number, frame or plastic color, fabric pattern and color, quantity, ship-to address, payment method, and purchase order number. In the event that an error is made in production of the chair, the hard copy of the purchase order will be used as the resolution document.

## Order Acknowledgment

Unless there is a credit issue or you are otherwise contacted, an order acknowledgment will be sent once the order is released from our Purchasing department. It will be faxed or emailed to you to confirm quantities, items ordered, and prices effective at the time of the order acceptance (prices may vary from the published list). Be sure to read these acknowledgments and contact us immediately if incorrect.

## Shipment Notification

Upon shipment of an order a shipment notification will be faxed or emailed with carrier information.

# Lead Time

9to5 Seating intends to have all approved orders ready for shipment within the below lead times. However, there may be delays due to causes beyond our control. Orders received after noon PST will be considered as having been received the following day. Credit must be cleared before processing. 9to5 Seating is not responsible for late deliveries from freight carriers.

## LEAD TIMES

**1 Day ExpressShip includes the @NCE series.**

**5 Business Days ExpressShip** includes all series excluding Lilly, Jax, Ellie, Koble and Sophie and new products for the following fabric cards: 9to5 Seating Breeze, 9to5 Seating Signature, 9to5 Seating Vivid, Momentum Swift 2.0 and 9to5 Seating Highlands L3.

**Please specify "5 Day ExpressShip" on a separate purchase order** to ensure proper handling and delivery time. **DO NOT COMBINE** with any other purchase order. In the event that a purchase order is not marked, order will be scheduled per our standard lead time below.

**Standard 10 Day Lead Time** includes all series excluding Sophie and new products for the following textiles: 9to5 Seating's cards including Breeze 2.0, Nautilus, Signature, Highlands L3 and Vivid. Supplier cards including Momentum Swift 2.0 and Performance 4.0, Green Hides Sierra L4, Maharam M Series, Stinson Fresh Energy and Ultrafabrics Impress the Senses.

**Standard 15 Day Lead Time** includes all series, all fabrics for the Standard 10 Day Lead Time plus Green Hides L5 Lena and graded-in textiles.

**Contact Customer Care at (888) 925-7328 for lead times on large orders.**

# Packaging Codes

## How to Specify

9to5 Seating offers several packaging methods for most models. Please note not all packaging codes are available for each model. Reference the price book page for the model in question to view the packaging methods available. All available packaging methods and their corresponding prices can be found at the top of the price book page.

After determining the appropriate packaging method, please add the packaging code to the model nomenclature of the model as it appears on your purchase order. Example: 1725-M1-A4-101-AB.

## AB – Assembled in Bag for Will Call and Blanket Wrapped

The chair will be fully assembled and covered with a clear plastic bag for protection from dust. Chairs shipping via blanket wrap carrier will be produced with packing method “AB” as the chairs will be picked up at the dock fully assembled in the will call area.

## PAC – Partially Assembled in Carton

The chair will be produced and packed partially assembled typically with seat and back separated, and arms and controls pre-assembled in a shipping carton. Specially designed spacers are used to position all chairs in the carton and to prevent freight damage.

## BAC – Back Assembled in Carton

The chair will be fully assembled with exception of the base, gas lift and casters that are packed into a specially designed carton for this hardware. The chair may be removed, casters placed in the base, gas lift placed in the base and the remaining chair set on top of the cylinder. No tools are required.

## AC – Assembled in Carton

The chair will be fully assembled and placed in a carton. This applies primarily to guest chairs that must ship fully assembled to accommodate chair design. Some guest chairs ship with multiple chairs in one carton.

# Upholstery Selection

## Fabrics

Choose from thousands of different fabrics, comprised of varying price grades offered through 9to5 Seating’s fabric cards. If you still can’t find what you are looking for, you may choose from any of the textiles offered by one of our textile partners. There are thousands of patterns and colors to choose from. To make this easy for you, we have graded-in their entire product lines. Please refer to our website’s Materials section to access the graded-in fabrics PDF.

Please note that while we strive to accurately represent our fabric swatches online, variations in screen settings and lighting may cause colors to appear slightly different in person. We recommend referencing physical fabric samples or requesting fabric swatches before making your final decision.

## Leather

9to5 Seating offers three grades of leather. All L3 and L4 are upholstered with leather on the seating surface and vinyl on the back and side boxing. L5 is an all-leather cover. 9to5 also has a COL (customer’s own leather) program.

L3 is a glove-soft, top grain European hide, available in Black.

L4 is a glove-soft, top grain Italian cowhide leather.

L5 is a luxurious Italian full-grain, semi-aniline dye leather with a soft hand and smooth supple surface with even coloration throughout the entire hide.

## Fabric Orientation

In order to offer optimal customization with our upholstery, customers must indicate a railroad orientation on a purchase order. Fabric manufacturers suggest within the specifications if a fabric pattern is recommended for railroad orientation. Refer to the graded-in PDF on the 9to5 Seating website with fabrics with a railroad orientation.

Railroad or horizontal orientation requires more fabric than vertical orientation. When railroad orientation is requested, the fabric grade will be increased by one grade to compensate for any additional fabric. Please indicate railroad orientation if this is desired on a purchase order. The order will be handled as a special, and the railroad orientation will be executed. Please contact your Customer Care Representative if you have questions about railroad orientation.

# Customer Material Program

**COM = customer's own material**

**COL = customer's own leather**

## Ordering Instructions

Contact Customer Care for inquiries regarding COM/COL or follow the instructions below to assure the best results to produce your COM/COL order.

Complete 9to5 Seating COM/COL form (see opposite page or download from website) and send it to 9to5 Seating along with a fabric sample.

All COM/COL fabrics must be approved by 9to5 Seating and will not be scheduled for production until the entire yardage/square footage requirements have been received. Approval can be completed by 9to5 Seating in 72 hours. 9to5 Seating will not return any excess COM/COL material. After 60 days from when the order ships, any excess COM/COL material will be recycled.

For non-directional, plain, solid colors or non-patterned fabrics, please follow COM yardage requirements as specified under each individual model number in our price list. For fabrics which require special application or direction, please attach a sample of the COM fabric to our COM form.

Include all information and return to 9to5 Seating at address shown below. All COM textiles received at 9to5 Seating must be clearly marked with customer's name, purchase order number, 9to5 Seating sales order number (if available) and any special instructions for application of textile.

Send fabric to:

9to5 Seating  
 Attn.: COM Fabric Receiving  
 3211 Jack Northrop Ave.  
 Hawthorne, CA 90250

Upon receipt of COM textile, a production date will be given to the order and you will receive an acknowledgment by fax or e-mail.

## Notes

1. COM/COL EXCESS YARDAGE - 9to5 Seating is not responsible for yardage submitted to 9to5 Seating beyond the required amount. Excess COM/COL materials will be discarded at the discretion of 9to5 Seating unless otherwise instructed by the customer at the time of order placement. If a customer requires the COM/COL excess yardage returned, they must contact Sales Support before order placement to make return COM/COL arrangements. The customer will be responsible for all COM/COL return delivery charges.

2. The yardage figures shown throughout the price list are estimates only. Calculations are based on 54" wide material with no repeat and cut in the woven way cutting direction for a single chair. For specific yardage based on width of material, chair model, and quantity, please contact Sales Support.

3. For large quantity orders please contact Sales Support for more precise yardage requirement. Actual yardage requirement per chair often decreases with larger orders.

4. To calculate COM yardage, use the chart below as a guide and add appropriate amounts to the generic yardage requirements listed in the pricer.

FABRIC		2"-14"	15"-27"	28"-36"
WIDTH	GENERIC YARDAGE	REPEAT	REPEAT	REPEAT
54"		+20%	+30%	+40%

5. COL: Leather quality can vary depending on the size of the hides. Larger hides (50 to 60 sq. ft.) tend to be higher quality and yield. Smaller hides (40 to 50 sq. ft.) tend to have more quality issues that may cause smaller yields, requiring the need for additional hides to be ordered.

6. For all COL orders, 9to5 Seating cannot take responsibility for the need to order additional COL due to quality issues and related small material yields.

# Customer's Own Material/Leather Form

All COM textiles received at 9to5 Seating must be clearly marked with customer's name, purchase order number, 9to5 Seating sales order number (if available) and any special instructions for application of textile. Send COM textiles to 9to5 Seating Attention: COM Department 3211 Jack Northrop Ave. Hawthorne, CA 90250. For pattern matching/alignment, please contact Customer Care 888-925-7328.

## PDF - ONLINE FORM

DATE:	ACCOUNT NUMBER:
DEALER NAME:	PURCHASE ORDER NUMBER:
ADDRESS	CITY/ZIP CODE
9T05 ORDER NUMBER (IF AVAILABLE)	PHONE NUMBER
MODEL NUMBER	DEALER CONTACT
QUANTITY	TRACKING # (IF AVAILABLE)

## TEXTILE INFORMATION

MILL	FABRIC NAME/NUMBER
FABRIC COLOR	TOTAL YARDAGE SHIPPED

## APPLICATION

IS THERE A DESIRED TOP AND BOTTOM TO THE FABRIC?	IS THE FABRIC STRIPE OR TWO-COLOR PLAID?
YES   NO	YES   NO

## CHECK APPROPRIATE BOX FOR YOUR CHOICE OF FABRIC DIRECTION

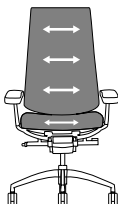
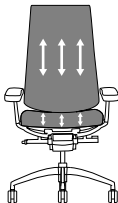
<b>HORIZONTAL</b> <input type="checkbox"/>	
<b>VERTICAL</b> <input type="checkbox"/>	

TOP
<p>ATTACH SAMPLE TEXTILE HERE WITH DESIRED FACE AND DIRECTION DISPLAYED. IF THERE IS A PATTERN OR REPEAT, THE SAMPLE SHOULD BE LARGE ENOUGH TO SHOW ENTIRE REPEAT.</p>
BOTTOM

Upon receipt of COM textile, a production date will be given to the order and you will receive an acknowledgment by fax or e-mail. After 90 days from when the order ships, any excess COM/COL material will be recycled.

# CAL TB 133 Fire Code

9to5 Seating's entire line of office seating meets California Technical Bulletin 117-2013 (CAL TB 117-2013) which has been in effect since January 1, 2015. This is a standard by which upholstered furniture has been tested for approval to meet a minimum fire standard. 9to5 Seating's standard product is not designed to meet California Technical Bulletin 133. However, upon special request, most 9to5 Seating products can be manufactured to meet the California Technical Bulletin 133 (CAL TB 133).

## CAL TB 133

CAL TB 133 is the standard of furniture flammability required by the California Bureau of Home Furnishings and Thermal Insulation for furniture used in public buildings. New requirements proposed for furniture used in public buildings include: healthcare facilities, convalescent homes, public assembly areas of hotels and motels, hospitals, board and care homes, stadiums, licensed child care facilities, prisons and jails

## CAL TB 133 Test

CAL TB 133 is a full-scale fire test for furniture manufactured for use in public buildings. The standards do not specify how to construct furniture, but only how it should perform when tested by the following procedures: A finished piece of furniture, never single components, is placed in a 10' x 12' x 8' chamber and is tested by applying a gas flame for 80 seconds. Then measurements are taken for the rate and amount of heat generated, temperature of the test room while furniture is burning, smoke capacity, amount of carbon monoxide generated and mass loss of the furniture for one hour or until the fire is completely extinguished.

A solution to pass this fire standard test is to sandwich a fire blocking liner between the foam and fabric of our chairs. This liner acts as a "fire extinguisher" by smothering the flame. As a response to CAL TB 133, and in order to meet customers' needs, 9to5 Seating has designed a variety of models and fabrics that can be combined to meet this new standard.

## CAL 133 Models

The following models when combined with approved textiles and blocker meet the CAL 133 standard. All plastic models of Shuttle and Bella are also approved.

### Acclaim: 2780

Agent: 1425, 1426, 1428, 1660, 1666, 1668

Bella: 1310, 1315, 1320, 1325, 1326, 1328, 1360, 1365, 1370, 1375, 1376, 1378

Bristol: 2360, 2366, 2368, 2380

Cosmo: 3220, 3230, 3250, 3260, 3250-GT

Cydia: 3300, 3300-GT, 3310, 3310-GT, 3306, 3308

Dash: 1130, 1131, 1134, 1135

Diddy: 2450, 2450-GT, 2450 R2

HÅG Capisco: 8106

Kelley: 1060, 1066, 1070, 1076

Link: 1410, 1415

Logic: 1725, 1726, 1728, 1760, 1766, 1768, 1780, 1790

Neo: 3160, 3166, 3168

Neo Lite: 3150, 3156, 3158

Shuttle: 1210, 1215, 1230, 1250, 1260, 1265, 1280

Sophie: 8102, 8103, 8104, 8111, 8112, 8113, 8118, 8119, 8122, 8123

Strata: 1545, 1546, 1548, 1555, 1560, 1580, 1560-GT, 1566, 1568, 1561, 1563

Vault: 1460, 1466, 1468, 1480

Zoom: 1115, 1125, 1126, 1128

## COM CAL TB 133

COM compliance for CAL 133 models listed above can be determined by specifying upholstery with the exact characteristics as approved 9to5 Seating fabrics or by conducting a full chair burn test. The non-discountable test fee for each chair-fabric combination is \$500 net.

## CAL TB 133 Upcharge

- 1 – 49 chairs: \$100 List upcharge per seat
- 50+ chairs: \$50 List upcharge per seat

## To Order CAL TB 133

Clearly specify CAL TB 133 on order, choose your desired fabric, from options above, then add the indicated amount above to the standard list price. Standard lead times apply.

## To Check Purchased Seating For CAL 133

To determine whether your current 9to5 Seating chair meets CAL TB 133, or to check an order you have recently received, check the bottom of the chair seat pan for the label shown below.

If your chair does not show this tag below, then your chair does NOT meet CAL TB 133.

### NOTICE

This article is manufactured for use in public occupancies and meets the flammability requirements of California Bureau of Home Furnishings Technical Bulletin 133. Care should be exercised near open flame or with burning cigarettes.

# Two-Tone Options

## Two-Tone Contrasting Textiles

When multiple textiles are selected on a single chair, clearly indicate your selection for both the seat or the back only on your purchase order. All fabric-upholstered chairs may be ordered with two-tone upholstery for no additional charge, except for some series including Ellie, Koble, Lilly, Jax and Sophie series. **For Koble, Lilly, Jax, Ellie and Sophie, there is a \$100 list upcharge per item.** For two-tone with any chairs, if the two upholstery selections are of different grades, the chair will price at the higher of the two grades.

## Available on these models:

Acclaim, Agent, Bella, Bristol, Clary, Core, Cortina, Cosmo, Dash, Ellie, HÅG Capisco, HÅG Celi, HÅG Tion, Jax, Koble, Lilly, Link, Logic, Shuttle, Sol, Sophie, Tori and Vox.



Ellie-Two Tone Option (Only Available for Ellie)



Reference for Lilly or Jax collections

# Custom Embroidery Form

Custom embroidery is a great way to display your company logo on upholstered chair backs. Embroidery can be done in multiple colors, shapes and sizes to suit your needs for a very reasonable cost and lead time. To obtain a quote for embroidered upholstery, please fill out the adjacent form as completely as possible. You will need a graphic file, preferable in AI, EPS or other graphic format. Generally, higher resolution art (greater than 300 dpi) will be easier to work with. There will be a set-up charge to create a digitized file if you do not have one available. We will also need a PMS color number for each color thread required. 9to5 Seating is not responsible for poorly digitized files or graphic files from the requestor. If the logo is NOT to be in the back center; the location of the logo needs to be specified as an offset from the center of the back, vertically and horizontally. See form.

Keep in mind, embroidery is not a one-to-one replacement for printing, patches or heat transfer vinyl lettering. Embroidery thread is heavier, stronger and tighter density than the surrounding fabric and may pull or pucker on loosely woven fabric. Embroidery will always look best on strong, closely knit fabrics or vinyl. It is best to always get a sample for approval before placing the full production order.

All logos are trademarks of their respective owners. 9to5 Seating is not responsible for obtaining permission or use of copyrighted logos. Before you use, reproduce or distribute in any manner, you must first receive the express permission of the holder of the copyright or trademark of that logo. Failure to obtain such permission is a violation under international law.

Note: Dimensional tolerance of logo placement is  $\pm 1/2$ " vertical and  $\pm 1/4$ " horizontal.

# Custom Embroidery Form

PLEASE SEND A COMPLETED PHOTOCOPY OF THIS PAGE TO 9T05 SEATING

FILLABLE FORMS LOCATED ON 9T05SEATING.COM/DOWNLOADS

DATE:	ACCOUNT NUMBER:
DEALER NAME:	PURCHASE ORDER NUMBER:
DEALER CONTACT NAME:	CITY/ZIP CODE
PROJECT(END USER):	PHONE NUMBER
MODEL NUMBER	DEALER CONTACT
TOTAL PROJECT QUANTITY	TOTAL PROJECT NET:

COMMENTS:

IS THE EMBROIDERY FOR A BID?	IS A SAMPLE REQUIRED FOR CUSTOMER REVIEW PRIOR TO PRODUCTION OF ORDER?
YES   NO	YES   NO

IS A LOGO/GRAPHIC FILE AVAILABLE?	LOGO/GRAPHIC FILE TYPE?
YES   NO	AI   EPS   PDF   JPEG   PNG   OTHER:

STANDARD MODEL	QTY	HEIGHT	WIDTH	COLOR/PMS EQUIVALENT	TEXTILE MILL/PATTERN/COLOR

LOGO/IMAGE LOCATION (FROM LOGO CENTER TO CHAIR BACK CENTER)

VERTICAL OFFSET FROM CENTER:	HORIZONTAL OFFSET FROM CENTER:
INCHES	INCHES

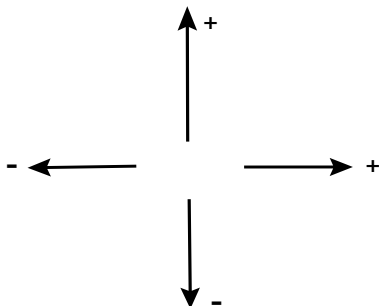

TOP

---

ATTACH SAMPLE LOGO/GRAPHIC HERE.

---

BOTTOM

# NEW FOR 2025

## Unparalleled Performance with Impact



AVAILABLE NOW

### Tori Mid-Back & Stool

- Wraparound back design
- Mesh back or upholstered back models
- Seat slider and lumbar

See pages 144-147

**NEW FOR 2025**

**Lilly is Growing**

**AVAILABLE NOW**

**Lilly Ottoman  
& Lounge**

- New ottoman adds additional comfort and rounds out our most popular lounge series

See pages 88-95



# Acclaim

CONTEMPORARY EUROPEAN  
STYLING YET SUBTLE DETAILING

## HIGH-BACK

- Task, conference and executive seating
- Sleek rectilinear design with fine stitching
- Dual density foam provides firm profile with plush comfortable interior
- Polished arm with upholstered pad available
- Warranted to 300 lbs.

Webpage



GSA SIN # 33721

### MODEL / CONTROL

### ARMS MATERIAL

### DIMENSIONS

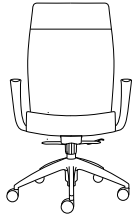

#### 2780 / Y3

##### High-Back Full Synchro Tilt

- 3-position tilt lock
- 2:1 back-to-seat tilt ratio
- Center knob tension adjustment
- 360° swivel
- Pneumatic cylinder height adjustment

	A	B/COM	C	D	E	F	G	L3/COL	L4	L5
A00	\$951	\$1016	\$1071	\$1126	\$1229	\$1331	\$1421	\$1201	\$1251	\$1446
A10	\$1061	\$1126	\$1181	\$1236	\$1339	\$1441	\$1531	\$1311	\$1361	\$1556
A19	\$1186	\$1251	\$1306	\$1361	\$1464	\$1566	\$1656	\$1436	\$1486	\$1681
A23B/G	\$1046	\$1111	\$1166	\$1221	\$1324	\$1426	\$1516	\$1296	\$1346	\$1541
A27	\$1186	\$1251	\$1306	\$1361	\$1464	\$1566	\$1656	\$1436	\$1486	\$1681
A36	\$1076	\$1141	\$1196	\$1251	\$1354	\$1456	\$1546	\$1326	\$1376	\$1571
A37	\$1091	\$1156	\$1211	\$1266	\$1369	\$1471	\$1561	\$1341	\$1391	\$1586

WIDTH: 27.5  
DEPTH: 26.5  
HEIGHT: 44.0-48.5  
SEAT WIDTH: 20.0  
SEAT DEPTH: 17.0  
SEAT HEIGHT: 18.0-23.0  
SEAT HEIGHT W/  
SEAT SLIDER: 19.0-24.0  
BACK WIDTH: 21.5  
BACK HEIGHT: 26.5  
COM: 1.9 YD  
COL: 39.0 SQ FT  
WEIGHT: 48.0 LB

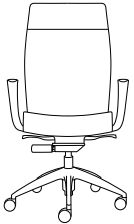

#### 2780 / Y2

##### High-Back Heavy Duty Synchro Tilt

- 4-position tilt lock
- Side knob tension adjustment
- 2:1 back-to-seat tilt ratio
- 360° swivel
- Pneumatic cylinder height adjustment

	A	B/COM	C	D	E	F	G	L3/COL	L4	L5
A00	\$981	\$1046	\$1101	\$1156	\$1259	\$1361	\$1451	\$1231	\$1281	\$1476
A10	\$1091	\$1156	\$1211	\$1266	\$1369	\$1471	\$1561	\$1341	\$1391	\$1586
A19	\$1216	\$1281	\$1336	\$1391	\$1494	\$1596	\$1686	\$1466	\$1516	\$1711
A23B/G	\$1076	\$1141	\$1196	\$1251	\$1354	\$1456	\$1546	\$1326	\$1376	\$1571
A27	\$1216	\$1281	\$1336	\$1391	\$1494	\$1596	\$1686	\$1466	\$1516	\$1711
A36	\$1106	\$1171	\$1226	\$1281	\$1384	\$1486	\$1576	\$1356	\$1406	\$1601
A37	\$1121	\$1186	\$1241	\$1296	\$1399	\$1501	\$1591	\$1371	\$1421	\$1616

WIDTH: 27.5  
DEPTH: 26.5  
HEIGHT: 44.0-49.0  
SEAT WIDTH: 20.0  
SEAT DEPTH: 17.0  
SEAT HEIGHT: 18.0-23.0  
SEAT HEIGHT W/  
SEAT SLIDER: 19.0-24.0  
BACK WIDTH: 21.5  
BACK HEIGHT: 26.5  
COM: 1.9 YD  
COL: 39.0 SQ FT  
WEIGHT: 44.0 LB

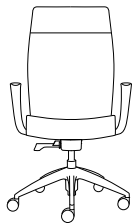

#### 2780 / W2

##### High-Back Weight Balanced Synchro Tilt

- Automatic tension adjustment with option to modify
- Tilt-limiter 4-position lock
- 3:1 back-to-seat tilt ratio
- 360° swivel
- Pneumatic cylinder height adjustment

	A	B/COM	C	D	E	F	G	L3/COL	L4	L5
A00	\$996	\$1061	\$1116	\$1171	\$1274	\$1376	\$1466	\$1246	\$1296	\$1491
A10	\$1106	\$1171	\$1226	\$1281	\$1384	\$1486	\$1576	\$1356	\$1406	\$1601
A19	\$1231	\$1296	\$1351	\$1406	\$1509	\$1611	\$1701	\$1481	\$1531	\$1726
A23B/G	\$1091	\$1156	\$1211	\$1266	\$1369	\$1471	\$1561	\$1341	\$1391	\$1586
A27	\$1231	\$1296	\$1351	\$1406	\$1509	\$1611	\$1701	\$1481	\$1531	\$1726
A36	\$1121	\$1186	\$1241	\$1296	\$1399	\$1501	\$1591	\$1371	\$1421	\$1616
A37	\$1136	\$1201	\$1256	\$1311	\$1414	\$1516	\$1606	\$1386	\$1436	\$1631

WIDTH: 27.5  
DEPTH: 26.5  
HEIGHT: 44.0-48.5  
SEAT WIDTH: 20.0  
SEAT DEPTH: 17.0  
SEAT HEIGHT: 18.0-22.5  
BACK WIDTH: 21.5  
BACK HEIGHT: 26.5  
COM: 1.9 YD  
COL: 39.0 SQ FT  
WEIGHT: 44.0 LB

# Acclaim





## HIGH-BACK

Webpage

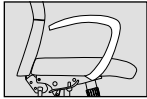
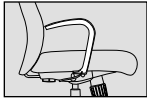
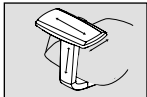

GSA SIN # 33721

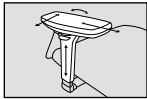

### ARM OPTIONS

CODE	DESCRIPTION	PRICE	
<b>A10</b>	Soff Touch C-Shaped Arm	+\$110	
<b>A19</b>	Polished Aluminum C-Shape Arm	+\$235	
<b>A23B</b>	6-Way Height Adjustable Arm w/ Sliding Pad • Black	+\$95	
<b>A23D</b>	6-Way Height Adjustable Arm w/ Sliding Pad • Dove Gray	+\$95	
<b>A27</b>	Polished Aluminum C-Shape Arm with Matching Upholstered Pad	+\$235	
<b>A36</b>	Height Adjustable Pivot/Slide Arm	+\$125	
<b>A37</b>	Height/Width Adjustable Pivot/Slide Arm	+\$140	

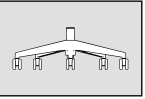
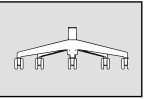
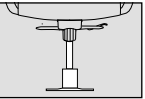
### BASE OPTIONS

CODE	DESCRIPTION	PRICE	
<b>BA11B</b>	27" Mid-Profile Nylon • Black	+\$0	
<b>BA11G</b>	27" Mid-Profile Nylon • Graphite	+\$0	
<b>BA12B</b>	27" Mid-Profile Aluminum Base • Black	+\$110	
<b>BA12P</b>	27" Mid-Profile Aluminum Base • Polished • C7 Chrome-Accented Casters Standard with Polished Base	+\$110	
<b>JB1</b>	Jury Base	+\$300	

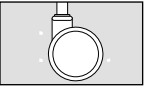
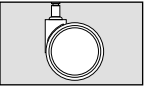
### CASTER OPTIONS

CODE	DESCRIPTION	PRICE	
<b>C6</b>	Large Diameter Carpet Casters	+\$0	
<b>C6S</b>	Large Diameter Hard Floor and Carpet Casters	+\$35	
<b>C7</b>	Chrome-Accented Hard Floor and Carpet Casters	+\$0	

### ADDITIONAL OPTIONS

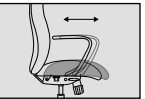
CODE	DESCRIPTION	PRICE	
<b>SS</b>	Seat Slider 2.5" • Side Paddle Activated • Factory Installed • For Models with Y2 and Y3 Controls Only	+\$60	



# Agent

LENDING COMFORT, DURABILITY,  
AND VALUE TO EVERY PROJECT

## LOW-BACK

- Task, conference and stool seating
- Ratchet back lumbar height adjustment on select models
- Poly outer back
- Low- or mid-back models
- Warranted to 300 lbs.

Webpage









GSA SIN # 33721

### MODEL / CONTROL

### ARMS MATERIAL

### DIMENSIONS

MODEL / CONTROL	ARMS	MATERIAL									DIMENSIONS	
			A	B/COM	C	D	E	F	G	L4	L5	
 <p><b>1425 / B2</b> Low-Back Basic Task</p> <ul style="list-style-type: none"> <li>• 360-degree swivel</li> <li>• Pneumatic seat height adjustment</li> </ul>	A00		\$478	\$508	\$538	\$578	\$628	\$683	\$753	\$888	\$968	WIDTH: 27.0
	A4		\$578	\$608	\$638	\$678	\$728	\$783	\$853	\$988	\$1068	DEPTH: 26.5
	A5		\$593	\$623	\$653	\$693	\$743	\$798	\$868	\$1003	\$1083	HEIGHT: 31.5-36.0
	A6		\$638	\$668	\$698	\$738	\$788	\$843	\$913	\$1048	\$1128	SEAT WIDTH: 19.5
	A7		\$653	\$683	\$713	\$753	\$803	\$858	\$928	\$1063	\$1143	SEAT DEPTH: 15.5
	A16		\$603	\$633	\$663	\$703	\$753	\$808	\$878	\$1013	\$1093	SEAT HEIGHT: 17.5-22.0
	A36		\$603	\$633	\$663	\$703	\$753	\$808	\$878	\$1013	\$1093	BACK WIDTH: 16.5
	A37		\$618	\$648	\$678	\$718	\$768	\$823	\$893	\$1028	\$1108	BACK HEIGHT: 16.5
												COM: 0.8 YD
												WEIGHT: 33.0 LB
 <p><b>1425 / S2</b> Low-Back Swivel Tilt With Back Depth Adjustment</p> <ul style="list-style-type: none"> <li>• Adjustable back depth</li> <li>• Upright lock</li> <li>• Center knob tension adjustment</li> <li>• 360° swivel</li> <li>• Pneumatic cylinder height adjustment</li> </ul>	A00		\$523	\$553	\$583	\$623	\$673	\$728	\$798	\$933	\$1013	WIDTH: 27.0
	A4		\$623	\$653	\$683	\$723	\$773	\$828	\$898	\$1033	\$1113	DEPTH: 26.5
	A5		\$638	\$668	\$698	\$738	\$788	\$843	\$913	\$1048	\$1128	HEIGHT: 31.5-36.0
	A6		\$683	\$713	\$743	\$783	\$833	\$888	\$958	\$1093	\$1173	SEAT WIDTH: 19.5
	A7		\$698	\$728	\$758	\$798	\$848	\$903	\$973	\$1108	\$1188	SEAT DEPTH: 15.5
	A16		\$648	\$678	\$708	\$748	\$798	\$853	\$923	\$1058	\$1138	SEAT HEIGHT: 17.5-22.0
	A36		\$648	\$678	\$708	\$748	\$798	\$853	\$923	\$1058	\$1138	SEAT HEIGHT W/ SLIDER: 18.5-23
	A37		\$663	\$693	\$723	\$763	\$813	\$868	\$938	\$1073	\$1153	BACK WIDTH: 16.5
												BACK HEIGHT: 16.5
												COM: 0.8 YD
												COL: N/A
												WEIGHT: 35.0 LB
 <p><b>1425 / P1</b> Low-Back Posture Back</p> <ul style="list-style-type: none"> <li>• Ratchet back lumbar adjustment</li> <li>• Infinite back angle adjustment with free float</li> <li>• 360° swivel</li> <li>• Pneumatic seat height adjustment</li> </ul>	A00		\$563	\$593	\$623	\$663	\$713	\$768	\$838	\$973	\$1053	WIDTH: 27.0
	A4		\$663	\$693	\$723	\$763	\$813	\$868	\$938	\$1073	\$1153	DEPTH: 26.5
	A5		\$678	\$708	\$738	\$778	\$828	\$883	\$953	\$1088	\$1168	HEIGHT: 31.5-39.0
	A6		\$723	\$753	\$783	\$823	\$873	\$928	\$998	\$1133	\$1213	SEAT WIDTH: 19.5
	A7		\$738	\$768	\$798	\$838	\$888	\$943	\$1013	\$1148	\$1228	SEAT DEPTH: 15.5
	A16		\$688	\$718	\$748	\$788	\$838	\$893	\$963	\$1098	\$1178	SEAT HEIGHT: 17.5-22.0
	A36		\$688	\$718	\$748	\$788	\$838	\$893	\$963	\$1098	\$1178	SEAT HEIGHT W/ SLIDER: 18.5-23.0
	A37		\$703	\$733	\$763	\$803	\$853	\$908	\$978	\$1113	\$1193	BACK WIDTH: 16.5
												BACK HEIGHT: 16.5-19.5
												COM: 0.8 YD
												COL: N/A
												WEIGHT: 37.0 LB
 <p><b>1425 / R1</b> Low-Back Rocking Tilt</p> <ul style="list-style-type: none"> <li>• Ratchet back lumbar adjustment</li> <li>• Infinite back angle adjustment</li> <li>• Infinite tilt lock</li> <li>• Center knob tension adjustment</li> <li>• 360° swivel</li> <li>• Pneumatic cylinder height adjustment</li> </ul>	A00		\$573	\$603	\$633	\$673	\$723	\$778	\$848	\$983	\$1063	WIDTH: 27.0
	A4		\$673	\$703	\$733	\$773	\$823	\$878	\$948	\$1083	\$1163	DEPTH: 26.5
	A5		\$688	\$718	\$748	\$788	\$838	\$893	\$963	\$1098	\$1178	HEIGHT: 31.5-36.0
	A6		\$733	\$763	\$793	\$833	\$883	\$938	\$1008	\$1143	\$1223	SEAT WIDTH: 19.5
	A7		\$748	\$778	\$808	\$848	\$898	\$953	\$1023	\$1158	\$1238	SEAT DEPTH: 15.5
	A16		\$698	\$728	\$758	\$798	\$848	\$903	\$973	\$1108	\$1188	SEAT HEIGHT: 17.5-22.0
	A36		\$698	\$728	\$758	\$798	\$848	\$903	\$973	\$1108	\$1188	SEAT HEIGHT W/ SLIDER: 18.5-23.0
	A37		\$713	\$743	\$773	\$813	\$863	\$918	\$988	\$1123	\$1203	BACK WIDTH: 16.5
												BACK HEIGHT: 16.5-19.5
												COM: 0.8 YD
												COL: N/A
												WEIGHT: 33.0 LB
 <p><b>1425 / M1</b> Low-Back Multi-Function</p> <ul style="list-style-type: none"> <li>• Ratchet back lumbar adjustment</li> <li>• Infinite back angle adjustment</li> <li>• 6° forward tilt</li> <li>• Center knob tension adjustment</li> <li>• 360° swivel</li> <li>• Pneumatic cylinder height adjustment</li> </ul>	A00		\$623	\$653	\$683	\$723	\$773	\$828	\$898	\$1033	\$1113	WIDTH: 27.0
	A4		\$723	\$753	\$783	\$823	\$873	\$928	\$998	\$1133	\$1213	DEPTH: 26.5
	A5		\$738	\$768	\$798	\$838	\$888	\$943	\$1013	\$1148	\$1228	HEIGHT: 31.5-36.0
	A6		\$783	\$813	\$843	\$883	\$933	\$988	\$1058	\$1193	\$1273	SEAT WIDTH: 19.5
	A7		\$798	\$828	\$858	\$898	\$948	\$1003	\$1073	\$1208	\$1288	SEAT DEPTH: 15.5
	A16		\$748	\$778	\$808	\$848	\$898	\$953	\$1023	\$1158	\$1238	SEAT HEIGHT: 19.0-23.5
	A36		\$748	\$778	\$808	\$848	\$898	\$953	\$1023	\$1158	\$1238	SEAT HEIGHT W/ SLIDER: 20.0-24.5
	A37		\$763	\$793	\$823	\$863	\$913	\$968	\$1038	\$1173	\$1253	BACK WIDTH: 16.5
												BACK HEIGHT: 16.5-19.5
												COM: 0.8 YD
												COL: N/A
												WEIGHT: 43.0 LB
 <p><b>1425 / Y2</b> Low-Back Heavy Duty Synchro Tilt with Seat Slider</p> <ul style="list-style-type: none"> <li>• Ratchet back lumbar adjustment</li> <li>• Seat slider standard</li> <li>• 4-position tilt lock</li> <li>• Side knob tension control</li> <li>• 2:1 back-to-seat tilt ratio</li> <li>• 360° swivel</li> <li>• Pneumatic cylinder height adjustment</li> </ul>	A00		\$663	\$693	\$723	\$763	\$813	\$868	\$938	\$1073	\$1153	WIDTH: 27.0
	A4		\$763	\$793	\$823	\$863	\$913	\$968	\$1038	\$1173	\$1253	DEPTH: 26.5
	A5		\$778	\$808	\$838	\$878	\$928	\$983	\$1053	\$1188	\$1268	HEIGHT: 31.5-36.0
	A6		\$823	\$853	\$883	\$923	\$973	\$1028	\$1098	\$1233	\$1313	SEAT WIDTH: 19.5
	A7		\$838	\$868	\$898	\$938	\$988	\$1043	\$1113	\$1248	\$1328	SEAT DEPTH: 15.5
	A16		\$788	\$818	\$848	\$888	\$938	\$993	\$1063	\$1198	\$1278	SEAT HEIGHT: 19.0-23.5
	A36		\$788	\$818	\$848	\$888	\$938	\$993	\$1063	\$1198	\$1278	SEAT HEIGHT W/ SLIDER: 16.5
	A37		\$803	\$833	\$863	\$903	\$953	\$1008	\$1078	\$1213	\$1293	BACK WIDTH: 16.5
												BACK HEIGHT: 16.5-19.5
												COM: 0.8 YD
												WEIGHT: 35.0 LB

# Agent







## LOW-BACK

Webpage

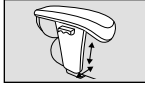

GSA SIN # 33721

### ARM OPTIONS

CODE	DESCRIPTION	PRICE	
<b>A4</b>	Height Adjustable Arm	+\$100	
<b>A5</b>	Height/Width Adjustable Arm	+\$115	
<b>A6</b>	Height Adjustable Pivot Slide Arm	+\$160	
<b>A7</b>	Height/Width Adjustable Pivot Slide Arm	+\$175	
<b>A16</b>	Soft Touch C-Shape Arm	+\$125	
<b>A36</b>	Height Adjustable Pivot/Slide Arm	+\$125	
<b>A37</b>	Height/Width Adjustable Pivot/Slide Arm	+\$140	



### STOOL OPTIONS

CODE	DESCRIPTION	PRICE	
<b>CY30</b>	8" Stool • Seat Height: 22"-30" • Use for work surfaces up to 36" • Available with B2 or P1	+\$125	
<b>CY36</b>	10" Stool • Seat Height: 25"-36" • Use for work surfaces up to 42" • Available with B2 or P1	+\$125	

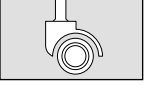

### BASE OPTIONS

CODE	DESCRIPTION	PRICE	
<b>BA1B</b>	26" Nylon Base • Black	+\$0	

### CASTER OPTIONS

CODE	DESCRIPTION	PRICE	
<b>C1</b>	Carpet Casters	+\$0	
<b>C1S</b>	Hard Floor and Carpet Casters	+\$35	
<b>C2S</b>	Decompression Hard Floor and Soft Carpet Caster	+\$35	

### ADDITIONAL OPTIONS

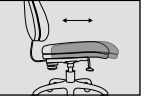
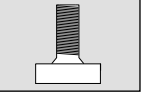
CODE	DESCRIPTION	PRICE	
<b>EF1</b>	1" Extra Foam on Seat • If EF1 is selected, cannot use MF1 in addition.	+\$30	
<b>MF1</b>	1" Visco Elastic Memory Foam on Seat. • If MF1 is selected, cannot use EF1 in addition	+\$50	
<b>SS</b>	Seat Slider 2.5" • Side Paddle Activated • Factory Installed • Available with S2, P1, R1 & M1 • Seat slider not available with stools	+\$60	
<b>BT</b>	Replace Knob with Bolt • For B2 or S2 Controls Only	+\$15	



# Agent

LENDING COMFORT, DURABILITY,  
AND VALUE TO EVERY PROJECT

## MID-BACK

- Task, conference and stool seating
- Ratchet back lumbar height adjustment on select models
- Poly outer back
- Low- or mid-back models
- Warranted to 300 lbs.

Webpage



GSA SIN # 33721

### MODEL / CONTROL

### ARMS MATERIAL

### DIMENSIONS



#### 1660 / B2

##### Mid-Back Basic Task with Back Depth Adjustment

- 360° swivel
- Pneumatic cylinder height adjustment

	A	B/COM	C	D	E	F	G
A00	\$553	\$588	\$618	\$668	\$718	\$768	\$833
A4	\$653	\$688	\$718	\$768	\$818	\$868	\$933
A5	\$668	\$703	\$733	\$783	\$833	\$883	\$948
A6	\$713	\$748	\$778	\$828	\$878	\$928	\$993
A7	\$728	\$763	\$793	\$843	\$893	\$943	\$1008
A16	\$678	\$713	\$743	\$793	\$843	\$893	\$958
A36	\$678	\$713	\$743	\$793	\$843	\$893	\$958
A37	\$693	\$728	\$758	\$808	\$858	\$908	\$973

WIDTH:	26.5
DEPTH:	26.5
HEIGHT:	40.0-44.5
SEAT WIDTH:	22.0
SEAT DEPTH:	17.0
SEAT HEIGHT:	18.5-23.0
BACK WIDTH:	19.5
BACK HEIGHT:	23.0-26.0
COM:	1.0 YD
WEIGHT:	40.0 LB



#### 1660 / S2

##### Mid-Back Swivel Tilt with Back Depth Adjustment

- Adjustable back depth
- Upright lock
- Center knob tension adjustment
- 360° swivel
- Pneumatic cylinder height adjustment

	A	B/COM	C	D	E	F	G
A00	\$598	\$633	\$663	\$713	\$763	\$813	\$878
A4	\$698	\$733	\$763	\$813	\$863	\$913	\$978
A5	\$713	\$748	\$778	\$828	\$878	\$928	\$993
A6	\$758	\$793	\$823	\$873	\$923	\$973	\$1038
A7	\$773	\$808	\$838	\$888	\$938	\$988	\$1053
A16	\$723	\$758	\$788	\$838	\$888	\$938	\$1003
A36	\$723	\$758	\$788	\$838	\$888	\$938	\$1003
A37	\$738	\$773	\$803	\$853	\$903	\$953	\$1018

WIDTH:	26.5
DEPTH:	26.5
HEIGHT:	40.0-44.5
SEAT WIDTH:	22.0
SEAT DEPTH:	17.0
SEAT HEIGHT:	18.5-23.0
SEAT HEIGHT W/ SEAT SLIDER:	19.5-24.0
BACK WIDTH:	19.5
BACK HEIGHT:	23.0-26.0
COM:	1.0 YD
COL:	N/A
WEIGHT:	42.0 LB



#### 1660 / P1

##### Mid-Back Posture Back

- Infinite back angle adjustment with free float
- 360° swivel
- Pneumatic cylinder height adjustment

	A	B/COM	C	D	E	F	G
A00	\$638	\$673	\$703	\$753	\$803	\$853	\$918
A4	\$738	\$773	\$803	\$853	\$903	\$953	\$1018
A5	\$753	\$788	\$818	\$868	\$918	\$968	\$1033
A6	\$798	\$833	\$863	\$913	\$963	\$1013	\$1078
A7	\$813	\$848	\$878	\$928	\$978	\$1028	\$1093
A16	\$763	\$798	\$828	\$878	\$928	\$978	\$1043
A36	\$763	\$798	\$828	\$878	\$928	\$978	\$1043
A37	\$778	\$813	\$843	\$893	\$943	\$993	\$1058

WIDTH:	26.5
DEPTH:	26.5
HEIGHT:	40.0-47.5
SEAT WIDTH:	22.0
SEAT DEPTH:	17.0
SEAT HEIGHT:	18.5-23.0
SEAT HEIGHT W/ SEAT SLIDER:	19.5-24.0
BACK WIDTH:	19.5
BACK HEIGHT:	23.0-26.0
COM:	1.0 YD
COL:	1.0 YD
WEIGHT:	44.0 LB



#### 1660 / R1

##### Mid-Back Rocking Tilt

- Infinite back angle adjustment
- Infinite tilt lock
- Center knob tension adjustment
- 360° swivel
- Pneumatic cylinder height adjustment

	A	B/COM	C	D	E	F	G
A00	\$648	\$683	\$713	\$763	\$813	\$863	\$928
A4	\$748	\$783	\$813	\$863	\$913	\$963	\$1028
A5	\$763	\$798	\$828	\$878	\$928	\$978	\$1043
A6	\$808	\$843	\$873	\$923	\$973	\$1023	\$1088
A7	\$823	\$858	\$888	\$938	\$988	\$1038	\$1103
A16	\$773	\$808	\$838	\$888	\$938	\$988	\$1053
A36	\$773	\$808	\$838	\$888	\$938	\$988	\$1053
A37	\$788	\$823	\$853	\$903	\$953	\$1003	\$1068

WIDTH:	26.5
DEPTH:	26.5
HEIGHT:	40.0-47.5
SEAT WIDTH:	22.0
SEAT DEPTH:	16.0
SEAT HEIGHT:	18.5-23.0
SEAT HEIGHT W/ SEAT SLIDER:	19.5-24.0
BACK WIDTH:	19.5
BACK HEIGHT:	23.0-26.0
COM:	1.0 YD
COL:	1.0 YD
WEIGHT:	46.0 LB



#### 1660 / M1

##### Mid-Back Multi-Function

- Ratchet back lumbar adjustment
- Infinite back angle adjustment
- 6° forward tilt
- Center knob tension adjustment
- 360° swivel
- Pneumatic cylinder height adjustment

	A	B/COM	C	D	E	F	G
A00	\$698	\$733	\$763	\$813	\$863	\$913	\$978
A4	\$798	\$833	\$863	\$913	\$963	\$1013	\$1078
A5	\$813	\$848	\$878	\$928	\$978	\$1028	\$1093
A6	\$858	\$893	\$923	\$973	\$1023	\$1073	\$1138
A7	\$873	\$908	\$938	\$988	\$1038	\$1088	\$1153
A16	\$823	\$858	\$888	\$938	\$988	\$1038	\$1103
A36	\$823	\$858	\$888	\$938	\$988	\$1038	\$1103
A37	\$838	\$873	\$903	\$953	\$1003	\$1053	\$1118

WIDTH:	26.5
DEPTH:	26.5
HEIGHT:	38.5-44.0
SEAT WIDTH:	22.0
SEAT DEPTH:	17.5-20.5
SEAT HEIGHT:	18.5-23.0
SEAT HEIGHT W/ SEAT SLIDER:	19.5-24.0
BACK WIDTH:	19.5
BACK HEIGHT:	23.0-26.0
COM:	1.0 YD
COL:	1.0 YD
WEIGHT:	48.0 LB

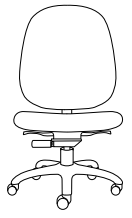

#### 1660 / Y2

##### Mid-Back Heavy Duty Synchro Tilt

- Ratchet back lumbar adjustment
- Seat slider standard
- 4-position tilt lock
- Side knob tension control
- 2:1 back-to-seat tilt ratio
- 360° swivel
- Pneumatic cylinder height adjustment

	A	B/COM	C	D	E	F	G
A00	\$738	\$773	\$803	\$853	\$903	\$953	\$1018
A4	\$838	\$873	\$903	\$953	\$1003	\$1053	\$1118
A5	\$853	\$888	\$918	\$968	\$1018	\$1068	\$1133
A6	\$898	\$933	\$963	\$1013	\$1063	\$1113	\$1178
A7	\$913	\$948	\$978	\$1028	\$1078	\$1128	\$1193
A16	\$863	\$898	\$928	\$978	\$1028	\$1078	\$1143
A36	\$863	\$898	\$928	\$978	\$1028	\$1078	\$1143
A37	\$878	\$913	\$943	\$993	\$1043	\$1093	\$1158

WIDTH:	26.5
DEPTH:	26.5
HEIGHT:	38.5-44.0
SEAT WIDTH:	22.0
SEAT DEPTH:	17.5-20.5
SEAT HEIGHT:	18.5-21.5
BACK WIDTH:	19.5
BACK HEIGHT:	23.0-26.0
COM:	1.0 YD
WEIGHT:	48.0 LB

# Agent





## MID-BACK

Webpage



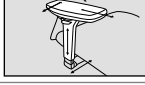

GSA SIN # 33721

### ARM OPTIONS

CODE	DESCRIPTION	PRICE	
<b>A4</b>	Height Adjustable Arm	+\$100	
<b>A5</b>	Height/Width Adjustable Arm	+\$115	
<b>A6</b>	Height Adjustable Pivot Slide Arm	+\$160	
<b>A7</b>	Height/Width Adjustable Pivot Slide Arm	+\$175	
<b>A16</b>	Soft Touch C-Shape Arm	+\$125	
<b>A36</b>	Height Adjustable Pivot/Slide Arm	+\$125	
<b>A37</b>	Height/Width Adjustable Pivot/Slide Arm	+\$140	
<b>A90</b>	Height/Width Adjustable Breakaway Arm	\$240	



### STOOL OPTIONS

CODE	DESCRIPTION	PRICE	
<b>CY30</b>	8" Stool • Seat Height: 22"-30" • Use for work surfaces up to 36" • Available with B2 or P1	+\$125	
<b>CY36</b>	10" Stool • Seat Height: 25"-36" • Use for work surfaces up to 42" • Available with B2 or P1	+\$125	

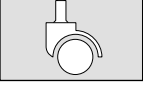
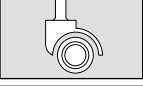

### BASE OPTIONS

CODE	DESCRIPTION	PRICE	
<b>BA1B</b>	26" Nylon Base • Black	+\$0	

### CASTER OPTIONS

CODE	DESCRIPTION	PRICE	
<b>C1</b>	Carpet Casters	+\$0	
<b>C1S</b>	Hard Floor and Carpet Casters	+\$35	
<b>C2S</b>	Decompression Hard Floor and Soft Carpet Caster	+\$35	

### ADDITIONAL OPTIONS

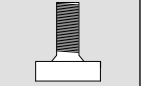
CODE	DESCRIPTION	PRICE	
<b>EF1</b>	1" Extra Foam on Seat • If EF1 is selected, cannot use MF1 in addition.	+\$30	
<b>MF1</b>	1" Visco Elastic Memory Foam on Seat. • If MF1 is selected, cannot use EF1 in addition	+\$50	
<b>SS</b>	Seat Slider 2.5" • Side Paddle Activated • Factory Installed • Available with S2, P1, R1 & M1 • Seat slider not available with stools	+\$60	
<b>BT</b>	Replace Knob with Bolt • For B2 or S2 Controls Only	+\$15	



# Bella

NAME YOUR GAME, BELLA IS  
READY TO PLAY.

## NESTING

- Multi-purpose seating, including stacking, nesting, task and task stool models
- Perfect for collaborative, meeting, training and break room spaces
- Plastic, upholstered or mesh back options
- Warranted to 300 lbs.

Webpage



GSA SIN # 33721

MODEL / CHAIR TYPE	ARMS	MATERIAL								DIMENSIONS		
<p><b>1310 / FRM</b> Plastic Back - PB &amp; Plastic Seat - PS Nesting</p> <ul style="list-style-type: none"> <li>• Flip-up seat for nesting and compact storage</li> <li>• Armless or armed</li> </ul>		<b>P</b>									<b>ARMS</b>	<b>ARMLESS</b>
	A00	\$417									WIDTH: 21.0	25.0
	A12	\$477									DEPTH: 26.0	26.0
											HEIGHT: 33.0	33.0
											SEAT WIDTH: 18.0	18.0
											SEAT DEPTH: 16.0	16.0
											SEAT HEIGHT: 18.0	18.0
											BACK WIDTH: 19.0	19.0
											BACK HEIGHT: 17.5	17.5
											COM: N/A	N/A
											COL: N/A	N/A
											WEIGHT: 19.0 LB	22.0 LB
<p><b>1310 / FRM</b> Plastic Back - PB &amp; Upholstered Seat - US Nesting</p> <ul style="list-style-type: none"> <li>• Flip-up seat for nesting and compact storage</li> <li>• Armless or armed</li> </ul>		<b>A</b>	<b>B/COM</b>	<b>C</b>	<b>D</b>	<b>E</b>	<b>F</b>	<b>G</b>			<b>ARMS</b>	<b>ARMLESS</b>
	A00	\$477	\$502	\$532	\$572	\$617	\$667	\$727			WIDTH: 21.0	25.0
	A12	\$537	\$562	\$592	\$632	\$677	\$727	\$787			DEPTH: 26.0	26.0
												HEIGHT: 33.0
											SEAT WIDTH: 18.0	18.0
											SEAT DEPTH: 16.0	16.0
											SEAT HEIGHT: 18.5	18.5
											BACK WIDTH: 19.0	19.0
											BACK HEIGHT: 17.5	17.5
											COM: 0.7 YD	0.7 YD
											COL: N/A	N/A
											WEIGHT: 21.0 LB	24.0 LB
<p><b>1310 / FRM</b> Mesh Back - MB &amp; Plastic Seat - PS Nesting</p> <ul style="list-style-type: none"> <li>• Flip-up seat for nesting and compact storage</li> <li>• Armless or armed</li> <li>• Three mesh colors in black plastic</li> </ul>		<b>P</b>									<b>ARMS</b>	<b>ARMLESS</b>
	A00	\$482									WIDTH: 21.0	25.0
	A12	\$542									DEPTH: 26.0	26.0
												HEIGHT: 33.0
											SEAT WIDTH: 18.0	18.0
											SEAT DEPTH: 16.0	16.0
											SEAT HEIGHT: 18.0	18.0
											BACK WIDTH: 19.0	19.0
											BACK HEIGHT: 17.5	17.5
											COM: N/A	N/A
											COL: N/A	N/A
											WEIGHT: 19.0 LB	22.0 LB
<p><b>1310 / FRM</b> Mesh Back - MB &amp; Upholstered Seat - US Nesting</p> <ul style="list-style-type: none"> <li>• Flip-up seat for nesting and compact storage</li> <li>• Armless or armed</li> <li>• Three mesh colors in black plastic</li> </ul>		<b>A</b>	<b>B/COM</b>	<b>C</b>	<b>D</b>	<b>E</b>	<b>F</b>	<b>G</b>			<b>ARMS</b>	<b>ARMLESS</b>
	A00	\$542	\$567	\$597	\$637	\$682	\$732	\$792			WIDTH: 21.0	25.0
	A12	\$602	\$632	\$662	\$702	\$747	\$797	\$857			DEPTH: 26.0	26.0
												HEIGHT: 33.0
											SEAT WIDTH: 18.0	18.0
											SEAT DEPTH: 16.0	16.0
											SEAT HEIGHT: 18.5	18.5
											BACK WIDTH: 19.0	19.0
											BACK HEIGHT: 17.5	17.5
											COM: 0.7 YD	0.7 YD
											COL: N/A	N/A
											WEIGHT: 21.0 LB	24.0 LB
<p><b>1310 / FRM</b> Upholstered Back - UB &amp; Upholstered Seat - US Nesting</p> <ul style="list-style-type: none"> <li>• Flip-up seat for nesting and compact storage</li> <li>• Armless or armed</li> </ul>		<b>A</b>	<b>B/COM</b>	<b>C</b>	<b>D</b>	<b>E</b>	<b>F</b>	<b>G</b>			<b>ARMS</b>	<b>ARMLESS</b>
	A00	\$537	\$562	\$592	\$632	\$677	\$727	\$787			WIDTH: 21.0	25.0
	A12	\$597	\$622	\$652	\$692	\$737	\$787	\$847			DEPTH: 26.0	26.0
												HEIGHT: 33.0
											SEAT WIDTH: 18.0	18.0
											SEAT DEPTH: 16.0	16.0
											SEAT HEIGHT: 18.5	18.5
											BACK WIDTH: 19.0	19.0
											BACK HEIGHT: 17.5	17.5
											COM: 0.7 YD	0.7 YD
											COL: N/A	N/A
											WEIGHT: 24.0 LB	27.0 LB

# Bella

## NESTING

Webpage



GSA SIN # 33721

### ARM OPTIONS

CODE	DESCRIPTION	PRICE
A12	Fixed Arm	+\$60

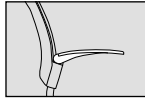

### FRAME COLORS

CODE	DESCRIPTION	PRICE
NSTB	Black	+\$0
NSTS	Silver	+\$0

### M1 MESH COLORS

CODE	DESCRIPTION	PRICE
M11	Black	+\$0
M12	Gray	+\$0
M13	Silver	+\$0

### PLASTIC COLORS

CODE	DESCRIPTION	PRICE
P01	Black Swan	+\$0
P05	White Whisper	+\$0
P11	Federal Blue	+\$0
P14	Dove Gray	+\$0
P15	Cloud Gray	+\$0
P16	Lagoon Blue	+\$0
P17	Apple Green	+\$0
P19	Latte	+\$0

### CASTER OPTIONS

CODE	DESCRIPTION	PRICE
C5	Carpet Casters	+\$0
C5S	Hard Floor and Carpet Casters	+\$75

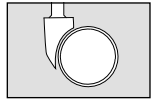
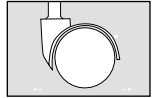

### NESTING FOOTPRINT

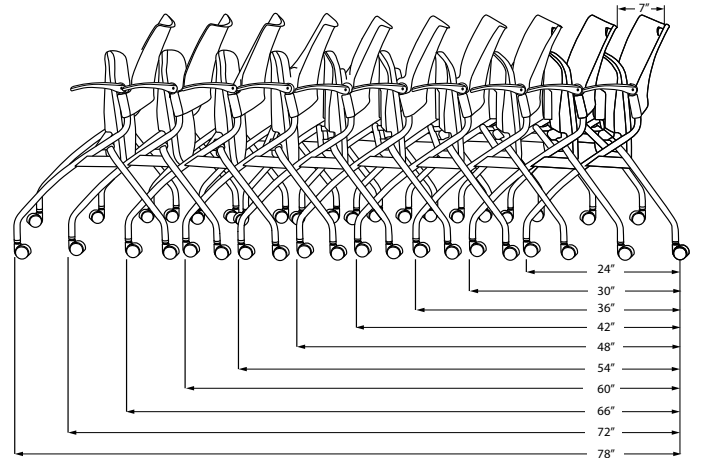

Careless stacking of chairs may scratch and damage frames. Due to the nature of vinyl upholstery, stacking may cause impressions on the seat. 9to5 Seating does not warrant the effects of the stacking on vinyl upholstery.

\*Black and Silver frame colors available as ExpressShip.



# Bella

NAME YOUR GAME, BELLA IS READY TO PLAY.

## 4 LEG

- Multi-purpose seating, including stacking, nesting, task and task stool model
- Perfect for collaborative, meeting, training and break room spaces
- Plastic, upholstered or mesh back options
- Warranted to 300 lbs.



Webpage

GSA SIN # 33721

### MODEL / CHAIR TYPE

### ARMS MATERIAL

### DIMENSIONS

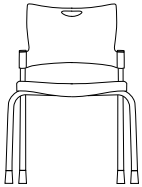

#### 1310 / FRM

Plastic Back - PB & Plastic Seat - PS Stacking

- Stacks 4 high on the floor
- Stacks 10 high on the optional stacking dolly
- Black non-marring nylon glides

	P									
A00	\$352									
A12	\$412									
TAB-A00	\$487									
TAB-12	\$527									

	ARMLESS	ARMS
WIDTH:	21.0	25.0
DEPTH:	26.0	26.0
HEIGHT:	33.0	33.0
SEAT WIDTH:	18.0	18.0
SEAT DEPTH:	16.0	16.0
SEAT HEIGHT:	18.0	18.0
BACK WIDTH:	19.0	19.0
BACK HEIGHT:	17.5	17.5
COM:	N/A	N/A
COL:	N/A	N/A
WEIGHT:	13.0 LB	15.0 LB

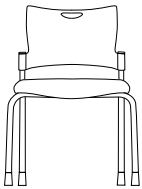

#### 1310 / FRM

Plastic Back - PB & Upholstered Seat - US Stacking

- Stacks 4 high on the floor
- Stacks 10 high on the optional stacking dolly
- Black non-marring nylon glides

	A	B/COM	C	D	E	F	G			
A00	\$412	\$437	\$467	\$507	\$552	\$602	\$662			
A12	\$472	\$497	\$527	\$567	\$612	\$662	\$722			
TAB-A00	\$547	\$572	\$602	\$642	\$687	\$737	\$797			
TAB-12	\$587	\$612	\$642	\$682	\$727	\$777	\$837			

	ARMLESS	ARMS
WIDTH:	21.0	25.0
DEPTH:	26.0	26.0
HEIGHT:	33.0	33.0
SEAT WIDTH:	18.0	18.0
SEAT DEPTH:	16.0	16.0
SEAT HEIGHT:	18.5	18.5
BACK WIDTH:	19.0	19.0
BACK HEIGHT:	17.5	17.5
COM:	0.8 YD	0.8 YD
COL:	N/A	N/A
WEIGHT:	17.0 LB	19.0 LB

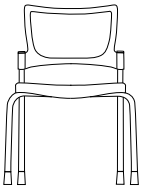

#### 1310 / FRM

Mesh Back - MB & Plastic Seat - PS Stacking

- Stacks 4 high on the floor
- Stacks 10 high on the optional stacking dolly
- Black non-marring nylon glides
- Three mesh colors in black plastic

	P									
A00	\$417									
A12	\$472									
TAB-A00	\$622									
TAB-12	\$702									

	ARMLESS	ARMS
WIDTH:	21.0	25.0
DEPTH:	26.0	26.0
HEIGHT:	33.0	33.0
SEAT WIDTH:	18.0	18.0
SEAT DEPTH:	16.0	16.0
SEAT HEIGHT:	18.0	18.0
BACK WIDTH:	19.0	19.0
BACK HEIGHT:	17.5	17.5
COM:	N/A	N/A
COL:	N/A	N/A
WEIGHT:	13.0 LB	15.0 LB

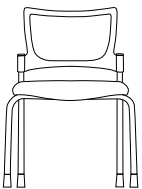

#### 1310 / FRM

Mesh Back - MB & Upholstered Seat - US Stacking

- Stacks 4 high on the floor
- Stacks 10 high on the optional stacking dolly
- Black non-marring nylon glides
- Three mesh colors in black plastic

	A	B/COM	C	D	E	F	G			
A00	\$477	\$502	\$532	\$572	\$617	\$667	\$727			
A12	\$537	\$562	\$592	\$632	\$677	\$727	\$787			
TAB-A00	\$612	\$637	\$667	\$707	\$752	\$802	\$862			
TAB-12	\$652	\$677	\$707	\$747	\$792	\$842	\$902			

	ARMLESS	ARMS
WIDTH:	21.0	25.0
DEPTH:	26.0	26.0
HEIGHT:	33.0	33.0
SEAT WIDTH:	18.0	18.0
SEAT DEPTH:	16.0	16.0
SEAT HEIGHT:	18.5	18.5
BACK WIDTH:	19.0	19.0
BACK HEIGHT:	17.5	17.5
COM:	0.8 YD	0.8 YD
COL:	N/A	N/A
WEIGHT:	17.0 LB	19.0 LB

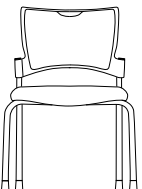

#### 1310 / FRM

Upholstered Back - UB & Upholstered Seat - US Stacking

- Stacks 4 high on the floor
- Stacks 10 high on the optional stacking dolly
- Black non-marring nylon glides

	A	B/COM	C	D	E	F	G			
A00	\$472	\$502	\$532	\$587	\$637	\$682	\$747			
A12	\$532	\$562	\$592	\$647	\$697	\$742	\$807			
TAB-A00	\$607	\$637	\$667	\$722	\$772	\$817	\$882			
TAB-12	\$647	\$677	\$707	\$762	\$812	\$857	\$922			

	ARMLESS	ARMS
WIDTH:	21.0	25.0
DEPTH:	26.0	26.0
HEIGHT:	33.0	33.0
SEAT WIDTH:	18.0	18.0
SEAT DEPTH:	16.0	16.0
SEAT HEIGHT:	18.5	18.5
BACK WIDTH:	19.0	19.0
BACK HEIGHT:	17.5	17.5
COM:	0.8 YD	0.8 YD
COL:	N/A	N/A
WEIGHT:	17.0 LB	20.0 LB

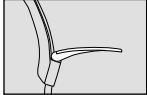
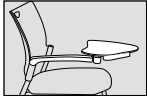
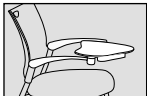

### ARM OPTIONS

CODE	DESCRIPTION	PRICE	
<b>A12</b>	Fixed Arm	+\$60	
<b>TAB-A00</b>	Right folding tablet with black supporting arm. <ul style="list-style-type: none"> <li>Tablet is black. No left arm. Frame color BF/SF. Not Stackable with Tablet.</li> <li>Dimensions: 15.5" x 11.25" x 0.25"</li> </ul>	+\$135	
<b>TAB-A12</b>	Right folding tablet with black supporting arm and A12 left arm. <ul style="list-style-type: none"> <li>Tablet is black. No left arm. Frame color BF/SF. Not Stackable with Tablet.</li> </ul>	+\$175	

### FRAME COLORS

CODE	DESCRIPTION	PRICE
<b>4LGB</b>	Black	+\$0
<b>4LGS</b>	Silver	+\$0

### PLASTIC COLORS\*

CODE	DESCRIPTION	PRICE
<b>P01</b>	Black Swan	+\$0
<b>P05</b>	White Whisper	+\$0
<b>P11</b>	Federal Blue	+\$0
<b>P14</b>	Dove Gray	+\$0
<b>P15</b>	Cloud Gray	+\$0
<b>P16</b>	Lagoon Blue	+\$0
<b>P17</b>	Apple Green	+\$0
<b>P19</b>	Latte	+\$0

(Back and Seat) \*Mesh back frame is P01 Black Swan.

### M1 MESH COLORS

CODE	DESCRIPTION	PRICE
<b>M11</b>	Black	+\$0
<b>M12</b>	Gray	+\$0
<b>M13</b>	Silver	+\$0

### CASTER OPTIONS

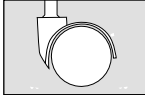
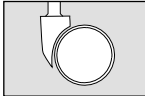
CODE	DESCRIPTION	PRICE	
<b>C5</b>	Carpet Casters	+\$45	
<b>C5S</b>	Hard Floor and Carpet Casters	+\$75	

### ADDITIONAL OPTIONS

CODE	DESCRIPTION	PRICE	
<b>G31B</b>	Tapered Plastic Glide <ul style="list-style-type: none"> <li>Black</li> </ul>	+\$0	
<b>G31G</b>	Tapered Plastic Glide <ul style="list-style-type: none"> <li>Gray</li> </ul>	+\$0	

### ACCESSORIES

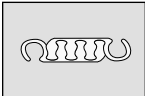
CODE	DESCRIPTION	PRICE	
<b>DL5</b>	Stacking Dolly <ul style="list-style-type: none"> <li>Stacks Chairs 10 High</li> </ul>	+\$399	
<b>GC1</b>	Ganging Clip <ul style="list-style-type: none"> <li>2 per Set</li> <li>Armless-to-Armless</li> </ul>	+\$30	
<b>GC2</b>	Ganging Clip <ul style="list-style-type: none"> <li>2 per Set</li> <li>Arm-to-Arm</li> </ul>	+\$30	

Careless stacking of chairs may scratch and damage frames. Due to the nature of vinyl upholstery, stacking may cause impressions on the seat. 9to5 Seating does not warrant the effects of the stacking on vinyl upholstery.

\*Black and Silver frame colors available as ExpressShip.



# Bella

NAME YOUR GAME, BELLA IS  
READY TO PLAY.

## TASK

- Multi-purpose seating, including stacking, nesting, task and task stool model
- Perfect for collaborative, meeting, training and break room spaces
- Plastic, upholstered or mesh back options
- Warranted to 300 lbs.

Webpage



GSA SIN # 33721

### MODEL / CHAIR TYPE / CONTROL    ARMS    MATERIAL    DIMENSIONS



#### 1310 / TSK / B2

Plastic Back - PB &  
Plastic Seat - PS  
Task

- 360° swivel
- Pneumatic cylinder height adjustment

	P									
A00	\$477									
A12	\$537									

WIDTH: 26.0  
DEPTH: 26.0  
HEIGHT: 32.5-37.5  
SEAT WIDTH: 18.0  
SEAT DEPTH: 16.0  
SEAT HEIGHT: 18.0-23.0  
BACK WIDTH: 19.0  
BACK HEIGHT: 17.5  
COM: N/A  
COL: N/A  
WEIGHT: 24.5 LB



#### 1310 / TSK / B2

Plastic Back - PB &  
Upholstered Seat - US  
Task

- 360° swivel
- Pneumatic cylinder height adjustment

	A	B/COM	C	D	E	F	G			
A00	\$537	\$562	\$592	\$632	\$677	\$727	\$787			
A12	\$597	\$622	\$652	\$692	\$737	\$787	\$847			

WIDTH: 26.0  
DEPTH: 26.0  
HEIGHT: 32.5-37.5  
SEAT WIDTH: 18.0  
SEAT DEPTH: 16.0  
SEAT HEIGHT: 18.0-23.0  
BACK WIDTH: 19.0  
BACK HEIGHT: 17.5  
COM: 0.8 YD  
COL: N/A  
WEIGHT: 26.5 LB



#### 1310 / TSK / B2

Mesh Back - MB &  
Plastic Seat - PS  
Task

- 360° swivel
- Pneumatic cylinder height adjustment
- Three mesh colors in black plastic

	P									
A00	\$542									
A12	\$602									

WIDTH: 26.0  
DEPTH: 26.0  
HEIGHT: 32.5-37.5  
SEAT WIDTH: 18.0  
SEAT DEPTH: 16.0  
SEAT HEIGHT: 18.0-23.0  
BACK WIDTH: 19.0  
BACK HEIGHT: 17.5  
COM: N/A  
COL: N/A  
WEIGHT: 24.5 LB



#### 1310 / TSK / B2

Mesh Back - MB &  
Upholstered Seat - US  
Task

- 360° swivel
- Pneumatic cylinder height adjustment
- Three mesh colors in black plastic

	A	B/COM	C	D	E	F	G			
A00	\$602	\$627	\$657	\$697	\$742	\$792	\$852			
A12	\$662	\$687	\$717	\$757	\$802	\$852	\$912			

WIDTH: 26.0  
DEPTH: 26.0  
HEIGHT: 32.5-37.5  
SEAT WIDTH: 18.0  
SEAT DEPTH: 16.0  
SEAT HEIGHT: 18.0-23.0  
BACK WIDTH: 19.0  
BACK HEIGHT: 17.5  
COM: 0.8 YD  
COL: N/A  
WEIGHT: 26.5 LB



#### 1310 / TSK / B2

Upholstered Back - UB  
& Upholstered Seat -  
US Task

- 360° swivel
- Pneumatic cylinder height adjustment

	A	B/COM	C	D	E	F	G			
A00	\$597	\$627	\$657	\$712	\$762	\$807	\$872			
A12	\$657	\$687	\$717	\$772	\$822	\$867	\$932			

WIDTH: 25.0  
DEPTH: 26.0  
HEIGHT: 32.5-37.5  
SEAT WIDTH: 18.0  
SEAT DEPTH: 16.0  
SEAT HEIGHT: 18.0-23.0  
BACK WIDTH: 19.0  
BACK HEIGHT: 17.5  
COM: 0.8 YD  
COL: N/A  
WEIGHT: 30.0 LB



### ARM OPTIONS

CODE	DESCRIPTION	PRICE
<b>A12</b>	Fixed Arm	+\$60

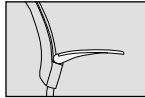

### FRAME COLORS

CODE	DESCRIPTION	PRICE
<b>TSKB</b>	Black	+\$0
<b>TSKS</b>	Silver	+\$0

### PLASTIC COLORS

CODE	DESCRIPTION	PRICE
<b>P01</b>	Black Swan	+\$0
<b>P05</b>	White Whisper	+\$0
<b>P11</b>	Federal Blue	+\$0
<b>P14</b>	Dove Gray	+\$0
<b>P15</b>	Cloud Gray	+\$0
<b>P16</b>	Lagoon Blue	+\$0
<b>P17</b>	Apple Green	+\$0
<b>P19</b>	Latte	+\$0

### M1 MESH COLORS

CODE	DESCRIPTION	PRICE
<b>M11</b>	Black	+\$0
<b>M12</b>	Gray	+\$0
<b>M13</b>	Silver	+\$0

### STOOL OPTIONS

CODE	DESCRIPTION	PRICE
<b>CY30B</b>	8" Stool • (Seat Height: 22"-30") • Use for work surfaces up to 36"	+\$125
<b>CY36B</b>	10" Stool • (Seat Height: 25"-36") • Use for work surfaces up to 42"	+\$125



### BASE OPTIONS

CODE	DESCRIPTION	PRICE
<b>BA11B</b>	27" Mid-Profile Nylon Base • Black	+\$0
<b>BA12B</b>	27" Mid-Profile Aluminum Base • Black	+\$110
<b>BA12P</b>	27" Mid-Profile Aluminum Base • Polished	+\$110
<b>BA12S</b>	27" Mid-Profile Aluminum Base • Silver	+\$110

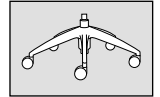
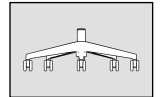

### CASTER OPTIONS

CODE	DESCRIPTION	PRICE
<b>C6</b>	Large Diameter Carpet Casters	+\$0
<b>C6S</b>	Large Diameter, Hard Floor and Carpet Casters	+\$35

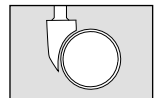
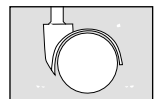



# Bella

NAME YOUR GAME, BELLA IS READY TO PLAY.

## TASK

- Multi-purpose seating, including stacking, nesting, task and task stool model
- Perfect for collaborative, meeting, training and break room spaces
- Plastic, upholstered or mesh back options
- Warranted to 300 lbs.

Webpage



GSA SIN # 33721

### MODEL / CHAIR TYPE / CONTROL    ARMS    MATERIAL    DIMENSIONS



#### 1310 / TSK / S3

Plastic Back - PB & Plastic Seat - PS Task

- 360° swivel
- Pneumatic cylinder height adjustment
- Upright tilt lock
- Center knob tension adjustment

	P									
A00	\$512									
A12	\$572									

WIDTH:	26.0
DEPTH:	26.0
HEIGHT:	32.5-37.5
SEAT WIDTH:	18.0
SEAT DEPTH:	16.0
SEAT HEIGHT:	18.0-23.0
BACK WIDTH:	19.0
BACK HEIGHT:	17.5
COM:	N/A
COL:	N/A
WEIGHT:	24.5 LB



#### 1310 / TSK / S3

Plastic Back - PB & Upholstered Seat - US Task

- 360° swivel
- Pneumatic cylinder height adjustment
- Upright tilt lock
- Center knob tension adjustment

	A	B/COM	C	D	E	F	G			
A00	\$572	\$597	\$627	\$667	\$712	\$762	\$822			
A12	\$632	\$657	\$687	\$727	\$772	\$822	\$882			

WIDTH:	26.0
DEPTH:	26.0
HEIGHT:	32.5-37.5
SEAT WIDTH:	18.0
SEAT DEPTH:	16.0
SEAT HEIGHT:	18.0-23.0
BACK WIDTH:	19.0
BACK HEIGHT:	17.5
COM:	0.8 YD
COL:	N/A
WEIGHT:	26.5 LB



#### 1310 / TSK / S3

Mesh Back - MB & Plastic Seat - PS Task

- 360° swivel
- Pneumatic cylinder height adjustment
- Three mesh colors in black plastic
- Upright tilt lock
- Center knob tension adjustment

	P									
A00	\$577									
A12	\$637									

WIDTH:	26.0
DEPTH:	26.0
HEIGHT:	32.5-37.5
SEAT WIDTH:	18.0
SEAT DEPTH:	16.0
SEAT HEIGHT:	18.0-23.0
BACK WIDTH:	19.0
BACK HEIGHT:	17.5
COM:	N/A
COL:	N/A
WEIGHT:	24.5 LB



#### 1310 / TSK / S3

Mesh Back - MB & Upholstered Seat - US Task

- 360° swivel
- Pneumatic cylinder height adjustment
- Three mesh colors in black plastic
- Upright tilt lock
- Center knob tension adjustment

	A	B/COM	C	D	E	F	G			
A00	\$637	\$662	\$692	\$732	\$777	\$827	\$887			
A12	\$697	\$722	\$752	\$792	\$837	\$887	\$947			

WIDTH:	26.0
DEPTH:	26.0
HEIGHT:	32.5-37.5
SEAT WIDTH:	18.0
SEAT DEPTH:	16.0
SEAT HEIGHT:	18.0-23.0
BACK WIDTH:	19.0
BACK HEIGHT:	17.5
COM:	0.8 YD
COL:	N/A
WEIGHT:	26.5 LB



#### 1310 / TSK / S3

Upholstered Back - UB & Upholstered Seat - US Task

- 360° swivel
- Pneumatic cylinder height adjustment
- Upright tilt lock
- Center knob tension adjustment

	A	B/COM	C	D	E	F	G			
A00	\$632	\$662	\$692	\$747	\$797	\$842	\$907			
A12	\$692	\$722	\$752	\$807	\$857	\$902	\$967			

WIDTH:	25.0
DEPTH:	26.0
HEIGHT:	32.5-37.5
SEAT WIDTH:	18.0
SEAT DEPTH:	16.0
SEAT HEIGHT:	18.0-23.0
BACK WIDTH:	19.0
BACK HEIGHT:	17.5
COM:	0.8 YD
COL:	N/A
WEIGHT:	30.0 LB



### ARM OPTIONS

CODE	DESCRIPTION	PRICE
<b>A12</b>	Fixed Arm	+\$60

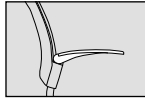

### FRAME COLORS

CODE	DESCRIPTION	PRICE
<b>TSKB</b>	Black	+\$0
<b>TSKS</b>	Silver	+\$0

### PLASTIC COLORS

CODE	DESCRIPTION	PRICE
<b>P01</b>	Black Swan	+\$0
<b>P05</b>	White Whisper	+\$0
<b>P11</b>	Federal Blue	+\$0
<b>P14</b>	Dove Gray	+\$0
<b>P15</b>	Cloud Gray	+\$0
<b>P16</b>	Lagoon Blue	+\$0
<b>P17</b>	Apple Green	+\$0
<b>P19</b>	Latte	+\$0

### M1 MESH COLORS

CODE	DESCRIPTION	PRICE
<b>M11</b>	Black	+\$0
<b>M12</b>	Gray	+\$0
<b>M13</b>	Silver	+\$0

### STOOL OPTIONS

CODE	DESCRIPTION	PRICE
<b>CY30B</b>	8" Stool • (Seat Height: 22"-30") • Use for work surfaces up to 36"	+\$125
<b>CY36B</b>	10" Stool • (Seat Height: 25"-36") • Use for work surfaces up to 42"	+\$125



### BASE OPTIONS

CODE	DESCRIPTION	PRICE
<b>BA11B</b>	27" Mid-Profile Nylon Base • Black	+\$0
<b>BA12B</b>	27" Mid-Profile Aluminum Base • Black	+\$110
<b>BA12P</b>	27" Mid-Profile Aluminum Base • Polished	+\$110
<b>BA12S</b>	27" Mid-Profile Aluminum Base • Silver	+\$110

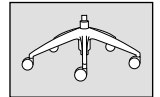
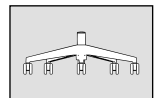

### CASTER OPTIONS

CODE	DESCRIPTION	PRICE
<b>C6</b>	Large Diameter Carpet Casters	+\$0
<b>C6S</b>	Large Diameter, Hard Floor and Carpet Casters	+\$35

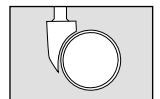
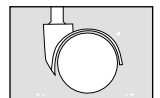



# Bristol

SEAMLESS INTEGRATION INTO  
YOUR OFFICE'S ARCHITECTURE

## MID-BACK

- Task, stool, conference and executive seating
- Ratchet back lumbar height adjustment
- Ballistic nylon optional
- Warranted to 300 lbs.

Webpage



GSA SIN # 33721

### MODEL / CONTROL

### ARMS MATERIAL

### DIMENSIONS

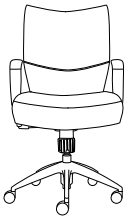

#### 2360 / S2

##### Mid-Back Swivel Tilt

- Upright lock
- Center knob tension adjustment
- 360° swivel
- Pneumatic cylinder height adjustment

	A	B/COM	C	D	E	F	G	L3/COL	L4	L5
A00	\$986	\$1036	\$1071	\$1116	\$1166	\$1231	\$1311	\$1221	\$1286	\$1486
A8B/S	\$1091	\$1141	\$1176	\$1221	\$1271	\$1336	\$1416	\$1326	\$1391	\$1591
A9B/S	\$1101	\$1151	\$1186	\$1231	\$1281	\$1346	\$1426	\$1336	\$1401	\$1601
A10	\$1096	\$1146	\$1181	\$1226	\$1276	\$1341	\$1421	\$1331	\$1396	\$1596
A19	\$1221	\$1271	\$1306	\$1351	\$1401	\$1466	\$1546	\$1456	\$1521	\$1721
A36	\$1111	\$1161	\$1196	\$1241	\$1291	\$1356	\$1436	\$1346	\$1411	\$1611
A37	\$1126	\$1176	\$1211	\$1256	\$1306	\$1371	\$1451	\$1361	\$1426	\$1626

WIDTH:	25.0
DEPTH:	26.0
HEIGHT:	37.5-45.5
SEAT WIDTH:	20.0
SEAT DEPTH:	19.0
SEAT HEIGHT:	16.5-21.0
SEAT HEIGHT W/ SEAT SLIDER:	18-22.5
BACK WIDTH:	20.0
BACK HEIGHT:	19.0-21.5
COM:	1.4 YD
COL:	33.0 SQ FT
WEIGHT:	30.0 LB

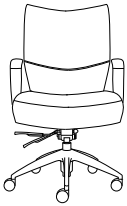

#### 2360 / P1

##### Mid-Back Posture Back

- Ratchet back lumbar adjustment
- Infinite tilt lock
- 360° swivel
- Center knob tension adjustment

	A	B/COM	C	D	E	F	G	L3/COL	L4	L5
A00	\$1026	\$1076	\$1111	\$1156	\$1206	\$1271	\$1351	\$1261	\$1326	\$1526
A8B/S	\$1131	\$1181	\$1216	\$1261	\$1311	\$1376	\$1456	\$1366	\$1431	\$1631
A9B/S	\$1141	\$1191	\$1226	\$1271	\$1321	\$1386	\$1466	\$1376	\$1441	\$1641
A10	\$1136	\$1186	\$1221	\$1266	\$1316	\$1381	\$1461	\$1371	\$1436	\$1636
A19	\$1261	\$1311	\$1346	\$1391	\$1441	\$1506	\$1586	\$1496	\$1561	\$1761
A36	\$1151	\$1201	\$1236	\$1281	\$1331	\$1396	\$1476	\$1386	\$1451	\$1651
A37	\$1166	\$1216	\$1251	\$1296	\$1346	\$1411	\$1491	\$1401	\$1466	\$1666

WIDTH:	25.0
DEPTH:	26.0
HEIGHT:	38.5-45.5
SEAT WIDTH:	20.0
SEAT DEPTH:	19.0
SEAT HEIGHT:	17.5-21.0
SEAT HEIGHT W/ SEAT SLIDER:	19-23.5
BACK WIDTH:	20.0
BACK HEIGHT:	19.0-23.5
COM:	1.4 YD
COL:	33.0 SQ FT
WEIGHT:	35.0 LB



#### 2360 / R1

##### Mid-Back Rocking Tilt

- Infinite back angle adjustment
- Infinite tilt lock
- Center knob tension adjustment
- 360° swivel
- Pneumatic cylinder height adjustment

	A	B/COM	C	D	E	F	G	L3/COL	L4	L5
A00	\$1036	\$1086	\$1121	\$1166	\$1216	\$1281	\$1361	\$1271	\$1336	\$1536
A8B/S	\$1141	\$1191	\$1226	\$1271	\$1321	\$1386	\$1466	\$1376	\$1441	\$1641
A9B/S	\$1151	\$1201	\$1236	\$1281	\$1331	\$1396	\$1476	\$1386	\$1451	\$1651
A10	\$1146	\$1196	\$1231	\$1276	\$1326	\$1391	\$1471	\$1381	\$1446	\$1646
A19	\$1271	\$1321	\$1356	\$1401	\$1451	\$1516	\$1596	\$1506	\$1571	\$1771
A36	\$1161	\$1211	\$1246	\$1291	\$1341	\$1406	\$1486	\$1396	\$1461	\$1661
A37	\$1176	\$1226	\$1261	\$1306	\$1356	\$1421	\$1501	\$1411	\$1476	\$1676

WIDTH:	25.0
DEPTH:	26.0
HEIGHT:	38.5-45.5
SEAT WIDTH:	20.0
SEAT DEPTH:	19.0
SEAT HEIGHT:	17.5-22.5
SEAT HEIGHT W/ SEAT SLIDER:	19.0-23.5
BACK WIDTH:	20.0
BACK HEIGHT:	19.0-21.5
COM:	1.4 YD
COL:	33.0 SQ FT
WEIGHT:	35.0 LB



#### 2360 / Y2

##### Mid-Back Heavy Duty Synchro Tilt

- 4-position tilt lock
- Side knob tension adjustment
- 2:1 back-to-seat tilt ratio
- 360° swivel
- Pneumatic cylinder height adjustment

	A	B/COM	C	D	E	F	G	L3/COL	L4	L5
A00	\$1066	\$1116	\$1151	\$1196	\$1246	\$1311	\$1391	\$1301	\$1366	\$1566
A8B/S	\$1171	\$1221	\$1256	\$1301	\$1351	\$1416	\$1496	\$1406	\$1471	\$1671
A9B/S	\$1181	\$1231	\$1266	\$1311	\$1361	\$1426	\$1506	\$1416	\$1481	\$1681
A10	\$1176	\$1226	\$1261	\$1306	\$1356	\$1421	\$1501	\$1411	\$1476	\$1676
A19	\$1301	\$1351	\$1386	\$1431	\$1481	\$1546	\$1626	\$1536	\$1601	\$1801
A36	\$1191	\$1241	\$1276	\$1321	\$1371	\$1436	\$1516	\$1426	\$1491	\$1691
A37	\$1206	\$1256	\$1291	\$1336	\$1386	\$1451	\$1531	\$1441	\$1506	\$1706

WIDTH:	25.0
DEPTH:	26.0
HEIGHT:	38.5-45.5
SEAT WIDTH:	20.0
SEAT DEPTH:	19.0
SEAT HEIGHT:	17.5-22.0
SEAT HEIGHT W/ SEAT SLIDER:	19.0-23.5
BACK WIDTH:	20.0
BACK HEIGHT:	19.0-21.5
COM:	1.4 YD
COL:	33.0 SQ FT
WEIGHT:	37.0 LB



#### 2360 / M1

##### Mid-Back Multi-Function

- Infinite back angle adjustment
- 6° forward tilt
- Center knob tension adjustment
- 360° swivel
- Pneumatic cylinder height adjustment

	A	B/COM	C	D	E	F	G	L3/COL	L4	L5
A00	\$1086	\$1136	\$1171	\$1216	\$1266	\$1331	\$1411	\$1321	\$1386	\$1586
A8B/S	\$1191	\$1241	\$1276	\$1321	\$1371	\$1436	\$1516	\$1426	\$1491	\$1691
A9B/S	\$1201	\$1251	\$1286	\$1331	\$1381	\$1446	\$1526	\$1436	\$1501	\$1701
A10	\$1196	\$1246	\$1281	\$1326	\$1376	\$1441	\$1521	\$1431	\$1496	\$1696
A19	\$1321	\$1371	\$1406	\$1451	\$1501	\$1566	\$1646	\$1556	\$1621	\$1821
A36	\$1211	\$1261	\$1296	\$1341	\$1391	\$1456	\$1536	\$1446	\$1511	\$1711
A37	\$1226	\$1276	\$1311	\$1356	\$1406	\$1471	\$1551	\$1461	\$1526	\$1726

WIDTH:	25.0
DEPTH:	26.0
HEIGHT:	38.5-45.5
SEAT WIDTH:	20.0
SEAT DEPTH:	19.0
SEAT HEIGHT:	17.5-22.0
SEAT HEIGHT W/ SEAT SLIDER:	19.0-23.5
BACK WIDTH:	20.0
BACK HEIGHT:	19.0-21.5
COM:	1.4 YD
COL:	33.0 SQ FT
WEIGHT:	39.0 LB

# Bristol







## MID-BACK

Webpage

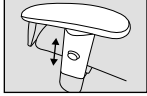
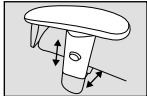

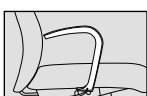
GSA SIN # 33721



### ARM OPTIONS

CODE	DESCRIPTION	PRICE	
<b>A8B</b>	Height Adjustable Arm • Black	+\$105	
<b>A8S</b>	Height Adjustable Arm • Silver	+\$105	
<b>A9B</b>	Height/Width Adjustable Arm • Black	+\$115	
<b>A9S</b>	Height/Width Adjustable Arm • Silver	+\$115	
<b>A10</b>	Soft Touch C-Shaped Arm	+\$110	
<b>A19</b>	Polished Aluminum C-Shape Arm	+\$235	
<b>A36</b>	Height Adjustable Pivot/Slide Arm	+\$125	
<b>A37</b>	Height/Width Adjustable Pivot/Slide Arm	+\$140	

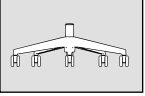
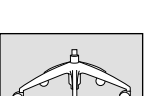

### STOOL OPTIONS

CODE	DESCRIPTION	PRICE	
<b>CY30</b>	8" Stool • Seat Height: 22"-30" • Use for work surfaces up to 36"	+\$125	
<b>CY36</b>	10" Stool • Seat Height: 25"-36" • Use for work surfaces up to 42"	+\$125	

### BASE OPTIONS

CODE	DESCRIPTION	PRICE	
<b>BA11B</b>	27" Mid-Profile Nylon Base • Black	+\$0	
<b>BA12B</b>	27" Mid-Profile Aluminum Base • Black	+\$110	
<b>BA12P</b>	27" Mid-Profile Aluminum Base • Polished	+\$110	
<b>BA12S</b>	27" Mid-Profile Aluminum Base • Silver	+\$110	

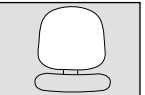
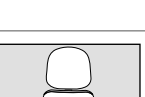
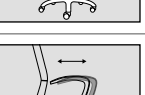
### ADDITIONAL OPTIONS

CODE	DESCRIPTION	PRICE	
<b>BN1</b>	Upholstered Outer Back in Black Ballistic Nylon • Grade A Only	+\$35	
<b>BN2</b>	Upholstered Outer Back in Black Ballistic Nylon • Grade B and Up	+\$0	
<b>HD</b>	Heavy Duty Multi-Shift • Upgrade to 350 lb. • Includes BA12 High Profile Aluminum Base (Y2 Control only)	+\$125	
<b>SS</b>	Seat Slider 2.5" • Side Paddle Activated • Factory Installed • Seat slider not available with mid-back stools	+\$60	

### CASTER OPTIONS

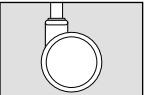
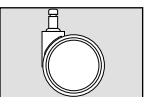
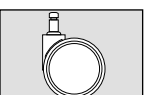
CODE	DESCRIPTION	PRICE	
<b>C6</b>	Large Diameter Carpet Casters	+\$0	
<b>C6S</b>	Large Diameter Hard Floor and Carpet Casters	+\$35	
<b>C7</b>	Chrome-Accented Hard Floor and Carpet Casters	+\$35	



# Bristol

SEAMLESS INTEGRATION INTO  
YOUR OFFICE'S ARCHITECTURE

## HIGH-BACK

- Task, stool, conference and executive seating
- Ratchet back lumbar height adjustment
- Ballistic nylon optional
- Warranted to 300 lbs.

Webpage



GSA SIN # 33721

### MODEL / CONTROL

### ARMS MATERIAL

### DIMENSIONS



#### 2380 / S2

##### High-Back Swivel Tilt

- Upright lock
- Center knob tension adjustment
- 360° swivel
- Pneumatic cylinder height adjustment

	A	B/COM	C	D	E	F	G	L3/COL	L4	L5
A00	\$1036	\$1091	\$1131	\$1176	\$1241	\$1296	\$1386	\$1291	\$1346	\$1561
A8B/S	\$1141	\$1196	\$1236	\$1281	\$1346	\$1401	\$1491	\$1396	\$1451	\$1666
A9B/S	\$1151	\$1206	\$1246	\$1291	\$1356	\$1411	\$1501	\$1406	\$1461	\$1676
A10	\$1146	\$1201	\$1241	\$1286	\$1351	\$1406	\$1496	\$1401	\$1456	\$1671
A19	\$1271	\$1326	\$1366	\$1411	\$1476	\$1531	\$1621	\$1526	\$1581	\$1796
A36	\$1161	\$1216	\$1256	\$1301	\$1366	\$1421	\$1511	\$1416	\$1471	\$1686
A37	\$1176	\$1231	\$1271	\$1316	\$1381	\$1436	\$1526	\$1431	\$1486	\$1701

WIDTH: 25.0  
DEPTH: 26.0  
HEIGHT: 40.5-48.5  
SEAT WIDTH: 20.0  
SEAT DEPTH: 19.0  
SEAT HEIGHT: 16.5-21.0  
SEAT HEIGHT W/  
SEAT SLIDER: 18-22.5  
BACK WIDTH: 20.0  
BACK HEIGHT: 23.0-25.5  
COM: 1.5 YD  
COL: 35.0 SQ FT  
WEIGHT: 31.0 LB



#### 2380 / R1

##### High-Back Rocking Tilt

- Infinite back angle adjustment
- Infinite tilt lock
- Center knob tension adjustment
- 360° swivel
- Pneumatic cylinder height adjustment

	A	B/COM	C	D	E	F	G	L3/COL	L4	L5
A00	\$1086	\$1141	\$1181	\$1226	\$1291	\$1346	\$1436	\$1341	\$1396	\$1611
A8B/S	\$1191	\$1246	\$1286	\$1331	\$1396	\$1451	\$1541	\$1446	\$1501	\$1716
A9B/S	\$1201	\$1256	\$1296	\$1341	\$1406	\$1461	\$1551	\$1456	\$1511	\$1726
A10	\$1196	\$1251	\$1291	\$1336	\$1401	\$1456	\$1546	\$1451	\$1506	\$1721
A19	\$1321	\$1376	\$1416	\$1461	\$1526	\$1581	\$1671	\$1576	\$1631	\$1846
A36	\$1211	\$1266	\$1306	\$1351	\$1416	\$1471	\$1561	\$1466	\$1521	\$1736
A37	\$1226	\$1281	\$1321	\$1366	\$1431	\$1486	\$1576	\$1481	\$1536	\$1751

WIDTH: 25.0  
DEPTH: 26.0  
HEIGHT: 41.5-48.5  
SEAT WIDTH: 20.0  
SEAT DEPTH: 19.0  
SEAT HEIGHT: 18.0  
SEAT HEIGHT W/  
SEAT SLIDER: 18.0-22.5  
BACK WIDTH: 20.0  
BACK HEIGHT: 23.0-25.5  
COM: 1.5 YD  
COL: 35.0 SQ FT  
WEIGHT: 36.0 LB



#### 2380 / Y2

##### High-Back Heavy Duty Synchro Tilt

- 4-position tilt lock
- Side knob tension adjustment
- 2:1 back-to-seat tilt ratio
- 360° swivel
- Pneumatic cylinder height adjustment

	A	B/COM	C	D	E	F	G	L3/COL	L4	L5
A00	\$1116	\$1171	\$1211	\$1256	\$1321	\$1376	\$1466	\$1371	\$1426	\$1641
A8B/S	\$1221	\$1276	\$1316	\$1361	\$1426	\$1481	\$1571	\$1476	\$1531	\$1746
A9B/S	\$1231	\$1286	\$1326	\$1371	\$1436	\$1491	\$1581	\$1486	\$1541	\$1756
A10	\$1226	\$1281	\$1321	\$1366	\$1431	\$1486	\$1576	\$1481	\$1536	\$1751
A19	\$1351	\$1406	\$1446	\$1491	\$1556	\$1611	\$1701	\$1606	\$1661	\$1876
A36	\$1241	\$1296	\$1336	\$1381	\$1446	\$1501	\$1591	\$1496	\$1551	\$1766
A37	\$1256	\$1311	\$1351	\$1396	\$1461	\$1516	\$1606	\$1511	\$1566	\$1781

WIDTH: 25.0  
DEPTH: 26.0  
HEIGHT: 41.5-48.5  
SEAT WIDTH: 20.0  
SEAT DEPTH: 19.0  
SEAT HEIGHT: 17.5-22.0  
SEAT HEIGHT W/  
SEAT SLIDER: 18.0-22.5  
BACK WIDTH: 20.0  
BACK HEIGHT: 23.0-25.5  
COM: 1.5 YD  
COL: 35.0 SQ FT  
WEIGHT: 38.0 LB



#### 2380 / M1

##### High-Back Multi-Function

- Infinite back angle adjustment
- 6° forward tilt
- Center knob tension adjustment
- 360° swivel
- Pneumatic cylinder height adjustment

	A	B/COM	C	D	E	F	G	L3/COL	L4	L5
A00	\$1136	\$1191	\$1231	\$1276	\$1341	\$1396	\$1486	\$1391	\$1446	\$1661
A8B/S	\$1241	\$1296	\$1336	\$1381	\$1446	\$1501	\$1591	\$1496	\$1551	\$1766
A9B/S	\$1251	\$1306	\$1346	\$1391	\$1456	\$1511	\$1601	\$1506	\$1561	\$1776
A10	\$1246	\$1301	\$1341	\$1386	\$1451	\$1506	\$1596	\$1501	\$1556	\$1771
A19	\$1371	\$1426	\$1466	\$1511	\$1576	\$1631	\$1721	\$1626	\$1681	\$1896
A36	\$1261	\$1316	\$1356	\$1401	\$1466	\$1521	\$1611	\$1516	\$1571	\$1786
A37	\$1276	\$1331	\$1371	\$1416	\$1481	\$1536	\$1626	\$1531	\$1586	\$1801

WIDTH: 25.0  
DEPTH: 26.0  
HEIGHT: 41.5-48.5  
SEAT WIDTH: 20.0  
SEAT DEPTH: 19.0  
SEAT HEIGHT: 17.5-22.0  
SEAT HEIGHT W/  
SEAT SLIDER: 18.0-22.5  
BACK WIDTH: 20.0  
BACK HEIGHT: 23.0-25.5  
COM: 1.5 YD  
COL: 35.0 SQ FT  
WEIGHT: 40.0 LB

# Bristol







## HIGH-BACK

Webpage

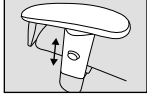
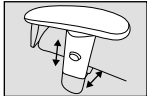

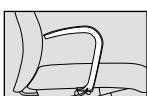
GSA SIN # 33721



### ARM OPTIONS

CODE	DESCRIPTION	PRICE	
<b>A8B</b>	Height Adjustable Arm • Black	+\$105	
<b>A8S</b>	Height Adjustable Arm • Silver	+\$105	
<b>A9B</b>	Height/Width Adjustable Arm • Black	+\$115	
<b>A9S</b>	Height/Width Adjustable Arm • Silver	+\$115	
<b>A10</b>	Soft Touch C-Shaped Arm	+\$110	
<b>A19</b>	Polished Aluminum C-Shape Arm	+\$235	
<b>A36</b>	Height Adjustable Pivot/Slide Arm	+\$125	
<b>A37</b>	Height/Width Adjustable Pivot/Slide Arm	+\$140	

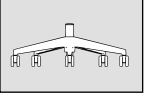
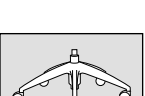

### STOOL OPTIONS

CODE	DESCRIPTION	PRICE	
<b>CY30</b>	8" Stool • Seat Height: 22"-30" • Use for work surfaces up to 36"	+\$125	
<b>CY36</b>	10" Stool • Seat Height: 25"-36" • Use for work surfaces up to 42"	+\$125	

### BASE OPTIONS

CODE	DESCRIPTION	PRICE	
<b>BA11B</b>	27" Mid-Profile Nylon Base • Black	+\$0	
<b>BA12B</b>	27" Mid-Profile Aluminum Base • Black	+\$110	
<b>BA12P</b>	27" Mid-Profile Aluminum Base • Polished	+\$110	
<b>BA12S</b>	27" Mid-Profile Aluminum Base • Silver	+\$110	

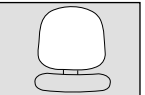
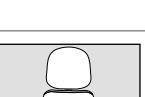
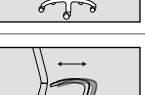
### ADDITIONAL OPTIONS

CODE	DESCRIPTION	PRICE	
<b>BN1</b>	Upholstered Outer Back in Black Ballistic Nylon • Grade A Only	+\$35	
<b>BN2</b>	Upholstered Outer Back in Black Ballistic Nylon • Grade B and Up	+\$0	
<b>HD</b>	Heavy Duty Multi-Shift • Upgrade to 350 lb. • Includes BA12 High Profile Aluminum Base (Y2 Control only)	+\$125	
<b>SS</b>	Seat Slider 2.5" • Side Paddle Activated • Factory Installed • Seat slider not available with mid-back stools	+\$60	

### CASTER OPTIONS

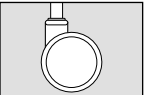
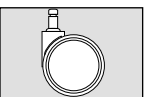
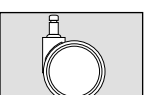
CODE	DESCRIPTION	PRICE	
<b>C6</b>	Large Diameter Carpet Casters	+\$0	
<b>C6S</b>	Large Diameter Hard Floor and Carpet Casters	+\$35	
<b>C7</b>	Chrome-Accented Hard Floor and Carpet Casters	+\$35	



# Cavo

SIMPLY SMART DESIGN.  
ANYWHERE.

## 4 LEG

- Multipurpose seating including stacking, side, stools and bariatric
- Modern, elegant and simple design
- All plastic, upholstered seat or fully upholstered
- Wall-saver frame design
- Warranted to 350 lbs.

Webpage



GSA SIN # 33721 PENDING

### MODEL / CHAIR TYPE

### ARMS MATERIAL

### DIMENSIONS

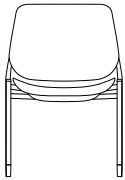

#### 1910 / FRM

Plastic Back - PB &  
Plastic Seat - PS  
Stacking

- Stacks 4 high on the floor
- Stacks 10 high on the optional dolly
- Wall-saver frame
- Non-marring floor glides

	P											
A00	\$398											
A55	\$458											

	ARMLESS	ARMS
WIDTH:	22.0	26.0
DEPTH:	25.0	25.0
HEIGHT:	35.0	35.0
SEAT WIDTH:	18.5	18.5
SEAT DEPTH:	17.7	17.7
SEAT HEIGHT:	17.7	17.7
BACK WIDTH:	20.0	20.0
BACK HEIGHT:	17.0	17.0
COM:	N/A	N/A
COL:	N/A	N/A
WEIGHT:	19.5 LB	21.5 LB

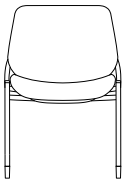

#### 1910 / FRM

Plastic Back - PB &  
Upholstered Seat - US  
Stacking

- Stacks 4 high on the floor
- Stacks 10 high on the optional dolly
- Wall-saver frame
- Non-marring floor glides

	A	B/COM	C	D	E	F	G	L3/COL	L4	L5
A00	\$438	\$463	\$491	\$525	\$583	\$638	\$671	\$628	\$573	\$603
A55	\$498	\$523	\$551	\$585	\$643	\$698	\$731	\$688	\$633	\$663

	ARMLESS	ARMS
WIDTH:	22.0	26.0
DEPTH:	25.0	25.0
HEIGHT:	35.0	35.0
SEAT WIDTH:	18.5	18.5
SEAT DEPTH:	17.7	17.7
SEAT HEIGHT:	18.5	18.5
BACK WIDTH:	20.0	20.5
BACK HEIGHT:	17.0	17.0
COM:	0.8 YD	0.8 YD
COL:	7.65 SQ FT	7.65 SQ FT
WEIGHT:	23.0 LB	25.0 LB

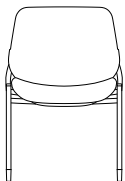

#### 1910 / FRM

Upholstered Back - UB  
& Upholstered Seat - US  
Stacking

- Stacks 4 high on the floor
- Stacks 10 high on the optional dolly
- Wall-saver frame
- Non-marring floor glides

	A	B/COM	C	D	E	F	G	L3/COL	L4	L5
A00	\$493	\$533	\$568	\$628	\$688	\$773	\$828	\$773	\$823	\$943
A55	\$553	\$593	\$628	\$688	\$748	\$833	\$888	\$833	\$883	\$1,003

	ARMLESS	ARMS
WIDTH:	22.0	26.0
DEPTH:	25.0	25.0
HEIGHT:	35.0	35.0
SEAT WIDTH:	18.5	18.5
SEAT DEPTH:	17.7	17.7
SEAT HEIGHT:	18.5	18.5
BACK WIDTH:	20.0	20.0
BACK HEIGHT:	17.0	17.0
COM:	1.6 YD	1.6 YD
COL:	15.1 SQ FT	15.1 SQ FT
WEIGHT:	26.5 LB	29.0 LB



### ARM OPTIONS

CODE	DESCRIPTION	PRICE
<b>A55B</b>	Soft Touch Polyurethane Arm • Black	+\$60
<b>A55G</b>	Soft Touch Polyurethane Arm • Gray	+\$60

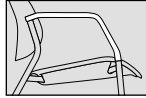

### FRAME COLORS

CODE	DESCRIPTION	PRICE
<b>4LGB</b>	Black	+\$0
<b>4LGS</b>	Silver	+\$0

Back cosmetic cover color matches frame color

### PLASTIC COLORS

CODE	DESCRIPTION	PRICE
<b>P01</b>	Black Swan	+\$0
<b>P05</b>	White Whisper	+\$0
<b>P11</b>	Federal Blue	+\$0
<b>P12</b>	Crimson Red	+\$0
<b>P13</b>	Lemon Yellow	+\$0
<b>P14</b>	Dove Gray	+\$0
<b>P15</b>	Cloud Gray	+\$0
<b>P16</b>	Lagoon Blue	+\$0
<b>P17</b>	Apple Green	+\$0
<b>P18</b>	Tangerine Orange	+\$0
<b>P19</b>	Latte	+\$0
<b>P20</b>	Azure Blue	+\$0

### CASTER OPTIONS

CODE	DESCRIPTION	PRICE
<b>C12S</b>	Hard Floor and Carpet Casters	+\$45

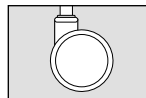

Add casters to any 4 leg model

### STOOL OPTIONS

CODE	DESCRIPTION	PRICE
<b>ST24B</b>	24" Counter Stool • Use for work surfaces up to 36" high • Black	+\$130
<b>ST24S</b>	24" Counter Stool • Use for work surfaces up to 36" high • Silver	+\$130
<b>ST30B</b>	30" Bar Stool • Use for work surfaces up to 42" high • Black	+\$150
<b>ST30S</b>	30" Bar Stool • Use for work surfaces up to 42" high • Silver	+\$150



### ADDITIONAL OPTIONS

CODE	DESCRIPTION	PRICE
<b>G21B</b>	Tapered Plastic Glide • Black	+\$0
<b>G21G</b>	Tapered Plastic Glide • Gray	+\$0
<b>G21BN</b>	Swivel Nylon Glide • Black Nylon	+\$20
<b>G21GN</b>	Swivel Nylon Glide • Gray Nylon	+\$20
<b>G21BS</b>	Swivel Steel Glide • Black Steel	+\$20
<b>G21GS</b>	Swivel Steel Glide • Gray Steel	+\$20
<b>G21BF</b>	Swivel Felt Glide • Black Felt	+\$20
<b>G21GF</b>	Swivel Felt Glide • Gray Felt	+\$20

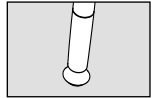
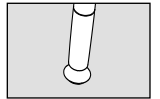
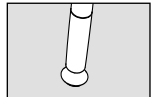
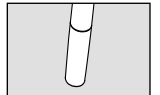

### ACCESSORIES

CODE	DESCRIPTION	PRICE
<b>GC9</b>	Ganging Clip • 2 per set, for Sled models • Arm-to-Arm and Armless-to-Armless	+\$30
<b>DL5</b>	Stacking Dolly • Stacks up to 8 High - 4-Leg Models • Stacks up to 20 High - Sled Models	+\$399

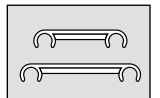



# Cavo

SIMPLY SMART DESIGN.  
ANYWHERE.

## BARIATRIC

- Multipurpose seating including stacking, side, stools and bariatric
- Modern, elegant and simple design
- All plastic, upholstered seat or fully upholstered
- Wall-saver frame design
- Warranted to 750 lbs.



Webpage

GSA SIN # 33721 PENDING

### MODEL / CHAIR TYPE

### ARMS MATERIAL

### DIMENSIONS

MODEL / CHAIR TYPE	ARMS	MATERIAL							DIMENSIONS		
		A	B/COM	C	D	E	F	G			
 <p><b>1912 / FRM</b> Upholstered Back - UB &amp; Upholstered Seat - US Stacking</p> <ul style="list-style-type: none"> <li>• Steel reinforced seat and back</li> <li>• 30" wide seat</li> <li>• Does not stack</li> <li>• Warranted to 750 lbs.</li> </ul>	A55	\$999	\$1,069	\$1,114	\$1,184	\$1,264	\$1,354	\$1,454			

WIDTH: 36.0  
DEPTH: 25.5  
HEIGHT: 34.0  
SEAT WIDTH: 29.5  
SEAT DEPTH: 17.7  
SEAT HEIGHT: 18.0  
BACK WIDTH: 30.0  
BACK HEIGHT: 17.0  
COM: 2.8 YD  
COL: N/A  
WEIGHT: 32.0 LB

# Cavo

## BARIATRIC

Webpage



PENDING

### ARM OPTIONS

CODE	DESCRIPTION	PRICE
<b>A55B</b>	Soft Touch Polyurethane Arm • Black	+\$0
<b>A55G</b>	Soft Touch Polyurethane Arm • Gray	+\$0

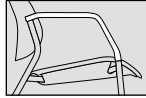

### FRAME COLORS

CODE	DESCRIPTION	PRICE
<b>4LGB</b>	Black	+\$0
<b>4LGS</b>	Silver	+\$0

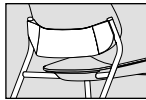

Back cosmetic cover color matches frame color

### ADDITIONAL OPTIONS

CODE	DESCRIPTION	PRICE
<b>G20N</b>	Tapered Plastic Glide	+\$0
<b>G20S</b>	Swivel Steel Glide	+\$20

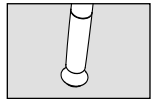
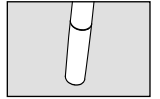

### ACCESSORIES

CODE	DESCRIPTION	PRICE
<b>GC9</b>	Ganging Clip • 2 per set, for Sled models • Arm-to-Arm	+\$30

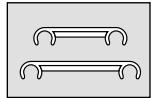



# Clary

WORKS WELL WITH OTHERS

## GUEST

- Side and guest seating
- Mesh or upholstered back options
- Wall-saver frame
- Warranted to 300 lbs.

Webpage



GSA SIN # 33721

### MODEL / CHAIR TYPE

### ARMS MATERIAL

### DIMENSIONS

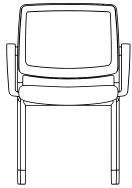

#### 1510 / FRM

#### Mesh Back - MB & Upholstered Seat - US

- Armless or fixed arms
- Stacks armless 4 on the floor and 6 on a dolly
- Stacks armed 4 on the floor and 5 on a dolly
- Arms and glides coordinate with the frame color

	A	B/COM	C	D	E	F	G	L/3 COL	L4
A00	\$458	\$486	\$513	\$543	\$573	\$618	\$658	\$618	\$668
A49B/G	\$518	\$546	\$573	\$603	\$633	\$678	\$718	\$678	\$728

	ARMLESS	ARMS
WIDTH:	19.0	22.5
DEPTH:	23.5	23.5
HEIGHT:	34.0	34.0
SEAT WIDTH:	18.5	18.5
SEAT DEPTH:	17.0	17.0
SEAT HEIGHT:	18.5	18.5
BACK WIDTH:	19.5	19.5
BACK HEIGHT:	16.0	16.0
COM:	1.0 YD	1.0 YD
COL:	13 SQ FT	13 SQ FT
WEIGHT:	15.5 LB	17.5 LB

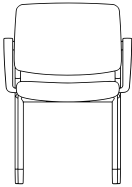

#### 1510 / FRM

#### Upholstered Back - UP & Upholstered Seat - US

- Armless or fixed arms
- Stacks armless 4 on the floor and 6 on a dolly
- Stacks armed 4 on the floor and 5 on a dolly
- Arms and glides coordinate with the frame color

	A	B/COM	C	D	E	F	G	L/3 COL	L4
A00	\$478	\$506	\$533	\$563	\$593	\$638	\$678	\$638	\$688
A49B/G	\$538	\$566	\$593	\$623	\$653	\$698	\$738	\$698	\$748

	ARMLESS	ARMS
WIDTH:	19.0	22.5
DEPTH:	23.5	23.5
HEIGHT:	34.0	34.0
SEAT WIDTH:	18.5	18.5
SEAT DEPTH:	17.0	17.0
SEAT HEIGHT:	18.5	18.5
BACK WIDTH:	19.5	19.5
BACK HEIGHT:	16.0	16.0
COM:	1.0 YD	1.0 YD
COL:	14 SQ FT	14 SQ FT
WEIGHT:	18.0 LB	20.0 LB

# Clary

## GUEST



GSA SIN # 33721

### ARM OPTIONS

CODE	DESCRIPTION	PRICE
<b>A49B</b>	Nylon Fixed Arm • Black	+\$60
<b>A49G</b>	Nylon Fixed Arm • Gray	+\$60

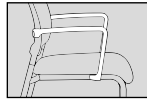

### FRAME COLORS

CODE	DESCRIPTION	PRICE
<b>4LGB</b>	Black	+\$0
<b>4LGS</b>	Silver	+\$0

### PLASTIC COLORS

CODE	DESCRIPTION	PRICE
<b>PBK</b>	Black	+\$0
<b>PGG</b>	Graphite Gray	+\$0

### MESH COLORS

CODE	DESCRIPTION	PRICE	CODE	DESCRIPTION	PRICE
<b>M11</b>	Black, M1	+\$0	<b>M32</b>	Slate, M3	+\$0
<b>M12</b>	Gray, M1	+\$0	<b>M33</b>	Snow, M3	+\$0
<b>M13</b>	Silver, M1	+\$0	<b>M40</b>	Latte, M4	+\$0
<b>M21</b>	Black, M2	+\$0	<b>M41</b>	Cloud, M4	+\$0
<b>M22</b>	Gray, M2	+\$0	<b>M42</b>	Lemon, M4	+\$0
<b>M23</b>	White, M2	+\$0	<b>M43</b>	Apple, M4	+\$0
<b>M24</b>	Green, M2	+\$0	<b>M46</b>	Crimson Red, M4	+\$0
<b>M25</b>	Red, M2	+\$0	<b>M48</b>	Onyx, M4	+\$0
<b>M26</b>	Blue, M2	+\$0	<b>M49</b>	Dove, M4	+\$0
<b>M27</b>	Orange, M2	+\$0	<b>M50</b>	Azure, M4	+\$0
<b>M28</b>	Aqua, M2	+\$0	<b>M51</b>	Federal Blue, M4	+\$0
<b>M31</b>	Graphite, M3	+\$0	<b>M52</b>	White Whisper, M4	+\$0

### CASTER OPTIONS

CODE	DESCRIPTION	PRICE
<b>C5</b>	Carpet Casters	+\$45
<b>C5S</b>	Hard Floor and Carpet Casters*	+\$75

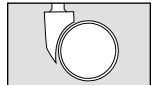
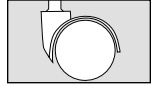

### ADDITIONAL OPTIONS

CODE	DESCRIPTION	PRICE
<b>G19B</b>	Tapered Plastic Glide • Black	+\$0
<b>G19G</b>	Tapered Plastic Glide • Gray	+\$0
<b>G19BN</b>	Swivel Nylon Glide • Black Nylon	+\$20
<b>G19GN</b>	Swivel Nylon Glide • Gray Nylon	+\$20
<b>G19BS</b>	Swivel Steel Glide • Black Steel	+\$20
<b>G19GS</b>	Swivel Steel Glide • Gray Steel	+\$20
<b>G19BF</b>	Swivel Felt Glide • Black Felt	+\$20
<b>G19GF</b>	Swivel Felt Glide • Gray Felt	+\$20

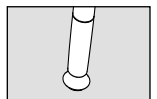
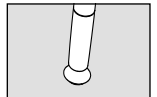
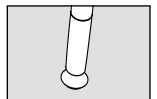
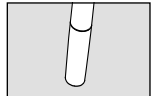

### ACCESSORIES

CODE	DESCRIPTION	PRICE
<b>G1</b>	Ganging Clip • 2 per Set • Armless-to-Armless	+\$30
<b>G2</b>	Ganging Clip • 2 per Set • Arm-to-Arm	+\$30
<b>DL5</b>	Stacking Dolly • Stacks 6 armless • Stacks 5 armed	+\$399

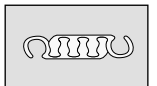



# Core

CONTEMPORARY LINES FOR  
YOUR WORKSPACE

## UPHOLSTERED BACK

- Task, stool, conference and executive seating
- Poly outer back
- Ratchet back lumbar height adjustment
- Molded foam back over mesh suspension
- Hubless casters standard
- Warranted to 300 lbs.

Webpage



GSA SIN # 33721

### MODEL / CONTROL

### ARMS MATERIAL

### DIMENSIONS

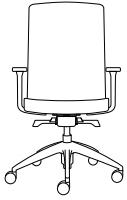

#### 2260 / W1 Weight-Balanced Synchro Tilt

- Automatic tension adjustment
- 2-position tilt lock
- 3:1 back-to-seat tilt ratio
- 360° swivel
- Pneumatic cylinder height adjustment

	A	B/COM	C	D	E	F	G	L3/COL	L4	L5
A00	\$880	\$920	\$950	\$990	\$1050	\$1110	\$1165	\$1055	\$1180	\$1280
A22B	\$950	\$990	\$1020	\$1060	\$1120	\$1180	\$1235	\$1125	\$1250	\$1350
A23B	\$975	\$1015	\$1045	\$1085	\$1145	\$1205	\$1260	\$1150	\$1275	\$1375
A36	\$1005	\$1045	\$1075	\$1115	\$1175	\$1235	\$1290	\$1180	\$1305	\$1405

WIDTH: 27.5  
DEPTH: 27.5  
HEIGHT: 38.0-44.5  
SEAT WIDTH: 19.5  
SEAT DEPTH: 17.0  
SEAT HEIGHT: 15.0-19.5  
SEAT HEIGHT W/  
SEAT SLIDER: 16.0-20.5  
BACK WIDTH: 18.5  
BACK HEIGHT: 23.0  
COM: 1.3 YD  
COL: 26.0 SQ FT  
WEIGHT: 43.0 LB



#### 2260 / K2 Knee Tilt

- 4-position tilt lock
- Side knob tension adjustment
- 360° swivel
- Pneumatic cylinder height adjustment

	A	B/COM	C	D	E	F	G	L3/COL	L4	L5
A00	\$915	\$955	\$985	\$1025	\$1085	\$1145	\$1200	\$1090	\$1215	\$1315
A22B	\$985	\$1025	\$1055	\$1095	\$1155	\$1215	\$1270	\$1160	\$1285	\$1385
A23B	\$1010	\$1050	\$1080	\$1120	\$1180	\$1240	\$1295	\$1185	\$1310	\$1410
A36	\$1040	\$1080	\$1110	\$1150	\$1210	\$1270	\$1325	\$1215	\$1340	\$1440

WIDTH: 27.5  
DEPTH: 27.5  
HEIGHT: 40.5-47.0  
SEAT WIDTH: 19.5  
SEAT DEPTH: 17.0  
SEAT HEIGHT: 17.5-22.5  
SEAT HEIGHT W/  
SEAT SLIDER: 18.0-23.0  
BACK WIDTH: 18.5  
BACK HEIGHT: 23.0  
COM: 1.3 YD  
COL: 26.0 SQ FT  
WEIGHT: 43.0 LB

# Core

## UPHOLSTERED BACK

Webpage



GSA SIN # 33721



### ARM OPTIONS

CODE	DESCRIPTION	PRICE	
<b>A22B</b>	Fixed Arm with Soft Pad • Black	+\$70	
<b>A23B</b>	6-Way Height Adjustable Arm w/ Sliding Pad • Black	+\$95	
<b>A36</b>	Height Adjustable Pivot/Slide Arm	+\$125	

### PLASTIC COLORS

CODE	DESCRIPTION	PRICE
<b>PBK</b>	Black • Outer back & arms	+\$0

### STOOL OPTIONS

CODE	DESCRIPTION	PRICE	
<b>CY30</b>	8" Stool • (Seat Height: 22"-30") • Use for work surfaces up to 36"	+\$125	
<b>CY36</b>	10" Stool • (Seat Height: 25"-36") • Use for work surfaces up to 42"	+\$125	

### BASE OPTIONS

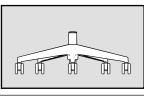
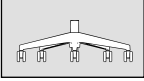
CODE	DESCRIPTION	PRICE	
<b>BA11B</b>	27" Mid-Profile Nylon • Black	+\$0	
<b>BA12P</b>	27" Mid-Profile Aluminum Base • Polished	+\$110	

### CASTER OPTIONS

CODE	DESCRIPTION	PRICE	
<b>C6</b>	Large Diameter Carpet Casters	+\$0	
<b>C6S</b>	Large Diameter Hard Floor and Carpet Casters	+\$35	
<b>C7</b>	Chrome-Accented Hard Floor and Carpet Casters	+\$35	
<b>C22B</b>	Hubless Hard Floor and Carpet Casters • Black	+\$0	
<b>C22G</b>	Hubless Hard Floor and Carpet Casters • Gray	+\$0	

### ADDITIONAL OPTIONS

CODE	DESCRIPTION	PRICE	
<b>SS</b>	Seat Slider 2.5" • Side Paddle Activated • Seat slider not available with stools	+\$60	



# Cortina

SIMPLE, STRAIGHTFORWARD  
ERGONOMICS AND  
FUNCTIONALITY

## MID-BACK

- Task, conference and executive seating
- Polished aluminum base standard
- Clean, graceful lines
- Mid- or high-back options
- Warranted to 300 lbs.

Webpage



GSA SIN # 33721

### MODEL / CONTROL

### ARMS MATERIAL

### DIMENSIONS

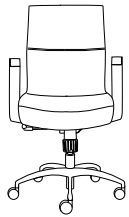

#### 2900 / S2

##### Mid-Back Swivel Tilt

- Upright lock
- Center knob tension adjustment
- 360° swivel
- Pneumatic cylinder height adjustment

	A	B/COM	C	D	E	F	G	L3/COL	L4	L5
A00	\$1034	\$1089	\$1129	\$1179	\$1244	\$1324	\$1394	\$1269	\$1319	\$1474
A8B/S	\$1139	\$1194	\$1234	\$1284	\$1349	\$1429	\$1499	\$1374	\$1424	\$1579
A9B/S	\$1149	\$1204	\$1244	\$1294	\$1359	\$1439	\$1509	\$1384	\$1434	\$1589
A16	\$1159	\$1214	\$1254	\$1304	\$1369	\$1449	\$1519	\$1394	\$1444	\$1599
A19	\$1269	\$1324	\$1364	\$1414	\$1479	\$1559	\$1629	\$1504	\$1554	\$1709
A36	\$1159	\$1214	\$1254	\$1304	\$1369	\$1449	\$1519	\$1394	\$1444	\$1599
A37	\$1174	\$1229	\$1269	\$1319	\$1384	\$1464	\$1534	\$1409	\$1459	\$1614
A90	\$1269	\$1324	\$1364	\$1414	\$1479	\$1559	\$1629	\$1504	\$1554	\$1709

WIDTH: 25.0  
DEPTH: 26.0  
HEIGHT: 39.0-43.5  
SEAT WIDTH: 20.5  
SEAT DEPTH: 19.0  
SEAT HEIGHT: 18.0-22.5  
BACK WIDTH: 18.5  
BACK HEIGHT: 21.0  
COM: 1.5 YD  
COL: 33.0 SQ FT  
WEIGHT: 44.0 LB

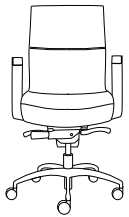

#### 2900 / Y2

##### Mid-Back Heavy Duty Synchro Tilt

- 4-position tilt lock
- Side knob tension adjustment
- 2:1 back-to-seat tilt ratio
- 360° swivel
- Pneumatic cylinder height adjustment

	A	B/COM	C	D	E	F	G	L3/COL	L4	L5
A00	\$1114	\$1169	\$1209	\$1259	\$1324	\$1404	\$1474	\$1349	\$1399	\$1554
A8B/S	\$1219	\$1274	\$1314	\$1364	\$1429	\$1509	\$1579	\$1454	\$1504	\$1659
A9B/S	\$1229	\$1284	\$1324	\$1374	\$1439	\$1519	\$1589	\$1464	\$1514	\$1669
A16	\$1239	\$1294	\$1334	\$1384	\$1449	\$1529	\$1599	\$1474	\$1524	\$1679
A19	\$1349	\$1404	\$1444	\$1494	\$1559	\$1639	\$1709	\$1584	\$1634	\$1789
A36	\$1239	\$1294	\$1334	\$1384	\$1449	\$1529	\$1599	\$1474	\$1524	\$1679
A37	\$1254	\$1309	\$1349	\$1399	\$1464	\$1544	\$1614	\$1489	\$1539	\$1694
A90	\$1349	\$1404	\$1444	\$1494	\$1559	\$1639	\$1709	\$1584	\$1634	\$1789

WIDTH: 25.0  
DEPTH: 26.0  
HEIGHT: 39.0-43.5  
SEAT WIDTH: 20.5  
SEAT DEPTH: 19.0  
SEAT HEIGHT: 18.0-22.5  
BACK WIDTH: 18.5  
BACK HEIGHT: 21.0  
COM: 1.5 YD  
COL: 33.0 SQ FT  
WEIGHT: 49.0 LB



#### 2900 / M1

##### Mid-Back Multi-Function

- Infinite back angle adjustment
- 6° forward tilt
- Center knob tension adjustment
- 360° swivel
- Pneumatic cylinder height adjustment

	A	B/COM	C	D	E	F	G	L3/COL	L4	L5
A00	\$1134	\$1189	\$1229	\$1279	\$1344	\$1424	\$1494	\$1369	\$1419	\$1574
A8B/S	\$1239	\$1294	\$1334	\$1384	\$1449	\$1529	\$1599	\$1474	\$1524	\$1679
A9B/S	\$1249	\$1304	\$1344	\$1394	\$1459	\$1539	\$1609	\$1484	\$1534	\$1689
A16	\$1259	\$1314	\$1354	\$1404	\$1469	\$1549	\$1619	\$1494	\$1544	\$1699
A19	\$1369	\$1424	\$1464	\$1514	\$1579	\$1659	\$1729	\$1604	\$1654	\$1809
A36	\$1259	\$1314	\$1354	\$1404	\$1469	\$1549	\$1619	\$1494	\$1544	\$1699
A37	\$1274	\$1329	\$1369	\$1419	\$1484	\$1564	\$1634	\$1509	\$1559	\$1714
A90	\$1369	\$1424	\$1464	\$1514	\$1579	\$1659	\$1729	\$1604	\$1654	\$1809

WIDTH: 25.0  
DEPTH: 26.0  
HEIGHT: 39.0-43.5  
SEAT WIDTH: 20.5  
SEAT DEPTH: 19.0  
SEAT HEIGHT: 18.5-23.0  
BACK WIDTH: 18.5  
BACK HEIGHT: 21.0  
COM: 1.5 YD  
COL: 33.0 SQ FT  
WEIGHT: 52.0 LB

# Cortina







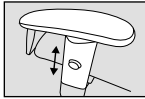
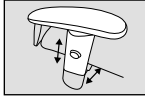

## MID-BACK

Webpage

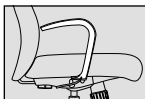

GSA SIN # 33721



### ARM OPTIONS

CODE	DESCRIPTION	PRICE	
<b>A8B</b>	Height Adjustable Arm • Black	+\$105	
<b>A8S</b>	Height Adjustable Arm • Silver	+\$105	
<b>A9B</b>	Height/Width Adjustable Arm • Black	+\$115	
<b>A9S</b>	Height/Width Adjustable Arm • Silver	+\$115	
<b>A16</b>	Soff Touch C-Shape Arm	+\$125	
<b>A19</b>	Polished Aluminum C-Shape Arm with Black Urethane Surface	+\$235	
<b>A36</b>	Height Adjustable Pivot/Slide Arm	+\$125	
<b>A37</b>	Height/Width Adjustable Pivot/Slide Arm	+\$140	
<b>A90</b>	Height/Width Adjustable Breakaway Arm	+\$240	

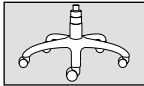
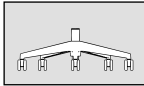
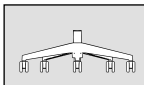
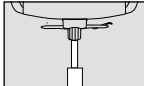
### BASE OPTIONS

CODE	DESCRIPTION	PRICE	
<b>BA1B</b>	26" Nylon Base • Black • Only C1 casters available	-\$50	
<b>BA11B</b>	27" Mid-Profile Nylon • Black	-\$50	
<b>BA12P</b>	27" Mid-Profile Aluminum Base • Polished • C7 Chrome-Accented Casters Standard with Polished Base	+\$0	
<b>JB1</b>	Jury Base	+\$300	

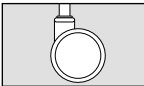
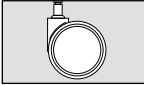
### CASTER OPTIONS

CODE	DESCRIPTION	PRICE	
<b>C6</b>	Large Diameter Carpet Casters	+\$0	
<b>C6S</b>	Large Diameter Hard Floor and Carpet Casters	+\$35	
<b>C7</b>	Chrome-Accented Hard Floor and Carpet Casters	+\$0	



# Cortina

SIMPLE, STRAIGHTFORWARD  
ERGONOMICS AND  
FUNCTIONALITY

## HIGH-BACK

- Task, conference and executive seating
- Polished aluminum base standard
- Clean, graceful lines
- Mid- or high-back options
- Warranted to 300 lbs.

Webpage



GSA SIN # 33721

### MODEL / CONTROL

### ARMS MATERIAL

### DIMENSIONS

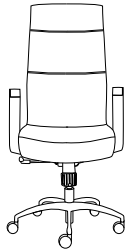

#### 2910 / S2

##### High-Back Swivel Tilt

- Upright lock
- Center knob tension adjustment
- 360° swivel
- Pneumatic cylinder height adjustment

	A	B/COM	C	D	E	F	G	L3/COL	L4	L5
A00	\$1084	\$1144	\$1189	\$1244	\$1349	\$1439	\$1529	\$1329	\$1379	\$1564
A8B/S	\$1189	\$1249	\$1294	\$1349	\$1454	\$1544	\$1634	\$1434	\$1484	\$1669
A9B/S	\$1199	\$1259	\$1304	\$1359	\$1464	\$1554	\$1644	\$1444	\$1494	\$1679
A16	\$1209	\$1269	\$1314	\$1369	\$1474	\$1564	\$1654	\$1454	\$1504	\$1689
A19	\$1319	\$1379	\$1424	\$1479	\$1584	\$1674	\$1764	\$1564	\$1614	\$1799
A36	\$1209	\$1269	\$1314	\$1369	\$1474	\$1564	\$1654	\$1454	\$1504	\$1689
A37	\$1224	\$1284	\$1329	\$1384	\$1489	\$1579	\$1669	\$1469	\$1519	\$1704
A90	\$1319	\$1379	\$1424	\$1479	\$1584	\$1674	\$1764	\$1564	\$1614	\$1799

WIDTH: 25.0  
DEPTH: 25.0  
HEIGHT: 47.0-51.5  
SEAT WIDTH: 20.5  
SEAT DEPTH: 19.0  
SEAT HEIGHT: 18.5-23.0  
BACK WIDTH: 18.5  
BACK HEIGHT: 29.0  
COM: 1.7 YD  
COL: 40.0 SQ FT  
WEIGHT: 48.0 LB

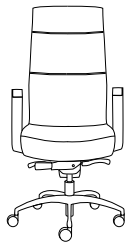

#### 2910 / Y2

##### High-Back Heavy Duty Synchro Tilt

- 4-position tilt lock
- Side knob tension adjustment
- 2:1 back-to-seat tilt ratio
- 360° swivel
- Pneumatic cylinder height adjustment

	A	B/COM	C	D	E	F	G	L3/COL	L4	L5
A00	\$1164	\$1224	\$1269	\$1324	\$1429	\$1519	\$1609	\$1409	\$1459	\$1644
A8B/S	\$1269	\$1329	\$1374	\$1429	\$1534	\$1624	\$1714	\$1514	\$1564	\$1749
A9B/S	\$1279	\$1339	\$1384	\$1439	\$1544	\$1634	\$1724	\$1524	\$1574	\$1759
A16	\$1289	\$1349	\$1394	\$1449	\$1554	\$1644	\$1734	\$1534	\$1584	\$1769
A19	\$1399	\$1459	\$1504	\$1559	\$1664	\$1754	\$1844	\$1644	\$1694	\$1879
A36	\$1289	\$1349	\$1394	\$1449	\$1554	\$1644	\$1734	\$1534	\$1584	\$1769
A37	\$1304	\$1364	\$1409	\$1464	\$1569	\$1659	\$1749	\$1549	\$1599	\$1784
A90	\$1399	\$1459	\$1504	\$1559	\$1664	\$1754	\$1844	\$1644	\$1694	\$1879

WIDTH: 25.0  
DEPTH: 25.0  
HEIGHT: 47.0-51.5  
SEAT WIDTH: 20.5  
SEAT DEPTH: 19.0  
SEAT HEIGHT: 18.0-22.5  
BACK WIDTH: 18.5  
BACK HEIGHT: 29.0  
COM: 1.7 YD  
COL: 40.0 SQ FT  
WEIGHT: 53.0 LB

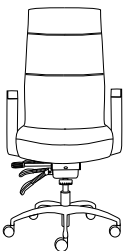

#### 2910 / M1

##### High-Back Multi-Function

- Infinite back angle adjustment
- 6° forward tilt
- Center knob tension adjustment
- 360° swivel
- Pneumatic cylinder height adjustment

	A	B/COM	C	D	E	F	G	L3/COL	L4	L5
A00	\$1184	\$1244	\$1289	\$1344	\$1449	\$1539	\$1629	\$1429	\$1479	\$1664
A8B/S	\$1289	\$1349	\$1394	\$1449	\$1554	\$1644	\$1734	\$1534	\$1584	\$1769
A9B/S	\$1299	\$1359	\$1404	\$1459	\$1564	\$1654	\$1744	\$1544	\$1594	\$1779
A16	\$1309	\$1369	\$1414	\$1469	\$1574	\$1664	\$1754	\$1554	\$1604	\$1789
A19	\$1419	\$1479	\$1524	\$1579	\$1684	\$1774	\$1864	\$1664	\$1714	\$1899
A36	\$1309	\$1369	\$1414	\$1469	\$1574	\$1664	\$1754	\$1554	\$1604	\$1789
A37	\$1324	\$1384	\$1429	\$1484	\$1589	\$1679	\$1769	\$1569	\$1619	\$1804
A90	\$1419	\$1479	\$1524	\$1579	\$1684	\$1774	\$1864	\$1664	\$1714	\$1899

WIDTH: 25.0  
DEPTH: 25.0  
HEIGHT: 47.0-51.5  
SEAT WIDTH: 20.5  
SEAT DEPTH: 19.0  
SEAT HEIGHT: 18.5-23.0  
BACK WIDTH: 18.5  
BACK HEIGHT: 29.0  
COM: 1.7 YD  
COL: 40.0 SQ FT  
WEIGHT: 56.0 LB

# Cortina







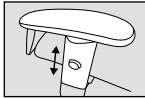
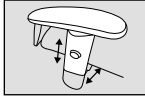

## HIGH-BACK

Webpage

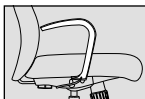

GSA SIN # 33721

### ARM OPTIONS

CODE	DESCRIPTION	PRICE	
<b>A8B</b>	Height Adjustable Arm • Black	+\$105	
<b>A8S</b>	Height Adjustable Arm • Silver	+\$105	
<b>A9B</b>	Height/Width Adjustable Arm • Black	+\$115	
<b>A9S</b>	Height/Width Adjustable Arm • Silver	+\$115	
<b>A16</b>	Soft Touch C-Shape Arm	+\$125	
<b>A19</b>	Polished Aluminum C-Shape Arm with Black Urethane Surface	+\$235	
<b>A36</b>	Height Adjustable Pivot/Slide Arm	+\$125	
<b>A37</b>	Height/Width Adjustable Pivot/Slide Arm	+\$140	
<b>A90</b>	Height/Width Adjustable Breakaway Arm	+\$240	

### BASE OPTIONS

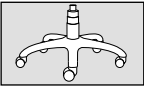
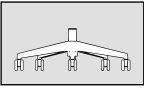
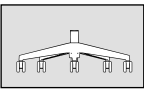
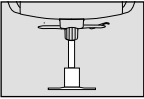
CODE	DESCRIPTION	PRICE	
<b>BA1B</b>	26" Nylon Base • Black • Only C1 casters available	-\$50	
<b>BA11B</b>	27" Mid-Profile Nylon • Black	-\$50	
<b>BA12P</b>	27" Mid-Profile Aluminum Base • Polished • C7 Chrome-Accented Casters Standard with Polished Base	+\$0	
<b>JB1</b>	Jury Base	+\$300	

### CASTER OPTIONS

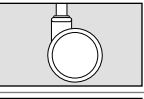
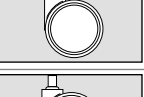
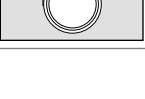
CODE	DESCRIPTION	PRICE	
<b>C6</b>	Large Diameter Carpet Casters	+\$0	
<b>C6S</b>	Large Diameter Hard Floor and Carpet Casters	+\$35	
<b>C7</b>	Chrome-Accented Hard Floor and Carpet Casters	+\$0	



# Cydia

ORGANIC DESIGN MEETS  
ERGONOMIC EXCELLENCE

## MID-BACK

- Task, stool, conference, and executive seating
- Mesh or upholstered back options
- Three designer frame colors
- Mid-back and high-back sizes
- Warranted to 300 lbs.

Webpage



GSA SIN # 33721

### MODEL / CONTROL

### ARMS MATERIAL

### DIMENSIONS

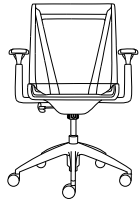

#### 3300 / S3

Mesh Back - MB &  
Mesh Seat - MS  
Mid-Back Swivel Tilt

- Upright lock
- Center knob tension adjustment
- 360° swivel
- Pneumatic cylinder height adjustment

	M											
A00	\$924											
A34	\$1019											
A35	\$1049											

WIDTH: 28.0  
DEPTH: 27.5  
HEIGHT: 34.0-38.5  
SEAT WIDTH: 19.0  
SEAT DEPTH: 16.0  
SEAT HEIGHT: 17.0-21.5  
BACK WIDTH: 18.0  
BACK HEIGHT: 19.5  
COM: N/A  
WEIGHT: 23.0 LB

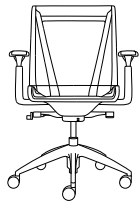

#### 3300 / K3

Mesh Back - MB &  
Mesh Seat - MS  
Mid-Scale Knee Tilt

- 4-position tilt lock
- Side knob tension adjustment
- 360° swivel
- Pneumatic cylinder height adjustment

	M											
A00	\$1024											
A34	\$1119											
A35	\$1149											

WIDTH: 28.0  
DEPTH: 27.5  
HEIGHT: 36.0-40.5  
SEAT WIDTH: 19.0  
SEAT DEPTH: 16.0  
SEAT HEIGHT: 18.0-22.5  
BACK WIDTH: 19.0  
BACK HEIGHT: 19.5  
COM: N/A  
WEIGHT: 30.0 LB

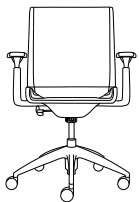

#### 3300 / S3

Upholstered Back - UB &  
Upholstered Seat - US  
Mid-Back Swivel Tilt

- Upright lock
- Center knob tension adjustment
- 360° swivel
- Pneumatic cylinder height adjustment

	A	B/COM	C	D	E	F	G	L3/COL	L4	L5		
A00	\$1128	\$1173	\$1203	\$1243	\$1293	\$1348	\$1418	\$1373	\$1423	\$1768		
A34	\$1223	\$1268	\$1298	\$1338	\$1388	\$1443	\$1513	\$1418	\$1518	\$1863		
A35	\$1253	\$1298	\$1328	\$1368	\$1418	\$1473	\$1543	\$1448	\$1548	\$1893		

WIDTH: 28.0  
DEPTH: 27.5  
HEIGHT: 34.0-38.5  
SEAT WIDTH: 19.0  
SEAT DEPTH: 16.0  
SEAT HEIGHT: 17.5-22.0  
BACK WIDTH: 18.0  
BACK HEIGHT: 19.5  
COM: 1.5 YD  
COL: 12.0 SQ FT  
WEIGHT: 36.0 LB

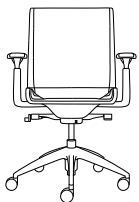

#### 3300 / K3

Upholstered Back - UB &  
Upholstered Seat - US  
Mid-Back Knee Tilt

- 4-position tilt lock
- Side knob tension adjustment
- 360° swivel
- Pneumatic cylinder height adjustment

	A	B/COM	C	D	E	F	G	L3/COL	L4	L5		
A00	\$1228	\$1273	\$1303	\$1343	\$1393	\$1448	\$1518	\$1423	\$1523	\$1868		
A34	\$1323	\$1368	\$1398	\$1438	\$1488	\$1543	\$1613	\$1518	\$1618	\$1963		
A35	\$1353	\$1398	\$1428	\$1468	\$1518	\$1573	\$1643	\$1548	\$1648	\$1993		

WIDTH: 28.0  
DEPTH: 27.5  
HEIGHT: 36.0-40.5  
SEAT WIDTH: 19.0  
SEAT DEPTH: 16.0  
SEAT HEIGHT: 18.5-23.0  
BACK WIDTH: 19.0  
BACK HEIGHT: 19.5  
COM: 1.5 YD  
COL: 12.0 SQ FT  
WEIGHT: 43.0 LB



### ARM OPTIONS

CODE	DESCRIPTION	PRICE
<b>A34B</b>	Nylon Loop Arm • Black	+\$95
<b>A34G</b>	Nylon Loop Arm • Graphite Gray	+\$95
<b>A34W</b>	Nylon Loop Arm • White	+\$95
<b>A35B</b>	Height Adjustable Arm • Black	+\$125
<b>A35G</b>	Height Adjustable Arm • Graphite Gray	+\$125
<b>A35W</b>	Height Adjustable Arm • White	+\$125

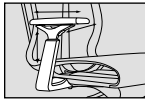

### PLASTIC COLORS (BACK/SEAT FRAME AND ARMS)

CODE	DESCRIPTION	PRICE
<b>PBK</b>	Black	+\$0
<b>PGG</b>	Graphite Gray	+\$35
<b>PBK</b>	White	+\$35

### MESH COLORS

CODE	DESCRIPTION	PRICE
<b>M11</b>	Black, M1	+\$0
<b>M12</b>	Gray, M1	+\$0
<b>M13</b>	Silver, M1	+\$0
<b>M31</b>	Graphite, M3	+\$30
<b>M32</b>	Slate, M3	+\$30
<b>M33</b>	Snow, M3	+\$30

### STOOL OPTIONS

CODE	DESCRIPTION	PRICE
<b>CY30B</b>	8" Stool • (Seat Height: 22"-30") • Use for work surfaces up to 36"	+\$125
<b>CY36B</b>	10" Stool • (Seat Height: 25"-36") • Use for work surfaces up to 42"	+\$125



### BASE OPTIONS

CODE	DESCRIPTION	PRICE
<b>BA11B</b>	27" Mid-Profile Nylon • Black	+\$0
<b>BA11G</b>	27" Mid-Profile Nylon • Graphite Gray	+\$0
<b>BA12B</b>	27" Mid-Profile Aluminum Base • Black	+\$110
<b>BA12P</b>	27" Mid-Profile Aluminum Base • Polished	+\$110
<b>BA12S</b>	27" Mid-Profile Aluminum Base • Silver	+\$110

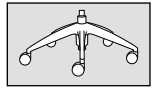
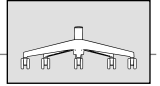

### CASTER OPTIONS

CODE	DESCRIPTION	PRICE
<b>C6</b>	Large Diameter Carpet Casters	+\$0
<b>C6S</b>	Large Diameter Hard Floor and Carpet Casters	+\$35
<b>C7</b>	Chrome-Accented Hard Floor and Carpet Casters	+\$35

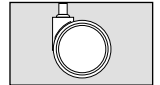
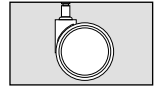
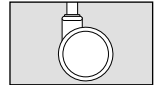

### ADDITIONAL OPTIONS

CODE	DESCRIPTION	PRICE
<b>LB</b>	Height Adjustable Lumbar • Factory Installed	+\$30
<b>G1</b>	Stationary Base Glide	+\$30

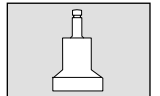
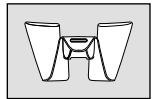



# Cydia

ORGANIC DESIGN MEETS  
ERGONOMIC EXCELLENCE

## HIGH-BACK

- Task, stool, conference, and executive seating
- Mesh or upholstered back options
- Three designer frame colors
- Mid-back and high-back sizes
- Warranted to 300 lbs.

Webpage



GSA SIN # 33721

### MODEL / CONTROL

### ARMS MATERIAL

### DIMENSIONS

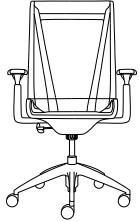

#### 3310 / S3

##### Mesh Back - MB & Mesh Seat - MS High-Back Swivel Tilt

- Upright lock
- Center knob tension adjustment
- 360° swivel
- Pneumatic cylinder height adjustment

	M											
A00	\$974											
A34	\$1069											
A35	\$1099											

WIDTH: 28.0  
DEPTH: 27.5  
HEIGHT: 39.5-44.0  
SEAT WIDTH: 19.0  
SEAT DEPTH: 17.0  
SEAT HEIGHT: 17.0-21.5  
BACK WIDTH: 18.0  
BACK HEIGHT: 23.5  
COM: N/A  
WEIGHT: 26.0 LB

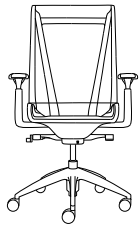

#### 3310 / K3

##### Mesh Back - MB & Mesh Seat - MS High-Back Knee Tilt

- 4-position tilt lock
- Side knob tension adjustment
- 360° swivel
- Pneumatic cylinder height adjustment

	M											
A00	\$1074											
A34	\$1169											
A35	\$1199											

WIDTH: 28.0  
DEPTH: 27.5  
HEIGHT: 41.5-46.0  
SEAT WIDTH: 19.0  
SEAT DEPTH: 17.0  
SEAT HEIGHT: 18.0-22.5  
BACK WIDTH: 18.0  
BACK HEIGHT: 23.5  
COM: N/A  
WEIGHT: 33.0 LB

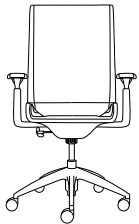

#### 3310 / S3

##### Upholstered Back - UB & Upholstered Seat - US High-Back Swivel Tilt

- Upright lock
- Center knob tension adjustment
- 360° swivel
- Pneumatic cylinder height adjustment

	A	B/COM	C	D	E	F	G	L3/COL	L4	L5		
A00	\$1178	\$1223	\$1253	\$1293	\$1343	\$1398	\$1468	\$1373	\$1473	\$1818		
A34	\$1273	\$1318	\$1348	\$1388	\$1438	\$1493	\$1563	\$1468	\$1568	\$1913		
A35	\$1303	\$1348	\$1378	\$1418	\$1468	\$1523	\$1593	\$1498	\$1598	\$1943		

WIDTH: 28.0  
DEPTH: 27.5  
HEIGHT: 39.5-44.0  
SEAT WIDTH: 19.0  
SEAT DEPTH: 17.0  
SEAT HEIGHT: 17.5-22.0  
BACK WIDTH: 18.0  
BACK HEIGHT: 23.5  
COM: 1.7 YD  
COL: 14.0 SQ FT  
WEIGHT: 39.0 LB

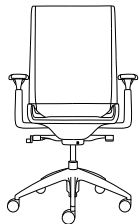

#### 3310 / K3

##### Upholstered Back - UB & Upholstered Seat - US High-Back Knee Tilt

- 4-position tilt lock
- Side knob tension adjustment
- 360° swivel
- Pneumatic cylinder height adjustment

	A	B/COM	C	D	E	F	G	L3/COL	L4	L5		
A00	\$1278	\$1323	\$1353	\$1393	\$1443	\$1498	\$1568	\$1473	\$1573	\$1918		
A34	\$1373	\$1418	\$1448	\$1488	\$1538	\$1593	\$1663	\$1568	\$1668	\$2013		
A35	\$1403	\$1448	\$1478	\$1518	\$1568	\$1623	\$1693	\$1598	\$1698	\$2043		

WIDTH: 28.0  
DEPTH: 27.5  
HEIGHT: 41.5-46.0  
SEAT WIDTH: 19.0  
SEAT DEPTH: 17.0  
SEAT HEIGHT: 18.5-23.0  
BACK WIDTH: 18.0  
BACK HEIGHT: 23.5  
COM: 1.7 YD  
COL: 14.0 SQ FT  
WEIGHT: 46.0 LB

# Cydia

## HIGH-BACK

Webpage



GSA SIN # 33721

### ARM OPTIONS

CODE	DESCRIPTION	PRICE
<b>A34B</b>	Nylon Loop Arm • Black	+\$95
<b>A34G</b>	Nylon Loop Arm • Graphite Gray	+\$95
<b>A34W</b>	Nylon Loop Arm • White	+\$95
<b>A35B</b>	Height Adjustable Arm • Black	+\$125
<b>A35G</b>	Height Adjustable Arm • Graphite Gray	+\$125
<b>A35W</b>	Height Adjustable Arm • White	+\$125

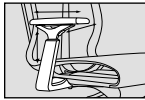

### PLASTIC COLORS (BACK/SEAT FRAME AND ARMS)

CODE	DESCRIPTION	PRICE
<b>PBK</b>	Black	+\$0
<b>PGG</b>	Graphite Gray	+\$35
<b>PBK</b>	White	+\$35

### MESH COLORS

CODE	DESCRIPTION	PRICE
<b>M11</b>	Black, M1	+\$0
<b>M12</b>	Gray, M1	+\$0
<b>M13</b>	Silver, M1	+\$0
<b>M31</b>	Graphite, M3	+\$30
<b>M32</b>	Slate, M3	+\$30
<b>M33</b>	Snow, M3	+\$30

### STOOL OPTIONS

CODE	DESCRIPTION	PRICE
<b>CY30B</b>	8" Stool • (Seat Height: 22"-30") • Use for work surfaces up to 36"	+\$125
<b>CY36B</b>	10" Stool • (Seat Height: 25"-36") • Use for work surfaces up to 42"	+\$125



### BASE OPTIONS

CODE	DESCRIPTION	PRICE
<b>BA11B</b>	27" Mid-Profile Nylon • Black	+\$0
<b>BA11G</b>	27" Mid-Profile Nylon • Graphite Gray	+\$0
<b>BA12B</b>	27" Mid-Profile Aluminum Base • Black	+\$110
<b>BA12P</b>	27" Mid-Profile Aluminum Base • Polished	+\$110
<b>BA12S</b>	27" Mid-Profile Aluminum Base • Silver	+\$110

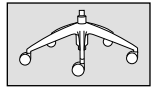
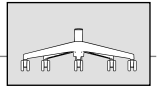

### CASTER OPTIONS

CODE	DESCRIPTION	PRICE
<b>C6</b>	Large Diameter Carpet Casters	+\$0
<b>C6S</b>	Large Diameter Hard Floor and Carpet Casters	+\$35
<b>C7</b>	Chrome-Accented Hard Floor and Carpet Casters	+\$35

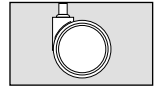
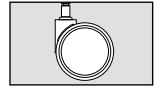
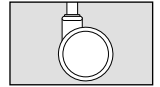

### ADDITIONAL OPTIONS

CODE	DESCRIPTION	PRICE
<b>LB</b>	Height Adjustable Lumbar • Factory Installed	+\$30
<b>G1</b>	Stationary Base Glide	+\$30

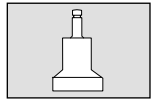
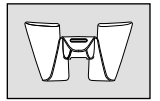



# Dash

A COOL SIT WITH A MODERN LOOK



## 4 LEG

- Stacking side, guest, task and stool
- Perforated breathable back
- Flexback movement
- All plastic and upholstered seat options
- Pull handle for easy mobility
- Warranted to 300 lbs.

Webpage





GSA SIN # 33721 PENDING

MODEL / CHAIR TYPE	ARMS	MATERIAL											DIMENSIONS			
 <p><b>1130 / FRM</b> Plastic Back - PB &amp; Plastic Seat - PS Stacking</p> <ul style="list-style-type: none"> <li>• Stacks 4 high on the floor</li> <li>• Stacks 8 high on the optional stacking dolly</li> <li>• Arms and glides coordinate with the frame color</li> <li>• Non-marring floor glides</li> </ul>		<b>P</b>													<b>ARMLESS</b>	<b>ARMS</b>
	A00	\$329													WIDTH: 21.0	22.5
	A53	\$384													DEPTH: 21.0	21.0
															HEIGHT: 34.0	34.0
 <p><b>1130 / FRM</b> Plastic Back - PB &amp; Upholstered Seat - US Stacking</p> <ul style="list-style-type: none"> <li>• Stacks 4 high on the floor</li> <li>• Stacks 8 high on the optional stacking dolly</li> <li>• Arms and glides coordinate with the frame color</li> <li>• Non-marring floor glides</li> </ul>		<b>A</b>	<b>B/COM</b>	<b>C</b>	<b>D</b>	<b>E</b>	<b>F</b>	<b>G</b>	<b>L3/COL</b>	<b>L4</b>	<b>L5</b>			<b>ARMLESS</b>	<b>ARMS</b>	
	A00	\$394	\$416	\$439	\$469	\$504	\$539	\$569	\$544	\$594	\$664			WIDTH: 21.0	22.5	
	A53	\$449	\$471	\$494	\$524	\$559	\$594	\$624	\$599	\$649	\$719			DEPTH: 21.0	21.0	
														HEIGHT: 34.0	34.0	
														SEAT WIDTH: 18.0	18.0	
														SEAT DEPTH: 16.0	16.0	
														SEAT HEIGHT: 18.0	18.0	
														BACK WIDTH: 18.0	18.0	
														BACK HEIGHT: 17.5	17.5	
														COM: 0.5 YD	0.5 YD	
														COL: 3.91 SQ FT	3.91 SQ FT	
														WEIGHT: 16.0 LB	18.0 LB	



### ARM OPTIONS

CODE	DESCRIPTION	PRICE	
<b>A53B</b>	Nylon Fixed Arm for 4 leg models • Black	+\$0	
<b>A53G</b>	Nylon Fixed Arm for 4 leg models • Cloud Gray	+\$0	
<b>A54B</b>	Nylon Fixed Arm for sled models • Black	+\$0	
<b>A54G</b>	Nylon Fixed Arm for sled models • Cloud Gray	+\$0	

### FRAME COLORS

CODE	DESCRIPTION	PRICE
<b>4LGB</b>	Black	+\$0
<b>4LGS</b>	Silver	+\$0

### PLASTIC COLORS

CODE	DESCRIPTION	PRICE
<b>P01</b>	Black Swan	+\$0
<b>P05</b>	White Whisper	+\$0
<b>P11</b>	Federal Blue	+\$0
<b>P12</b>	Crimson Red	+\$0
<b>P13</b>	Lemon Yellow	+\$0
<b>P14</b>	Dove Gray	+\$0
<b>P15</b>	Cloud Gray	+\$0
<b>P16</b>	Lagoon Blue	+\$0
<b>P17</b>	Apple Green	+\$0
<b>P18</b>	Tangerine Orange	+\$0
<b>P19</b>	Latte	+\$0
<b>P20</b>	Azure Blue	+\$0

### STOOL OPTIONS

CODE	DESCRIPTION	PRICE	
<b>ST24B</b>	24" Counter Stool • Black • Use for work surfaces up to 36" high	+\$130	
<b>ST24S</b>	24" Counter Stool • Silver • Use for work surfaces up to 36" high	+\$130	
<b>ST30B</b>	30" Bar Stool • Black • Use for work surfaces up to 42" high	+\$150	
<b>ST30S</b>	30" Bar Stool • Silver • Use for work surfaces up to 42" high	+\$150	

### CASTER OPTIONS

CODE	DESCRIPTION	PRICE	
<b>C12S</b>	Hard Floor and Carpet Casters	+\$45	

### ADDITIONAL OPTIONS

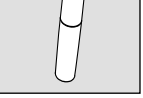
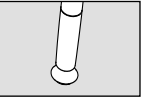
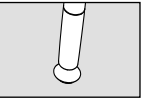
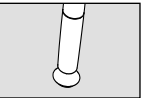
CODE	DESCRIPTION	PRICE	
<b>G21B</b>	Tapered Plastic Glide • Black	+\$0	
<b>G21G</b>	Tapered Plastic Glide • Gray	+\$0	
<b>G21BN</b>	Swivel Nylon Glide • Black	+\$20	
<b>G21GN</b>	Swivel Nylon Glide • Gray	+\$20	
<b>G21BS</b>	Swivel Steel Glide • Black	+\$20	
<b>G21GS</b>	Swivel Steel Glide • Gray	+\$20	
<b>G21BF</b>	Swivel Felt Glide • Black	+\$20	
<b>G21GF</b>	Swivel Felt Glide • Gray	+\$20	

### ACCESSORIES

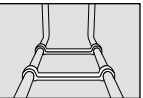
CODE	DESCRIPTION	PRICE	
<b>GC7</b>	Ganging Clip • 2 per set, for 4-leg models • Arm-to-Arm and Armless-to-Armless	+\$30	
<b>GC8</b>	Ganging Clip • 2 per set, for Sled models • Arm-to-Arm and Armless-to-Armless • 2" Between Chairs when Ganged	+\$20	
<b>DL5</b>	Stacking Dolly • Stacks up to 8 High - 4-Leg Models • Stacks up to 20 High - Sled Models	+\$399	

Due to the nature of upholstery, stacking may cause impressions on the seat. 9to5 Seating does not warrant effects of stacking on upholstery.



# Dash

A COOL SIT WITH A MODERN LOOK



## SLED

- Stacking side, guest, task and stool
- Perforated breathable back
- Flexback movement
- All plastic and upholstered seat options
- Pull handle for easy mobility
- Warranted to 300 lbs.

Webpage





GSA SIN # 33721 PENDING

MODEL / CHAIR TYPE	ARMS	MATERIAL											DIMENSIONS			
 <p><b>1130 / FRM</b> Plastic Back - PB &amp; Plastic Seat - PS Sled</p> <ul style="list-style-type: none"> <li>• Stacks 7 high on the floor</li> <li>• Stacks 20 high on the optional stacking dolly</li> <li>• Arms and glides coordinate with the frame color</li> <li>• Optional glides available</li> </ul>		<b>P</b>												<b>ARMLESS</b>	<b>ARMS</b>	
	A00	\$305												WIDTH:	21.0	22.5
	A54	\$360												DEPTH:	21.0	21.0
														HEIGHT:	36.0	36.0
														SEAT WIDTH:	18.5	18.5
														SEAT DEPTH:	16.0	16.0
														SEAT HEIGHT:	18.5	18.5
														BACK WIDTH:	18.0	18.0
														BACK HEIGHT:	17.5	17.5
														COM:	N/A	N/A
														COL:	N/A	N/A
														WEIGHT:	16.0 LB	18.0 LB
 <p><b>1130 / FRM</b> Plastic Back - PB &amp; Upholstered Seat - US Sled</p> <ul style="list-style-type: none"> <li>• Stacks 7 high on the floor</li> <li>• Stacks 20 high on the optional stacking dolly</li> <li>• Arms and glides coordinate with the frame color</li> <li>• Optional glides available</li> </ul>		<b>A</b>	<b>B/COM</b>	<b>C</b>	<b>D</b>	<b>E</b>	<b>F</b>	<b>G</b>	<b>L3/COL</b>	<b>L4</b>	<b>L5</b>		<b>ARMLESS</b>	<b>ARMS</b>		
	A00	\$370	\$392	\$415	\$445	\$480	\$515	\$545	\$520	\$570	\$640		WIDTH:	21.0	22.5	
	A54	\$425	\$447	\$470	\$500	\$535	\$570	\$600	\$575	\$625	\$695		DEPTH:	21.0	21.0	
													HEIGHT:	36.0	36.0	
													SEAT WIDTH:	18.0	18.0	
													SEAT DEPTH:	16.0	16.0	
													SEAT HEIGHT:	18.0	18.0	
													BACK WIDTH:	18.0	18.0	
													BACK HEIGHT:	17.5	17.5	
													COM:	0.5 YD	0.5 YD	
												COL:	3.91 SQ FT	3.91 SQ FT		
												WEIGHT:	16.0 LB	18.0 LB		

CAUTION: Careless stacking of chairs may scratch and damage frames. \*Due to the nature of vinyl upholstery, stacking may cause impressions on the seat. 9to5 Seating does not warrant the effects of the stacking on vinyl upholstery.



### ARM OPTIONS

CODE	DESCRIPTION	PRICE	
<b>A53B</b>	Nylon Fixed Arm for 4 leg models • Black	+\$0	
<b>A53G</b>	Nylon Fixed Arm for 4 leg models • Cloud Gray	+\$0	
<b>A54B</b>	Nylon Fixed Arm for sled models • Black	+\$0	
<b>A54G</b>	Nylon Fixed Arm for sled models • Cloud Gray	+\$0	

### FRAME COLORS - SLED

CODE	DESCRIPTION	PRICE
<b>SLDB</b>	Black	+\$0
<b>SLDS</b>	Silver	+\$0

### PLASTIC COLORS

CODE	DESCRIPTION	PRICE
<b>P01</b>	Black Swan	+\$0
<b>P05</b>	White Whisper	+\$0
<b>P11</b>	Federal Blue	+\$0
<b>P12</b>	Crimson Red	+\$0
<b>P13</b>	Lemon Yellow	+\$0
<b>P14</b>	Dove Gray	+\$0
<b>P15</b>	Cloud Gray	+\$0
<b>P16</b>	Lagoon Blue	+\$0
<b>P17</b>	Apple Green	+\$0
<b>P18</b>	Tangerine Orange	+\$0
<b>P19</b>	Latte	+\$0
<b>P20</b>	Azure Blue	+\$0

### ADDITIONAL OPTIONS

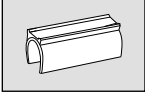
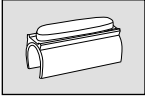
CODE	DESCRIPTION	PRICE	
<b>G16</b>	Sled Base Clear Plastic Glide • 4 per seat	+\$15	
<b>G17</b>	Sled Base Clear Plastic Glide with Felt • 4 per seat	+\$25	

### ACCESSORIES

CODE	DESCRIPTION	PRICE	
<b>GC7</b>	Ganging Clip • 2 per set, for 4-leg models • Arm-to-Arm and Armless-to-Armless	+\$30	
<b>GC8</b>	Ganging Clip • 2 per set, for Sled models • Arm-to-Arm and Armless-to-Armless • 2" Between Chairs when Ganged	+\$20	
<b>DL5</b>	Stacking Dolly • Stacks up to 8 High - 4-Leg Models • Stacks up to 20 High - Sled Models	+\$399	

Due to the nature of upholstery, stacking may cause impressions on the seat. 9to5 Seating does not warrant effects of stacking on upholstery.



# Dash

A COOL SIT WITH A MODERN LOOK

## TASK

- Stacking side, guest, task and stool
- Flexback movement
- All plastic, upholstered seat or upholstered back and seat
- Pull handle for easy mobility
- Warranted to 300 lbs.

Webpage



GSA SIN # 33721 PENDING

**MODEL / CHAIR TYPE / CONTROL    ARMS    MATERIAL    DIMENSIONS**



**1130 / TSK / B1**  
Plastic Back - PB & Plastic Seat - PS Task

- 360° swivel
- Pneumatic cylinder height adjustment
- Stool options available for \$125 upcharge. See stool option section.

	P										
A00	\$454										
A53	\$509										

	ARMLESS	ARMS
WIDTH:	26.5	28.0
DEPTH:	26.5	26.5
HEIGHT:	33.5	33.5
SEAT WIDTH:	18.0	18.0
SEAT DEPTH:	16.0	16.0
SEAT HEIGHT:	16.0-20.5	16.0-20.5
BACK WIDTH:	18.0	18.0
BACK HEIGHT:	17.5	17.5
COM:	N/A	N/A
COL:	N/A	N/A
WEIGHT:	28.0 LB	30.0 LB



**1130 / TSK / B1**  
Plastic Back - PB & Upholstered Seat - US Task

- 360° swivel
- Pneumatic cylinder height adjustment
- Stool options available for \$125 upcharge. See stool option section.

	A	B/COM	C	D	E	F	G	L3/COL	L4	L5
A00	\$519	\$541	\$564	\$594	\$629	\$664	\$694	\$669	\$719	\$789
A53	\$574	\$596	\$619	\$649	\$684	\$719	\$749	\$724	\$774	\$844

	ARMLESS	ARMS
WIDTH:	26.5	28.0
DEPTH:	26.5	26.5
HEIGHT:	34.0	34.0
SEAT WIDTH:	18.0	18.0
SEAT DEPTH:	16.0	16.0
SEAT HEIGHT:	16.0-20.5	16.0-20.5
BACK WIDTH:	18.0	18.0
BACK HEIGHT:	17.5	17.5
COM:	0.5 YD	0.5 YD
COL:	3.91 SQ FT	3.91 SQ FT
WEIGHT:	28.0 LB	30.0 LB



**1130 / TSK / S3**  
Plastic Back - PB & Plastic Seat - PS Task

- Upright lock
- Center knob tension adjustment
- 360° swivel
- Pneumatic cylinder height adjustment
- Stool options available for \$125 upcharge. See stool option section.

	P									
A00	\$489									
A53	\$544									

	ARMLESS	ARMS
WIDTH:	26.5	28.0
DEPTH:	26.5	26.5
HEIGHT:	39.0	39.0
SEAT WIDTH:	18.0	18.0
SEAT DEPTH:	16.5	16.5
SEAT HEIGHT:	21.0	21.0
BACK WIDTH:	18.0	18.0
BACK HEIGHT:	17.5	17.5
COM:	N/A	N/A
COL:	N/A	N/A
WEIGHT:	17.5 LB	19.5 LB



**1130 / TSK / S3**  
Plastic Back - PB & Upholstered Seat - US Task

- Upright lock
- Center knob tension adjustment
- 360° swivel
- Pneumatic cylinder height adjustment
- Stool options available for \$125 upcharge. See stool option section.

	A	B/COM	C	D	E	F	G	L3/COL	L4	L5
A00	\$554	\$576	\$599	\$629	\$664	\$699	\$729	\$704	\$754	\$824
A53	\$609	\$631	\$654	\$684	\$719	\$754	\$784	\$759	\$809	\$879

	ARMLESS	ARMS
WIDTH:	26.5	28.0
DEPTH:	26.5	26.5
HEIGHT:	39.0	39.0
SEAT WIDTH:	18.0	18.0
SEAT DEPTH:	16.5	16.5
SEAT HEIGHT:	21.0	21.0
BACK WIDTH:	18.0	18.0
BACK HEIGHT:	17.5	17.5
COM:	0.5 YD	0.5 YD
COL:	3.91 SQ FT	3.91 SQ FT
WEIGHT:	17.5 LB	19.0 LB



**1130 / TSK / R2**  
Plastic Back - PB & Plastic Seat - PS Task

- Rock left, right, front and back
- 360° swivel
- Pneumatic cylinder height adjustment
- Stool options available for \$125 upcharge. See stool option section.

	P									
A00	\$544									
A53	\$599									

	ARMLESS	ARMS
WIDTH:	26.5	28.0
DEPTH:	26.5	26.5
HEIGHT:	39.0	39.0
SEAT WIDTH:	18.0	18.0
SEAT DEPTH:	16.0	17.0
SEAT HEIGHT:	21.5	21.5
BACK WIDTH:	18.0	18.0
BACK HEIGHT:	17.5	17.5
COM:	N/A	N/A
COL:	N/A	N/A
WEIGHT:	24.5 LB	26.5 LB



**1130 / TSK / R2**  
Plastic Back - PB & Upholstered Seat - US Task

- Rock left, right, front and back
- 360° swivel
- Pneumatic cylinder height adjustment
- Stool options available for \$125 upcharge. See stool option section.

	A	B/COM	C	D	E	F	G	L3/COL	L4	L5
A00	\$609	\$631	\$654	\$684	\$719	\$754	\$784	\$759	\$809	\$879
A53	\$664	\$686	\$709	\$739	\$774	\$809	\$839	\$814	\$864	\$934

	ARMLESS	ARMS
WIDTH:	26.5	28.0
DEPTH:	26.5	26.5
HEIGHT:	39.0	39.0
SEAT WIDTH:	18.0	18.0
SEAT DEPTH:	17.0	17.0
SEAT HEIGHT:	21.5	21.5
BACK WIDTH:	18.0	18.0
BACK HEIGHT:	17.5	17.5
COM:	0.72 SQ FT	0.5 YD
COL:	3.91 SQ FT	3.91 SQ FT
WEIGHT:	26.0 LB	28.0 LB



### ARM OPTIONS

CODE	DESCRIPTION	PRICE
<b>A53B</b>	Nylon Fixed Arm for 4 leg models Black	+\$0
<b>A53G</b>	Nylon Fixed Arm for 4 leg models Cloud Gray	+\$0



### FRAME COLORS - TASK

CODE	DESCRIPTION	PRICE
<b>TSKB</b>	Black	+\$0
<b>TSKS</b>	Silver	+\$0

### PLASTIC COLORS

CODE	DESCRIPTION	PRICE
<b>P01</b>	Black Swan	+\$0
<b>P05</b>	White Whisper	+\$0
<b>P11</b>	Federal Blue	+\$0
<b>P12</b>	Crimson Red	+\$0
<b>P13</b>	Lemon Yellow	+\$0
<b>P14</b>	Dove Gray	+\$0
<b>P15</b>	Cloud Gray	+\$0
<b>P16</b>	Lagoon Blue	+\$0
<b>P17</b>	Apple Green	+\$0
<b>P18</b>	Tangerine Orange	+\$0
<b>P19</b>	Latte	+\$0
<b>P20</b>	Azure Blue	+\$0

### BASE OPTIONS

CODE	DESCRIPTION	PRICE
<b>BA11B</b>	27" Mid-Profile Nylon Base • Black	+\$0
<b>BA11D</b>	27" Mid-Profile Nylon Base • Dove Gray	+\$0
<b>BA12B</b>	27" Mid-Profile Aluminum Base • Black	+\$110
<b>BA12P</b>	27" Mid-Profile Aluminum Base • Polished	+\$110
<b>BA12S</b>	27" Mid-Profile Aluminum Base • Silver	+\$110

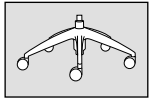
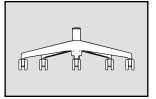

### STOOL OPTIONS

CODE	DESCRIPTION	PRICE
<b>CY30B</b>	8" Stool • (Seat Height: 22"-30") • Use for work surfaces up to 36"	+\$125
<b>CY36B</b>	10" Stool • (Seat Height: 25"-36") • Use for work surfaces up to 42"	+\$125



### CASTER OPTIONS

CODE	DESCRIPTION	PRICE
<b>C6</b>	Large Diameter Carpet Casters	+\$0
<b>C6S</b>	Large Diameter Hard Floor and Carpet Casters	+\$35
<b>C7</b>	Chrome-Accented Hard Floor and Carpet Casters	+\$35

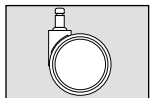
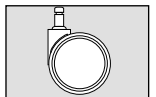
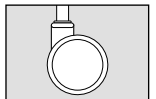



# Diddy

DAZZLE YOUR  
CONFERENCE SPACE

## MID-BACK

- Conference and guest seating
- Fixed wraparound arms
- Polished aluminum base standard
- Warranted to 300 lbs.

Webpage



GSA SIN # 33721

### MODEL / CONTROL

### ARMS MATERIAL

### DIMENSIONS

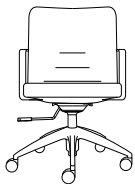

#### 2450 / B1

##### Mid-Back Basic Task

- 360° swivel
- Pneumatic cylinder height adjustment

	A	B/COM	C	D	E	F	G	L3/COL	L4	L5
A00	\$825	\$885	\$925	\$980	\$1,070	\$1,150	\$1,200	\$1,050	\$1,100	\$1,300
A24	\$960	\$1,020	\$1,060	\$1,115	\$1,205	\$1,285	\$1,335	\$1,185	\$1,235	\$1,435

WIDTH: 21.5  
DEPTH: 27.5  
HEIGHT: 31.5-36.0  
SEAT WIDTH: 19.0  
SEAT DEPTH: 18.0  
SEAT HEIGHT: 16.5-21.5  
BACK WIDTH: 18.0  
BACK HEIGHT: 16.5  
COM: 2.0 YD  
COL: 19.0 SQ FT  
WEIGHT: 31.0 LB



#### 2450 / S3

##### Mid-Back Swivel Tilt

- Upright lock
- Center knob tension adjustment
- 360° swivel
- Pneumatic cylinder height adjustment

	A	B/COM	C	D	E	F	G	L3/COL	L4	L5
A00	\$860	\$920	\$960	\$1,015	\$1,105	\$1,185	\$1,235	\$1,085	\$1,135	\$1,335
A24	\$995	\$1,055	\$1,095	\$1,150	\$1,240	\$1,320	\$1,370	\$1,220	\$1,270	\$1,470

WIDTH: 21.5  
DEPTH: 27.5  
HEIGHT: 31.50-36.0  
SEAT WIDTH: 19.0  
SEAT DEPTH: 18.0  
SEAT HEIGHT: 17.0-21.5  
BACK WIDTH: 18.0  
BACK HEIGHT: 16.5  
COM: 2.0 YD  
COL: 19.0 SQ FT  
WEIGHT: 31.0 LB

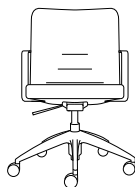

#### 2450 / R2

##### Mid-Back Rocking Tilt

- Polished aluminum 4-star base with glides or 5-star base with casters
- Rock left, right, front and back
- 360° swivel
- Pneumatic cylinder height adjustment

	A	B/COM	C	D	E	F	G	L3/COL	L4	L5
A00	\$930	\$990	\$1,030	\$1,085	\$1,175	\$1,255	\$1,305	\$1,155	\$1,205	\$1,405
A24	\$1,065	\$1,125	\$1,165	\$1,220	\$1,310	\$1,390	\$1,440	\$1,290	\$1,340	\$1,540

WIDTH: 21.5  
DEPTH: 27.5  
HEIGHT: 32.0-36.5  
SEAT WIDTH: 19.0  
SEAT DEPTH: 18.0  
SEAT HEIGHT: 17-21.5  
BACK WIDTH: 18.0  
BACK HEIGHT: 16.5  
COM: 2.0 YD  
COL: 19.0 SQ FT  
WEIGHT: 31.0 LB

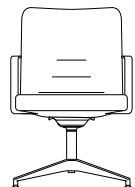

#### 2450 / GT

##### Mid-Back Guest

- Polished aluminum 4-star base with glides or 5-star base with casters
- 360° swivel
- Fixed height

	A	B/COM	C	D	E	F	G	L3/COL	L4	L5
A00	\$895	\$955	\$995	\$1,050	\$1,140	\$1,220	\$1,270	\$1,120	\$1,170	\$1,370
A24	\$1,030	\$1,090	\$1,130	\$1,185	\$1,275	\$1,355	\$1,405	\$1,255	\$1,305	\$1,505

WIDTH: 21.5  
DEPTH: 27.5  
HEIGHT: 33.0  
SEAT WIDTH: 19.0  
SEAT DEPTH: 18.0  
SEAT HEIGHT: 18.0  
BACK WIDTH: 18.0  
BACK HEIGHT: 16.5  
COM: 2.0 YD  
COL: 19.0 SQ FT  
WEIGHT: 31.0 LB



### ARM OPTIONS

CODE	DESCRIPTION	PRICE
<b>A24B</b>	Fixed Wraparound Arm • Black	+\$135
<b>A24C</b>	Fixed Wraparound Arm • Chrome	+\$135

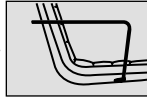

### BASE OPTIONS

CODE	DESCRIPTION	PRICE
<b>BA12B</b>	27" Mid-Profile Aluminum Base • Black	+\$0
<b>BA12P</b>	27" Mid-Profile Aluminum Base • Polished	+\$0
<b>BA12S</b>	27" Mid-Profile Aluminum Base • Silver • C7 Chrome-Accented Casters Standard with Polished Base	+\$0
<b>BA14P</b>	26" High Profile Aluminum • Polished	+\$0

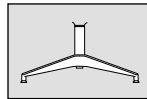
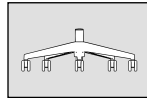

### CASTER OPTIONS

CODE	DESCRIPTION	PRICE
<b>C6</b>	Large Diameter Carpet Casters	+\$0
<b>C6S</b>	Large Diameter Hard Floor and Carpet Casters	+\$35
<b>C7</b>	Chrome-Accented Hard Floor and Carpet Casters • Standard with Polished Base	+\$0

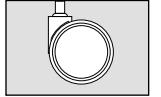
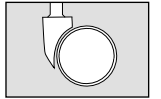
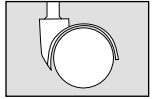



# Ellie

COMFORT MADE ELEGANT

## MID-BACK

- Synergy of simple form and functionality
- Combines lounge comfort with ergonomic function
- Mid-back or high-back options
- 5-star, 4-star or wire bases
- Multiple upholstery options
- Warranted to 300 lbs.

Webpage



GSA SIN # 33721 PENDING

### MODEL / CONTROL

### MATERIAL

### DIMENSIONS



#### 9360 / R4

##### Mid-Back 5-Star Base

- Black or gray 5-star base
- Two-tone upholstery option
- 360° swivel
- Pneumatic cylinder height adjustment
- Upright tilt lock
- Carpet casters standard and glides optional

A	B/COM	C	D	E	F	G			
\$1,555	\$1,615	\$1,660	\$1,713	\$1,815	\$1,905	\$1,995			

WIDTH: 27.0  
 DEPTH: 24.0  
 HEIGHT: 38.0  
 SEAT WIDTH: 17.0  
 SEAT DEPTH: 17.0  
 SEAT HEIGHT: 16.0-21.5  
 BACK WIDTH: 18.0  
 BACK HEIGHT: 19.5  
 COM: 2.0 YD  
 COL: N/A  
 WEIGHT: 27.0 LB



#### 9360 / R5

##### Mid-Back 4-Star Base

- Black, polished or white 4-star base
- Two-tone upholstery option
- 360° swivel
- Upright tilt lock
- Fixed seat height
- Carpet casters standard and glides optional

A	B/COM	C	D	E	F	G			
\$1,878	\$1,938	\$1,983	\$2,036	\$2,138	\$2,228	\$2,318			

WIDTH: 27.0  
 DEPTH: 24.0  
 HEIGHT: 38.0  
 SEAT WIDTH: 17.0  
 SEAT DEPTH: 17.0  
 SEAT HEIGHT: 18.5  
 BACK WIDTH: 18.0  
 BACK HEIGHT: 19.5  
 COM: 2.0 YD  
 COL: N/A  
 WEIGHT: 27.0 LB



#### 9360 / R5

##### Mid-Back Wire Base

- Black, Silver, Dover Gray or wire base
- Two-tone upholstery option
- 360° swivel
- Upright tilt lock
- Fixed seat height
- Glides standard

A	B/COM	C	D	E	F	G			
\$2,206	\$2,266	\$2,311	\$2,364	\$2,466	\$2,556	\$2,646			

WIDTH: 27.0  
 DEPTH: 24.0  
 HEIGHT: 38.0  
 SEAT WIDTH: 17.0  
 SEAT DEPTH: 17.0  
 SEAT HEIGHT: 18.5  
 BACK WIDTH: 18.0  
 BACK HEIGHT: 19.5  
 COM: 2.0 YD  
 COL: N/A  
 WEIGHT: 27.0 LB



### BASE OPTIONS

CODE	DESCRIPTION	PRICE	
<b>BA22B</b>	26" Mid-Profile 5-Star Nylon Base • Black	+\$0	
<b>BA22G</b>	26" Mid-Profile 5-Star Nylon Base • Gray	+\$0	
<b>BA23B</b>	29" High-Profile 4-Star Aluminum Base • Black	+\$0	
<b>BA23P</b>	29" High-Profile 4-Star Aluminum Base • Polished	+\$0	
<b>BA23W</b>	29" High-Profile 4-Star Aluminum Base • White	+\$0	
<b>BA24B</b>	31" Wire Base • Black	+\$0	
<b>BA24G</b>	31" Wire Base • Dover Gray	+\$0	
<b>BA24S</b>	31" Wire Base • Silver	+\$0	

### CASTER OPTIONS

CODE	DESCRIPTION	PRICE	
<b>C6</b>	Large Diameter Carpet Casters - Black	+\$0	
<b>C6S</b>	Large Diameter Hard Floor and Carpet Casters - Black	+\$35	
<b>C10G</b>	Decompression Carpet Casters - Gray	+\$0	
<b>C10GS</b>	Decompression Hard Floor and Carpet Casters - White and Gray	+\$35	

### ADDITIONAL OPTIONS

CODE	DESCRIPTION	PRICE	
<b>G22BF</b>	Stationary Glide - Felt • Black • (Optional with 5-Star or 4-Star Base)	+\$30	
<b>G22GF</b>	Stationary Glide - Felt • Gray • (Optional with 5-Star or 4-Star Base)	+\$30	
<b>G22BT</b>	Stationary Glide - Teflon • Black • (Optional with 5-Star or 4-Star Base)	+\$30	
<b>G22GT</b>	Stationary Glide - Teflon • Gray • (Optional with 5-Star or 4-Star Base)	+\$30	
<b>G23F</b>	Stationary Glide • Felt • (Standard with Wire Base)	+\$0	
<b>G23T</b>	Stationary Glide • Teflon • (Standard with Wire Base)	+\$0	
	Standard Single Upholstery	+\$0	
<b>TT</b>	Two-Tone Upholstery • *If the two upholstery selections are of different grades, the chair will price at the higher of the two grades.	+\$100*	
<b>AR</b>	Arm Rest Upholstery • Select a different textile for the arm rests. • Coated Textiles Available: From the 9to5 Seating Nautilus Card-Pauly, Ace, Vintner and Delta.	+\$100	



# Ellie

COMFORT MADE ELEGANT

## HIGH-BACK

- Synergy of simple form and functionality
- Combines lounge comfort with ergonomic function
- Mid-back or high-back options
- 5-star, 4-star or wire bases
- Multiple upholstery options
- Warranted to 300 lbs.

Webpage



GSA SIN # 33721 PENDING

### MODEL / CONTROL

### MATERIAL

### DIMENSIONS

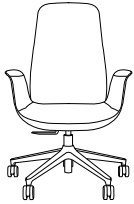

#### 9380 / R4

##### High-Back 5-Star Base

- Black or gray 5-star base
- Two-tone upholstery option
- 360° swivel
- Pneumatic cylinder height adjustment
- Upright tilt lock
- Carpet casters standard and glides optional

A	B/COM	C	D	E	F	G			
\$1,605	\$1,665	\$1,710	\$1,763	\$1,865	\$1,955	\$2,045			

WIDTH: 27.0  
 DEPTH: 24.0  
 HEIGHT: 42.5  
 SEAT WIDTH: 17.0  
 SEAT DEPTH: 17.0  
 SEAT HEIGHT: 16.0-21.5  
 BACK WIDTH: 18.0  
 BACK HEIGHT: 24.5  
 COM: 2.2 YD  
 COL: N/A  
 WEIGHT: 29.0 LB

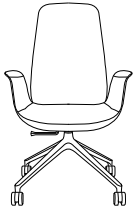

#### 9380 / R5

##### High-Back 4-Star Base

- Black, polished or white 4-star base
- Two-tone upholstery option
- 360° swivel
- Upright tilt lock
- Fixed seat height
- Carpet casters standard and glides optional

A	B/COM	C	D	E	F	G			
\$1,928	\$1,988	\$2,033	\$2,086	\$2,188	\$2,278	\$2,368			

WIDTH: 27.0  
 DEPTH: 24.0  
 HEIGHT: 42.5  
 SEAT WIDTH: 17.0  
 SEAT DEPTH: 17.0  
 SEAT HEIGHT: 18.5  
 BACK WIDTH: 18.0  
 BACK HEIGHT: 19.5  
 COM: 2.2 YD  
 COL: N/A  
 WEIGHT: 27.0 LB



#### 9380 / R5

##### High-Back Wire Base

- Black, Silver, Dover Gray or wire base
- Two-tone upholstery option
- 360° swivel
- Upright tilt lock
- Fixed seat height
- Glides standard

A	B/COM	C	D	E	F	G			
\$2,256	\$2,316	\$2,361	\$2,414	\$2,516	\$2,606	\$2,696			

WIDTH: 27.0  
 DEPTH: 24.0  
 HEIGHT: 42.5  
 SEAT WIDTH: 17.0  
 SEAT DEPTH: 17.0  
 SEAT HEIGHT: 18.5  
 BACK WIDTH: 18.0  
 BACK HEIGHT: 19.5  
 COM: 2.2 YD  
 COL: N/A  
 WEIGHT: 27.0 LB

# Ellie

## HIGH-BACK



GSA SIN # 33721 PENDING

### BASE OPTIONS

CODE	DESCRIPTION	PRICE	
<b>BA22B</b>	26" Mid-Profile 5-Star Nylon Base • Black	+\$0	
<b>BA22G</b>	26" Mid-Profile 5-Star Nylon Base • Gray	+\$0	
<b>BA23B</b>	29" High-Profile 4-Star Aluminum Base • Black	+\$0	
<b>BA23P</b>	29" High-Profile 4-Star Aluminum Base • Polished	+\$0	
<b>BA23W</b>	29" High-Profile 4-Star Aluminum Base • White	+\$0	
<b>BA24B</b>	31" Wire Base • Black	+\$0	
<b>BA24G</b>	31" Wire Base • Dover Gray	+\$0	
<b>BA24S</b>	31" Wire Base • Silver	+\$0	

### CASTER OPTIONS

CODE	DESCRIPTION	PRICE	
<b>C6</b>	Large Diameter Carpet Casters - Black	+\$0	
<b>C6S</b>	Large Diameter Hard Floor and Carpet Casters - Black	+\$35	
<b>C10G</b>	Decompression Carpet Casters - Gray	+\$0	
<b>C10GS</b>	Decompression Hard Floor and Carpet Casters - White and Gray	+\$35	

### ADDITIONAL OPTIONS

CODE	DESCRIPTION	PRICE	
<b>G22BF</b>	Stationary Glide - Felt • Black • (Optional with 5-Star or 4-Star Base)	+\$30	
<b>G22GF</b>	Stationary Glide - Felt • Gray • (Optional with 5-Star or 4-Star Base)	+\$30	
<b>G22BT</b>	Stationary Glide - Teflon • Black • (Optional with 5-Star or 4-Star Base)	+\$30	
<b>G22GT</b>	Stationary Glide - Teflon • Gray • (Optional with 5-Star or 4-Star Base)	+\$30	
<b>G23F</b>	Stationary Glide • Felt • (Standard with Wire Base)	+\$0	
<b>G23T</b>	Stationary Glide • Teflon • (Standard with Wire Base)	+\$0	
	Standard Single Upholstery	+\$0	
<b>TT</b>	Two-Tone Upholstery • *If the two upholstery selections are of different grades, the chair will price at the higher of the two grades.	+\$100*	
<b>AR</b>	Arm Rest Upholstery • Select a different textile for the arm rests. • Coated Textiles Available: From the 9to5 Seating Nautilus Card-Pauly, Ace, Vintner and Delta.	+\$100	



# HÅG Capisco

HUMAN-CENTERED DESIGN

## UPHOLSTERED BACK

- Task, stool, conference and executive seating
- HÅG in Balance® (balanced, flowing tilt function)
- Seat slider standard (not available on 8105)
- Height-adjustable back standard (not available on 8105)
- Suitable for all work surfaces of 28" and higher
- Multiple cylinder heights and ranges
- Optional coordinating foot ring
- Headrest available on 8106
- Warranted to 300 lbs.

Webpage



GSA SIN # 33721 PENDING

### MODEL / CONTROL

### MATERIAL

### DIMENSIONS

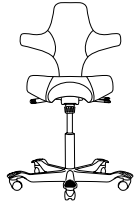

#### 8106 / R3

##### Saddle Seat Rocking Tilt

- Upholstered saddle-shaped seat
- Seat slider standard
- 2-position tilt lock
- Center knob tension adjustment
- 360° swivel
- Pneumatic seat height adjustment

A	B/COM	C	D	E	F	G	L3/COL	L4	L5
\$1,830	\$1,875	\$1,910	\$1,955	\$2,035	\$2,130	\$2,200	\$2,055	\$2,080	\$2,180

WIDTH: 29.0  
 DEPTH: 29.0  
 HEIGHT: CY23: 34.5-40.0  
 CY29: 37.5-44.0  
 CY37: 41.0-50.0  
 SEAT WIDTH: 18.5  
 SEAT DEPTH: 13.5-17.0  
 SEAT HEIGHT: CY23: 16.5-21.5  
 CY29: 19.0-26.0  
 CY37: 22.5-32.0  
 BACK WIDTH: 23.5  
 BACK HEIGHT: 16.0-19.5  
 COM: 1.25 YD  
 COL: 20.0 SQ FT  
 WEIGHT: 31.0 LB

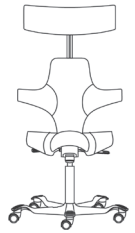

#### 8107 / R3

##### Headrest - HR, Saddle Seat Rocking Tilt

- Upholstered saddle-shaped seat
- Seat slider standard
- 2-position tilt lock
- Center knob tension adjustment
- 360° swivel
- Pneumatic seat height adjustment
- Adjustable headrest

A	B/COM	C	D	E	F	G	L3/COL	L4	L5
\$2,059	\$2,114	\$2,159	\$2,214	\$2,314	\$2,419	\$2,499	\$2,344	\$2,384	\$2,509

WIDTH: 29.0  
 DEPTH: 29.0  
 HEIGHT: CY23: 34.5-40.0  
 CY29: 37.5-44.0  
 CY37: 41.0-50.0  
 SEAT WIDTH: 18.5  
 SEAT DEPTH: 13.5-17.0  
 SEAT HEIGHT: CY23: 16.5-21.5  
 CY29: 19.0-26.0  
 CY37: 22.5-32.0  
 BACK WIDTH: 23.5  
 BACK HEIGHT: 16.0-19.5  
 COM: 1.25 YD  
 COL: 20.0 SQ FT  
 WEIGHT: 31.0 LB



#### 8105 / B4

##### Saddle Seat Stool

- Upholstered saddle-shaped seat
- 360° swivel
- Pneumatic seat height adjustment

A	B/COM	C	D	E	F	G	L3/COL	L4	L5
\$1,388	\$1,433	\$1,468	\$1,513	\$1,593	\$1,688	\$1,758	\$1,613	\$1,638	\$1,738

WIDTH: 29.0  
 DEPTH: 29.0  
 HEIGHT: CY23: 16.5-21.5  
 CY29: 19.0-26.0  
 CY37: 22.5-32.0  
 SEAT WIDTH: 18.5  
 SEAT DEPTH: 13.5-17.0  
 SEAT HEIGHT: CY23: 16.5-21.5  
 CY29: 19.0-26.0  
 CY37: 22.5-32.0  
 BACK WIDTH: N/A  
 BACK HEIGHT: N/A  
 COM: 0.65 YD  
 COL: 12 SQ FT  
 WEIGHT: 24.5 LB



#### 8126 / R3

##### Round Seat Rocking Tilt

- Upholstered round-shaped seat
- Seat slider standard
- 2-position tilt lock
- Center knob tension adjustment
- 360° swivel
- Pneumatic seat height adjustment

A	B/COM	C	D	E	F	G	L3/COL	L4	L5
\$1,867	\$1,912	\$1,947	\$1,992	\$2,072	\$2,167	\$2,237	\$2,092	\$2,117	\$2,217



WIDTH: 29.0  
 DEPTH: 29.0  
 HEIGHT: CY23: 34.5-40.0  
 CY29: 37.5-44.0  
 CY37: 41.0-50.0  
 SEAT WIDTH: 18.5  
 SEAT DEPTH: 13.5-17.0  
 SEAT HEIGHT: CY23: 16.5-21.5  
 CY29: 19.0-26.0  
 CY37: 22.5-32.0  
 BACK WIDTH: 23.43  
 BACK HEIGHT: 16.0-19.5  
 COM: 1.25 YD  
 COL: 20.0 SQ FT  
 WEIGHT: 31.0 LB

## UPHOLSTERED BACK

### FINISH COLORS

CODE	DESCRIPTION	PRICE
<b>TSKB</b>	Black	+\$0
<b>TSKS</b>	Silver	+\$0
<b>TSKW</b>	White	+\$0

### CYLINDER OPTIONS

CODE	DESCRIPTION	PRICE	
<b>CY23B</b>	Standard (Seat Height: 16.5-21.5) • Black	+\$0	
<b>CY23S</b>	Standard (Seat Height: 16.5-21.5) • Silver	+\$0	
<b>CY23W</b>	Standard (Seat Height: 16.5-21.5) • White	+\$0	
<b>CY29B</b>	Sit-to-Stand (Seat Height: 19.0-26.0) • Black	+\$0	
<b>CY29S</b>	Sit-to-Stand (Seat Height: 19.0-26.0) • Silver	+\$0	
<b>CY29W</b>	Sit-to-Stand (Seat Height: 19.0-26.0) • White	+\$0	
<b>CY37B</b>	Stool (Seat Height: 22.5-32.0) • Black	+\$0	
<b>CY37S</b>	Stool (Seat Height: 22.5-32.0) • Silver	+\$0	
<b>CY37W</b>	Stool (Seat Height: 22.5-32.0) • White	+\$0	

### BASE OPTIONS

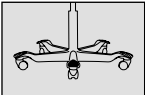
CODE	DESCRIPTION	PRICE	
<b>BA21B</b>	26" Low-Profile Aluminum Base with Curved/Arched Foot Plates • Black	+\$0	
<b>BA21S</b>	26" Low-Profile Aluminum Base with Curved/Arched Foot Plates • Silver	+\$0	
<b>BA21W</b>	26" Low-Profile Aluminum Base with Curved/Arched Foot Plates • White	+\$0	

### CASTER OPTIONS

CODE	DESCRIPTION	PRICE	
<b>C1S</b>	Hard Floor and Carpet Casters	+\$0	
<b>C2S</b>	Decompression Hard and Soft Carpet Casters	+\$0	

### ADDITIONAL OPTIONS

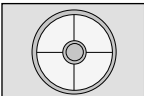
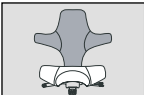
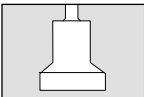
CODE	DESCRIPTION	PRICE	
<b>FR18B</b>	18" Foot Ring • Black	+\$165	
<b>FR18S</b>	18" Foot Ring • Silver	+\$165	
<b>FR18W</b>	18" Foot Ring • White	+\$165	
<b>TT</b>	Two-Tone Contrasting Upholstery (seat and back) • *If the two upholstery selections are of different grades, the chair will price at the higher of the two grades.	+\$0	
<b>G1</b>	Stationary Base Glide	+\$30	



# HÅG Capisco Puls

HUMAN-CENTERED DESIGN

## PLASTIC BACK

- Task, stool, conference and executive seating
- HÅG in Balance® (balanced, flowing tilt function)
- Seat slider standard (not available for 8001 & 8002)
- Height-adjustable back standard (not available for 8001 & 8002)
- Seat and back available in 3 colors
- Suitable for all work surfaces of 28" and higher
- Multiple cylinder heights and ranges
- Optional coordinating foot ring
- Warranted to 300 lbs.

Webpage



GSA SIN # 33721

### MODEL / CONTROL

### MATERIAL

### DIMENSIONS

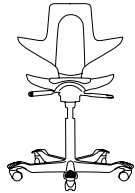

#### 8010 / R3

##### Saddle Seat Rocking Tilt

- Plastic saddle-shaped seat features upholstered pad
- Seat slider standard
- 2-position tilt lock
- Center knob tension adjustment
- 360° swivel
- Pneumatic seat height adjustment

A	B/COM	C	D	E	F	G	L3/COL	L4	L5
\$1,231	\$1,247	\$1,257	\$1,273	\$1,291	\$1,311	\$1,346	\$1,321	\$1,346	\$1,426

WIDTH:	29.0
DEPTH:	29.0
HEIGHT:	CY23: 34.5-40.0 CY29: 37.5-44.0 CY37: 41.0-50.0
SEAT WIDTH:	18.5
SEAT DEPTH:	13.5-17.0
SEAT HEIGHT:	CY23: 16.5-21.5 CY29: 19.0-26.0 CY37: 22.5-32.0
BACK WIDTH:	23.5
BACK HEIGHT:	16.0-19.5
COM:	0.6 YD
COL:	2.0 SQ FT
WEIGHT:	24.5 LB

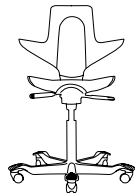

#### 8020 / R3

##### Saddle Seat, Rocking Tilt

- Plastic saddle-shaped seat features upholstered cushion
- Removable seat cushion
- Seat slider standard
- 2-position tilt lock
- Center knob tension adjustment
- 360° swivel
- Pneumatic seat height adjustment

A	B/COM	C	D	E	F	G			
\$1,339	\$1,363	\$1,378	\$1,402	\$1,429	\$1,459	\$1,499			

WIDTH:	29.0
DEPTH:	29.0
HEIGHT:	CY23: 34.5-40.0 CY29: 37.5-44.0 CY37: 41.0-50.0
SEAT WIDTH:	18.5
SEAT DEPTH:	13.5-17.0
SEAT HEIGHT:	CY23: 16.5-21.5 CY29: 19.0-26.0 CY37: 22.5-32.0
BACK WIDTH:	23.5
BACK HEIGHT:	16.0-19.5
COM:	0.75 YD
COL:	N/A
WEIGHT:	24.5 LB



#### 8001 / B4

##### Saddle Seat Stool

- Plastic saddle-shaped seat features upholstered pad
- Center knob tension adjustment
- 360° swivel
- Pneumatic seat height adjustment

A	B/COM	C	D	E	F	G	L3/COL	L4	L5
\$1,009	\$1,025	\$1,035	\$1,051	\$1,069	\$1,089	\$1,124	\$1,099	\$1,124	\$1,204

WIDTH:	29.0
DEPTH:	29.0
HEIGHT:	CY23: 16.5-21.5 CY29: 19.0-26.0 CY37: 22.5-32.0
SEAT WIDTH:	18.5
SEAT DEPTH:	13.5-17.0
SEAT HEIGHT:	CY23: 16.5-21.5 CY29: 19.0-26.0 CY37: 22.5-32.0
BACK WIDTH:	N/A
BACK HEIGHT:	N/A
COM:	0.15 YD
COL:	N/A
WEIGHT:	19.0 LB



#### 8002 / B4

##### Saddle Seat Stool

- Plastic saddle-shaped seat features upholstered cushion
- Removable seat cushion
- Center knob tension adjustment
- 360° swivel
- Pneumatic seat height adjustment

A	B/COM	C	D	E	F	G			
\$1,130	\$1,154	\$1,169	\$1,193	\$1,220	\$1,250	\$1,290			

WIDTH:	29.0
DEPTH:	29.0
HEIGHT:	CY23: 16.5-21.5 CY29: 19.0-26.0 CY37: 22.5-32.0
SEAT WIDTH:	18.5
SEAT DEPTH:	13.5-17.0
SEAT HEIGHT:	CY23: 16.5-21.5 CY29: 19.0-26.0 CY37: 22.5-32.0
BACK WIDTH:	N/A
BACK HEIGHT:	N/A
COM:	0.15 YD
COL:	N/A
WEIGHT:	19.0 LB

# HÅG Capisco Puls

Webpage



GSA SIN # 33721

## PLASTIC BACK

### FINISH COLORS

CODE	DESCRIPTION	PRICE
<b>TSKB</b>	Black	+\$0
<b>TSKS</b>	Silver	+\$0
<b>TSKW</b>	White	+\$0

### PLASTIC COLORS

CODE	DESCRIPTION	PRICE
<b>P40</b>	Black	+\$0
<b>P41</b>	Petroleum	+\$0
<b>P42</b>	Light Gray	+\$0

### CYLINDER OPTIONS

CODE	DESCRIPTION	PRICE
<b>CY23B</b>	Standard (Seat Height: 16.5-21.5) • Black	+\$0
<b>CY23S</b>	Standard (Seat Height: 16.5-21.5) • Silver	+\$0
<b>CY23W</b>	Standard (Seat Height: 16.5-21.5) • White	+\$0
<b>CY29B</b>	Sit-to-Stand (Seat Height: 19.0-26.0) • Black	+\$0
<b>CY29S</b>	Sit-to-Stand (Seat Height: 19.0-26.0) • Silver	+\$0
<b>CY29W</b>	Sit-to-Stand (Seat Height: 19.0-26.0) • White	+\$0
<b>CY37B</b>	Stool (Seat Height: 22.5-32.0) • Black	+\$0
<b>CY37S</b>	Stool (Seat Height: 22.5-32.0) • Silver	+\$0
<b>CY37W</b>	Stool (Seat Height: 22.5-32.0) • White	+\$0



### BASE OPTIONS

CODE	DESCRIPTION	PRICE
<b>BA21B</b>	26" Low-Profile Aluminum Base with Curved/Arched Foot Plates • Black	+\$0
<b>BA21S</b>	26" Low-Profile Aluminum Base with Curved/Arched Foot Plates • Silver	+\$0
<b>BA21W</b>	26" Low-Profile Aluminum Base with Curved/Arched Foot Plates • White	+\$0

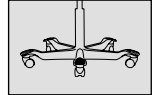

### CASTER OPTIONS

CODE	DESCRIPTION	PRICE
<b>C1S</b>	Hard Floor and Carpet Casters	+\$0
<b>C2S</b>	Decompression Hard and Soft Carpet Casters	+\$0

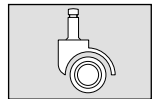
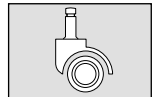

### ADDITIONAL OPTIONS

CODE	DESCRIPTION	PRICE
<b>FR18B</b>	18" Foot Ring • Black	+\$165
<b>FR18S</b>	18" Foot Ring • Silver	+\$165
<b>FR18W</b>	18" Foot Ring • White	+\$165
<b>G1</b>	Stationary Base Glide	+\$30

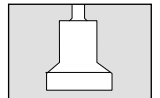
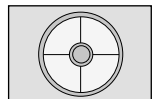



# HÅG Celi

SUSTAINABLE SEATING FOR DYNAMIC WORKSPACES

## STACKING

- Stacking, meeting, collaborative spaces
- Sturdy lightweight aluminum frame
- Armless or fixed arm
- Rocking motion of back and seat allow movement of legs and lower body
- All plastic, upholstered seat or fully upholstered models
- Mix or match plastic and aluminum colors
- Made with 76% recyclable materials
- Warranted to 300 lbs

Webpage



GSA SIN # 33721 PENDING

### MODEL

### ARMS MATERIAL

### DIMENSIONS

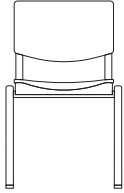

#### 9100 Plastic Back - PB & Plastic Seat - PS Stacking

- Rocking motion of back and seat allow movement of legs and lower body
- Stacks 15 high on floor armed or armless and on optional dolly
- Mix and match colors of arms and frame
- Non-marring glides standard for carpet that match frame color
- Felt glides for hard floor optional that match frame color

	P												
A00	\$568												
A61	\$693												

	ARMLESS	ARMS
WIDTH:	20.0	24.5
DEPTH:	20.5	20.5
HEIGHT:	33.0	33.0
SEAT WIDTH:	17.0	17.0
SEAT DEPTH:	16.5	16.5
SEAT HEIGHT:	18.5	18.5
BACK WIDTH:	17.0	17.0
BACK HEIGHT:	15.0	15.0
COM:	N/A	N/A
COL:	N/A	N/A
WEIGHT:	11.0 LB	13.0 LB

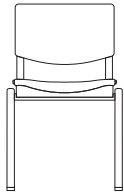

#### 9140 Plastic Back - PB & Upholstered Seat - US Stacking

- Rocking motion of back and seat allow movement of legs and lower body
- Stacks 12 high on floor armed or armless and on optional dolly
- Mix and match colors of arms and frame
- Non-marring glides standard for carpet that match frame color
- Felt glides for hard floor optional that match frame color

	A	B/COM	C	D	E	F	G	L3/COL	L4	L5
A00	\$642	\$687	\$722	\$747	\$772	\$822	\$867	\$792	\$842	\$912
A61	\$767	\$812	\$847	\$872	\$897	\$947	\$992	\$917	\$967	\$1,037

	ARMLESS	ARMS
WIDTH:	20.0	24.5
DEPTH:	20.5	20.5
HEIGHT:	33.0	33.0
SEAT WIDTH:	17.0	17
SEAT DEPTH:	16.5	16.5
SEAT HEIGHT:	18.5	18.5
BACK WIDTH:	17.0	17
BACK HEIGHT:	15.0	15
COM:	0.5	0.5
COL:	1.92	1.92
WEIGHT:	11.5 LB	13 LB

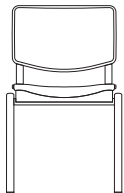

#### 9160 Upholstered Back - UB & Upholstered Seat - US Stacking

- Rocking motion of back and seat allow movement of legs and lower body
- Stacks 12 high on floor armed or armless and on optional dolly
- Mix and match colors of arms and frame
- Non-marring glides standard for carpet that match frame color
- Felt glides for hard floor optional that match frame color

	A	B/COM	C	D	E	F	G	L3/COL	L4	L5
A00	\$768	\$848	\$888	\$918	\$958	\$1,063	\$1,118	\$1,038	\$1,088	\$1,243
A61	\$893	\$973	\$1,013	\$1,043	\$1,083	\$1,188	\$1,243	\$1,163	\$1,213	\$1,368

	ARMLESS	ARMS
WIDTH:	20.0	24.5
DEPTH:	20.5	20.5
HEIGHT:	33.0	33.0
SEAT WIDTH:	17.0	17.0
SEAT DEPTH:	16.5	16.5
SEAT HEIGHT:	18.5	18.5
BACK WIDTH:	17.0	17.0
BACK HEIGHT:	15.0	15.0
COM:	0.8	0.8
COL:	3.36	3.36
WEIGHT:	11.5 LB	13.0 LB



### ARM OPTION

CODE	DESCRIPTION	PRICE
<b>A61B</b>	Aluminum Fixed arm • Black	+\$125
<b>A61RW</b>	Aluminum Fixed arm • Raw	+\$125
<b>A61BB</b>	Aluminum Fixed arm • Blueberry	+\$125
<b>A61R</b>	Aluminum Fixed arm • Blush Rose	+\$125
<b>A61S</b>	Aluminum Fixed arm • Silver (extended lead time)	+\$125

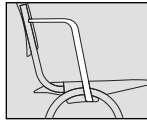

### FRAME COLORS

CODE	DESCRIPTION	PRICE
<b>BF</b>	Black	+\$0
<b>RWF</b>	Raw	+\$0
<b>BBF</b>	Blueberry	+\$0
<b>RF</b>	Blush Rose	+\$0
<b>SF</b>	Silver (extended lead time)	+\$0

### PLASTIC COLORS

CODE	DESCRIPTION	PRICE
<b>P40</b>	Black	+\$0
<b>P45</b>	Crowberry	+\$40
<b>P48</b>	Chestnut	+\$40
<b>P49</b>	Slate	+\$0
<b>AW</b>	Wood (extended lead time)	+\$0

### ADDITIONAL OPTIONS

CODE	DESCRIPTION	PRICE
<b>G24B</b>	Nylon Glide For Carpet Or Soft Surface Floors • Black	+\$0
<b>G24S</b>	Nylon Glide For Carpet Or Soft Surface Floors • Silver	+\$0
<b>G24BB</b>	Nylon Glide For Carpet Or Soft Surface Floors • Blueberry	+\$0
<b>G24R</b>	Nylon Glide For Carpet Or Soft Surface Floors • Blush Rose	+\$0
<b>G24FBF</b>	Felt Glide For Hard Surface Floors • Black	+\$20
<b>G24FSF</b>	Felt Glide For Hard Surface Floors • Silver	+\$20
<b>G24FBBF</b>	Felt Glide For Hard Surface Floors • Blueberry	+\$20
<b>G24FRF</b>	Felt Glide For Hard Surface Floors • Blush Rose	+\$20

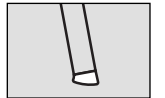
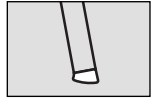

### ACCESSORIES

CODE	DESCRIPTION	PRICE
<b>GC10</b>	Ganging Clip • 1 Per Set • Armless-To-Armless • Not Available For Armed Models.	+\$30
<b>DL6</b>	Stacking Dolly • Stacks up to 12 High	+\$699

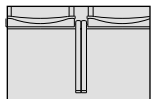



# HÅG Tion

HARMONIZING WORK AND WELLNESS

## LIGHT TASK

- Light task, conference and collaborative seating
- Designed for flexibility and to fit in any workspace
- Multiple plastic, aluminum colors and finishes
- Made with 75% recycled and renewable materials
- Multiple cylinder and seat height ranges
- Optional coordinating foot ring
- Warranted to 300 lbs

Webpage



GSA SIN # 33721 PENDING

### MODEL / CONTROL

### ARMS MATERIAL

### DIMENSIONS



#### 2100 / R6

Plastic Back - PB & Plastic Seat - PS

- Upright tilt lock; 360 swivel
- Pneumatic cylinder height adjustment

	P											
A00	\$696											
A60	\$826											

WIDTH: 24.0  
 DEPTH: 24.5  
 HEIGHT: 26.0-31.5  
 SEAT WIDTH: 18.0  
 SEAT DEPTH: 17.0  
 SEAT HEIGHT: 16.0-21.5  
 BACK WIDTH: 18.5  
 BACK HEIGHT: 10.0  
 COM: N/A  
 COL: N/A  
 WEIGHT: 24.0 LB



#### 2140 / R6

Plastic Back - PB & Upholstered Seat - US

- Upright tilt lock; 360 swivel
- Pneumatic cylinder height adjustment

	A	B/COM	C	D	E	F	G	L3/COL	L4	L5
A00	\$821	\$859	\$896	\$911	\$976	\$1,021	\$1,056	\$971	\$1,021	\$1,091
A60	\$951	\$989	\$1,026	\$1,041	\$1,106	\$1,151	\$1,186	\$1,101	\$1,151	\$1,221

WIDTH: 24.0  
 DEPTH: 24.5  
 HEIGHT: 26.0-31.5  
 SEAT WIDTH: 18.0  
 SEAT DEPTH: 17.0  
 SEAT HEIGHT: 16.0-21.5  
 BACK WIDTH: 18.5  
 BACK HEIGHT: 10.0  
 COM: 0.7 YD  
 COL: 2.5 SQ FT  
 WEIGHT: 24.0 LB



#### 2160 / R6

Upholstered Back - UB & Upholstered Seat - US

- Upright tilt lock; 360 swivel
- Pneumatic cylinder height adjustment

	A	B/COM	C	D	E	F	G	L3/COL	L4	L5
A00	\$901	\$963	\$1,009	\$1,044	\$1,109	\$1,246	\$1,351	\$1,181	\$1,231	\$1,401
A60	\$1,031	\$1,093	\$1,139	\$1,174	\$1,239	\$1,376	\$1,481	\$1,311	\$1,361	\$1,531

WIDTH: 24.0  
 DEPTH: 24.5  
 HEIGHT: 26.0-31.5  
 SEAT WIDTH: 18.0  
 SEAT DEPTH: 17.0  
 SEAT HEIGHT: 16.0-21.5  
 BACK WIDTH: 18.5  
 BACK HEIGHT: 10.0  
 COM: 1.7 YD  
 COL: 4.82 YD  
 WEIGHT: 24.0 LB



#### 2200 / R6

Wood Back - WB and Wood Seat - WS

- Upright tilt lock; 360 swivel
- Pneumatic cylinder height adjustment
- Ash wood with clear stain

	W									
A00	\$1,389									
A60	\$1,519									

WIDTH: 24.0  
 DEPTH: 24.5  
 HEIGHT: 26.0-31.5  
 SEAT WIDTH: 18.0  
 SEAT DEPTH: 17.0  
 SEAT HEIGHT: 16.0-21.5  
 BACK WIDTH: 18.5  
 BACK HEIGHT: 10.0  
 COM: N/A  
 COL: N/A  
 WEIGHT: 30.5 LB

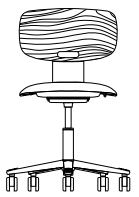

#### 2240 / R6

Wood Back - WB & Upholstered Seat - US

- Upright tilt lock; 360 swivel
- Pneumatic cylinder height adjustment
- Ash wood with clear stain

	A	B	C	D	E	F	G	L3/COL	L4	L5
A00	\$1,231	\$1,269	\$1,306	\$1,321	\$1,386	\$1,431	\$1,466	\$1,381	\$1,431	\$1,501
A60	\$1,361	\$1,399	\$1,436	\$1,451	\$1,516	\$1,561	\$1,596	\$1,511	\$1,561	\$1,631

WIDTH: 24.0  
 DEPTH: 24.5  
 HEIGHT: 26.0-31.5  
 SEAT WIDTH: 18.0  
 SEAT DEPTH: 17.0  
 SEAT HEIGHT: 16.0-21.5  
 BACK WIDTH: 18.5  
 BACK HEIGHT: 10.0  
 COM: 0.6 YD  
 COL: 2.5 SQ FT  
 WEIGHT: 30.5 LB

# HÅG Tion

## LIGHT TASK

Webpage



GSA SIN # 33721 PENDING

### ARM OPTIONS

CODE	DESCRIPTION	PRICE
<b>A60B</b>	Aluminum Fixed Arm • Black	+\$130
<b>A60M</b>	Aluminum Fixed Arm • Moss	+\$130
<b>A60W</b>	Aluminum Fixed Arm • White	+\$130
<b>A60T</b>	Aluminum Fixed Arm • Tumbled	+\$175
<b>A60S</b>	Aluminum Fixed Arm • Silver (extended lead time)	+\$130
<b>A60R</b>	Aluminum Fixed Arm • Blush Rose (extended lead time)	+\$130
<b>A60P</b>	Aluminum Fixed Arm • Polished (extended lead time)	+\$230

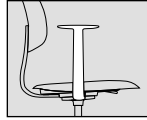

### CYLINDER OPTIONS

CODE	DESCRIPTION	PRICE
<b>CY23B</b>	Standard Height Cylinder Seat Height: 16.5"-21.5", Black	+\$0
<b>CY23M</b>	Standard Height Cylinder Seat Height: 16.5"-21.5", Moss	+\$0
<b>CY23S</b>	Standard Height Cylinder Seat Height: 16.5"-21.5", Silver	+\$0
<b>CY23W</b>	Standard Height Cylinder Seat Height: 16.5"-21.5", White	+\$0
<b>CY23R</b>	Standard Height Cylinder Seat Height: 16.5"-21.5", Blush Rose (extended lead time)	+\$0
<b>CY29B</b>	Sit to Stand Height Cylinder Seat Height: 19"-26", Black	+\$0
<b>CY29M</b>	Sit to Stand Height Cylinder Seat Height: 19"-26", Moss	+\$0
<b>CY29S</b>	Sit to Stand Height Cylinder Seat Height: 19"-26", Silver	+\$0
<b>CY29W</b>	Sit to Stand Height Cylinder Seat Height: 19"-26", White	+\$0
<b>CY29R</b>	Sit to Stand Height Cylinder Seat Height: 19"-26", Blush Rose (extended lead time)	+\$0



### BACK STEM OPTIONS

CODE	DESCRIPTION	PRICE
<b>BF</b>	Aluminum Back Stem • Black	+\$0
<b>MF</b>	Aluminum Back Stem • Moss	+\$0
<b>TF</b>	Aluminum Back Stem • Tumbled	+\$15
<b>WF</b>	Aluminum Back Stem • White	+\$0
<b>SF</b>	Aluminum Back Stem • Silver (extended lead time)	+\$0
<b>RF</b>	Aluminum Back Stem • Blush Rose (extended lead time)	+\$0
<b>PF</b>	Aluminum Back Stem • Polished (extended lead time)	+\$65

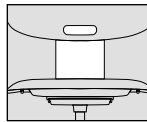

### BASE OPTIONS

CODE	DESCRIPTION	PRICE
<b>BA27B</b>	24.5" Low Profile Aluminum Base • Black	+\$0
<b>BA27M</b>	24.5" Low Profile Aluminum Base • Moss	+\$0
<b>BA27T</b>	24.5" Low Profile Aluminum Base • Tumbled	+\$50
<b>BA27W</b>	24.5" Low Profile Aluminum Base • White	+\$0
<b>BA27S</b>	24.5" Low Profile Aluminum Base • Silver (extended lead time)	+\$0
<b>BA27R</b>	24.5" Low Profile Aluminum Base • Blush Rose (extended lead time)	+\$0
<b>BA27P</b>	24.5" Low Profile Aluminum Base • Polished (extended lead time)	+\$125

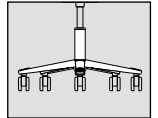

### PLASTIC COLORS

CODE	DESCRIPTION	PRICE
<b>P40</b>	Black	+\$0
<b>P43</b>	Harvest	+\$0
<b>P44</b>	Moss	+\$0
<b>P45</b>	Crowberry	+\$0
<b>P46</b>	Mist (extended lead time)	+\$0
<b>P47</b>	Blush Rose (extended lead time)	+\$0
<b>P48</b>	Chestnut (extended lead time)	+\$0

### ADDITIONAL OPTIONS

CODE	DESCRIPTION	PRICE
<b>FR18B</b>	18" Foot Ring • Black	+\$165
<b>FR18S</b>	18" Foot Ring • Silver	+\$165
<b>FR18W</b>	18" Foot Ring • White	+\$165
<b>TT</b>	Two Tone Contrasting Upholstery (seat and back) • If the two upholstery selections are of different grades, the chair will price at the higher of the two grades.	+\$50

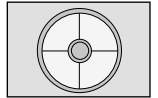

### CASTER OPTIONS

CODE	DESCRIPTION	PRICE
<b>C10BS</b>	Decompression Hard Floor and Carpet Casters - Black	+\$0

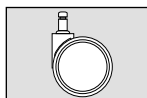



# Jax

RESHAPING COMFORT

## HIGH-BACK LOUNGE

- Lounge, side and guest seating
- Modern, angular design
- Warranted to 300 lbs.

Webpage



GSA SIN # 33721

### MODEL / CHAIR TYPE

### MATERIAL

### DIMENSIONS

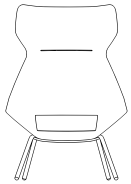

**9206**  
**Wing-Back Lounge Chair**  
**4 Metal Legs**

- Black or silver 4-leg base
- Dome glides standard

A	B/COM	C	D	E	F	G
\$2,113	\$2,198	\$2,263	\$2,343	\$2,488	\$2,628	\$2,743

WIDTH: 31.0  
DEPTH: 30.0  
HEIGHT: 45.5  
SEAT WIDTH: 16.0  
SEAT DEPTH: 18.5  
SEAT HEIGHT: 17.0  
BACK WIDTH: 23.5  
BACK HEIGHT: 32.0  
COM: 3.0 YD  
COL: 57.0 SQ FT  
WEIGHT: 48.0 LB

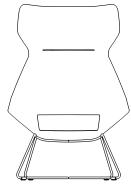

**9206**  
**Wing-Back Lounge Chair**  
**Wire Rod Base**

- Black or silver wire rod base
- Optional glides available- G16 & G17

A	B/COM	C	D	E	F	G
\$2,239	\$2,324	\$2,389	\$2,469	\$2,614	\$2,754	\$2,869

WIDTH: 31.0  
DEPTH: 30.0  
HEIGHT: 45.5  
SEAT WIDTH: 16.0  
SEAT DEPTH: 18.5  
SEAT HEIGHT: 17.0  
BACK WIDTH: 23.5  
BACK HEIGHT: 32.0  
COM: 3.0 YD  
COL: 57.0 SQ FT  
WEIGHT: 48.0 LB

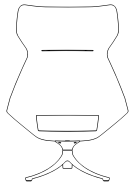

**9206**  
**Wing-Back Lounge Chair**  
**Swivel Base**

- Polished and black aluminum swivel base
- Adjustable nylon glides standard
- Optional auto-return cylinder

A	B/COM	C	D	E	F	G
\$2,289	\$2,374	\$2,439	\$2,519	\$2,664	\$2,804	\$2,919

WIDTH: 31.0  
DEPTH: 30.0  
HEIGHT: 45.5  
SEAT WIDTH: 16.0  
SEAT DEPTH: 18.5  
SEAT HEIGHT: 17.0  
BACK WIDTH: 23.5  
BACK HEIGHT: 32.0  
COM: 3.0 YD  
COL: 57.0 SQ FT  
WEIGHT: 52.0 LB

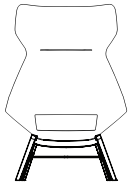

**9206**  
**Wing-Back Lounge Chair**  
**4 Wood Legs**

- Maple or walnut finish legs
- Two-tone upholstery available
- Adjustable nylon glides standard

A	B/COM	C	D	E	F	G
\$2,439	\$2,524	\$2,589	\$2,669	\$2,814	\$2,954	\$3,069

WIDTH: 31.0  
DEPTH: 30.0  
HEIGHT: 45.5  
SEAT WIDTH: 16.0  
SEAT DEPTH: 18.5  
SEAT HEIGHT: 17.0  
BACK WIDTH: 23.5  
BACK HEIGHT: 32.0  
COM: 3.0 YD  
COL: 57.0 SQ FT  
WEIGHT: 48.0 LB



### BASE OPTIONS

CODE	DESCRIPTION	PRICE	
<b>4LGB</b>	4 Leg • Black	+\$0	
<b>4LGS</b>	4 Leg • Silver	+\$0	
<b>BA20P</b>	Aluminum Swivel Base Polished	+\$0	
<b>BA20B</b>	Aluminum Swivel Base Black	+\$0	
<b>CY9N</b>	Free Swivel	+\$0	
<b>CY9NA</b>	Auto Return	+\$50	
<b>MPL</b>	Wood Leg • Maple	+\$0	
<b>WAL</b>	Wood Leg • Walnut	+\$0	
<b>WIRB</b>	Wire Rod • Black	+\$0	
<b>WIRS</b>	Wire Rod • Silver	+\$0	

### ADDITIONAL OPTIONS

CODE	DESCRIPTION	PRICE	
<b>G18</b>	Dome Glide	+\$0	
<b>G8</b>	Swivel Steel Glide • 4 per Set	+\$20	
<b>G9</b>	Swivel Nylon Glide • 4 per Set	+\$20	
<b>G10</b>	Swivel Felt Glide • 4 per Set	+\$20	
<b>G16</b>	Sled Base Clear Plastic Glide • 4 per seat	+\$15	
<b>G17</b>	Sled Base Clear Plastic Glide with Felt • 4 per seat	+\$25	
<b>TT</b>	Two Tone Contrasting Upholstery (seat and back) *If the two upholstery selections are of different grades, the chair will price at the higher of the two grades.	+\$100*	



# Jax

RESHAPING COMFORT

## MID-BACK LOUNGE

- Lounge, side and stool seating
- Modular, angular design
- Warranted to 300 lbs.

Webpage



GSA SIN # 33721

### MODEL / CHAIR TYPE

### MATERIAL

### DIMENSIONS



**9201**  
Mid-Back Lounge Chair  
4 Metal Legs

- Black or silver 4-leg base
- Dome glides standard

A	B/COM	C	D	E	F	G	L3/COL	L4
\$1,956	\$2,036	\$2,106	\$2,181	\$2,321	\$2,471	\$2,576	\$2,256	\$2,401

WIDTH: 31.0  
DEPTH: 28.0  
HEIGHT: 32.5  
SEAT WIDTH: 16.0  
SEAT DEPTH: 18.5  
SEAT HEIGHT: 17.0  
BACK WIDTH: 23.5  
BACK HEIGHT: 20.0  
COM: 2.4 YD  
COL: 47.0 SQ FT  
WEIGHT: 32.0 LB



**9201**  
Mid-Back Lounge Chair  
Wire Rod Base

- Black or silver wire rod base
- Optional glides available-G16 & G17

A	B/COM	C	D	E	F	G	L3/COL	L4
\$2,050	\$2,130	\$2,200	\$2,275	\$2,415	\$2,565	\$2,670	\$2,350	\$2,495

WIDTH: 31.0  
DEPTH: 28.0  
HEIGHT: 32.5  
SEAT WIDTH: 16.0  
SEAT DEPTH: 18.5  
SEAT HEIGHT: 17.0  
BACK WIDTH: 23.5  
BACK HEIGHT: 20.0  
COM: 2.4 YD  
COL: 47.0 SQ FT  
WEIGHT: 32.0 LB



**9201**  
Mid-Back Lounge Chair  
Swivel Base

- Polished and black aluminum swivel base
- Adjustable nylon glides standard
- Optional auto-return cylinder

A	B/COM	C	D	E	F	G	L3/COL	L4
\$2,135	\$2,215	\$2,285	\$2,360	\$2,500	\$2,650	\$2,755	\$2,435	\$2,580

WIDTH: 31.0  
DEPTH: 28.0  
HEIGHT: 32.5  
SEAT WIDTH: 16.0  
SEAT DEPTH: 18.5  
SEAT HEIGHT: 17.0  
BACK WIDTH: 23.5  
BACK HEIGHT: 20.0  
COM: 2.4 YD  
COL: 47.0 SQ FT  
WEIGHT: 34.0 LB

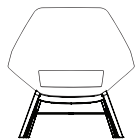

**9201**  
Mid-Back Lounge Chair  
Wood Base

- Maple or walnut finish legs
- Two-tone upholstery available
- Adjustable nylon glides standard

A	B/COM	C	D	E	F	G	L3/COL	L4
\$2,297	\$2,377	\$2,447	\$2,522	\$2,662	\$2,812	\$2,917	\$2,597	\$2,742

WIDTH: 31.0  
DEPTH: 28.0  
HEIGHT: 32.5  
SEAT WIDTH: 16.0  
SEAT DEPTH: 18.5  
SEAT HEIGHT: 17.0  
BACK WIDTH: 23.5  
BACK HEIGHT: 20.0  
COM: 2.4 YD  
COL: 47.0 SQ FT  
WEIGHT: 30.0 LB



### BASE OPTIONS

CODE	DESCRIPTION	PRICE	
<b>4LGB</b>	4 Leg • Black	+\$0	
<b>4LGS</b>	4 Leg • Silver	+\$0	
<b>BA20P</b>	Aluminum Swivel Base Polished	+\$0	
<b>BA20B</b>	Aluminum Swivel Base Black	+\$0	
<b>CY9N</b>	Free Swivel	+\$0	
<b>CY9NA</b>	Auto Return	+\$50	
<b>MPL</b>	Wood Leg • Maple	+\$0	
<b>WAL</b>	Wood Leg • Walnut	+\$0	
<b>WIRB</b>	Wire Rod • Black	+\$0	
<b>WIRS</b>	Wire Rod • Silver	+\$0	

### ADDITIONAL OPTIONS

CODE	DESCRIPTION	PRICE	
<b>G18</b>	Dome Glide	+\$0	
<b>G8</b>	Swivel Steel Glide • 4 per Set	+\$20	
<b>G9</b>	Swivel Nylon Glide • 4 per Set	+\$20	
<b>G10</b>	Swivel Felt Glide • 4 per Set	+\$20	
<b>G16</b>	Sled Base Clear Plastic Glide • 4 per seat	+\$15	
<b>G17</b>	Sled Base Clear Plastic Glide with Felt • 4 per seat	+\$25	
<b>TT</b>	Two Tone Contrasting Upholstery (seat and back) *If the two upholstery selections are of different grades, the chair will price at the higher of the two grades.	+\$100*	



# Jax

RESHAPING COMFORT

## SIDE

- Lounge, side and stool seating
- Classic, sophisticated design
- Warranted to 300 lbs.

Webpage



GSA SIN # 33721

### MODEL / CHAIR TYPE

### MATERIAL

### DIMENSIONS



#### 9204

##### Side Chair 4 Metal Legs

- Black or silver 4-leg base
- Dome glides standard

A	B/COM	C	D	E	F	G	L3/COL	L4	L5
\$1,686	\$1,761	\$1,816	\$1,876	\$2,011	\$2,111	\$2,236	\$1,936	\$2,111	\$2,436

WIDTH: 24.5  
DEPTH: 24.0  
HEIGHT: 31.5  
SEAT WIDTH: 19.0  
SEAT DEPTH: 18.0  
SEAT HEIGHT: 18.0  
BACK WIDTH: 20.0  
BACK HEIGHT: 15.5  
COM: 2.0 YD  
COL: 37.0 SQ FT  
WEIGHT: 27.0 LB



#### 9204

##### Side Chair Wire Rod Base

- Black or silver wire rod base
- Optional glides available-G16 & G17

A	B/COM	C	D	E	F	G	L3/COL	L4	L5
\$1,736	\$1,811	\$1,866	\$1,926	\$2,061	\$2,161	\$2,286	\$1,986	\$2,161	\$2,486

WIDTH: 24.5  
DEPTH: 24.0  
HEIGHT: 31.5  
SEAT WIDTH: 19.0  
SEAT DEPTH: 18.0  
SEAT HEIGHT: 18.0  
BACK WIDTH: 20.0  
BACK HEIGHT: 15.5  
COM: 2.0 YD  
COL: 37.0 SQ FT  
WEIGHT: 27.0 LB

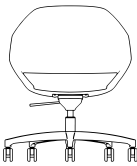

#### 9204

##### Side Chair 5-Star Base

- Polished 5-star base standard
- Mechanism allows front-to-back and side-to-side rocking
- 360° swivel
- Pneumatic cylinder height adjustment

A	B/COM	C	D	E	F	G	L3/COL	L4	L5
\$1,820	\$1,895	\$1,950	\$2,010	\$2,145	\$2,245	\$2,370	\$2,070	\$2,245	\$2,570

WIDTH: 24.5  
DEPTH: 24.0  
HEIGHT: 31.5  
SEAT WIDTH: 19.0  
SEAT DEPTH: 18.0  
SEAT HEIGHT: 18.0  
BACK WIDTH: 20.0  
BACK HEIGHT: 15.5  
COM: 2.0 YD  
COL: 37.0 SQ FT  
WEIGHT: 33.5 LB



#### 9204

##### Side Chair Wood Base

- Maple or walnut finish
- Black or Silver frame
- Two-tone upholstery available
- No glides available

A	B/COM	C	D	E	F	G	L3/COL	L4	L5
\$1,865	\$1,940	\$1,995	\$2,055	\$2,190	\$2,290	\$2,415	\$2,115	\$2,290	\$2,615

WIDTH: 24.5  
DEPTH: 24.0  
HEIGHT: 31.5-36.0  
SEAT WIDTH: 19.0  
SEAT DEPTH: 18.0  
SEAT HEIGHT: 18.0-22.5  
BACK WIDTH: 20.0  
BACK HEIGHT: 15.5  
COM: 2.0 YD  
COL: 37.0 SQ FT  
WEIGHT: 33.5 LB

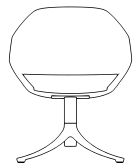

#### 9204

##### Side Chair Swivel Base

- Polished and black aluminum swivel base
- Adjustable nylon glides standard
- Optional auto-return cylinder

A	B/COM	C	D	E	F	G	L3/COL	L4	L5
\$1,860	\$1,935	\$1,990	\$2,050	\$2,185	\$2,285	\$2,410	\$2,110	\$2,285	\$2,610

WIDTH: 24.5  
DEPTH: 24.0  
HEIGHT: 31.5  
SEAT WIDTH: 19.0  
SEAT DEPTH: 18.0  
SEAT HEIGHT: 18.0  
BACK WIDTH: 20.0  
BACK HEIGHT: 15.5  
COM: 2.0 YD  
COL: 37.0 SQ FT  
WEIGHT: 27 LB



#### 9204

##### Side Chair Wood Rocker



- Maple or walnut finish
- Black or Silver frame
- Two-tone upholstery available
- No glides available

A	B/COM	C	D	E	F	G	L3/COL	L4	L5
\$1,905	\$1,980	\$2,035	\$2,095	\$2,230	\$2,330	\$2,455	\$2,155	\$2,330	\$2,655

WIDTH: 24.5  
DEPTH: 24.0  
HEIGHT: 33.5  
SEAT WIDTH: 19.0  
SEAT DEPTH: 18.0  
SEAT HEIGHT: 18.0  
BACK WIDTH: 20.0  
BACK HEIGHT: 15.5  
COM: 2.0 YD  
COL: 37.0 SQ FT  
WEIGHT: 27 LB

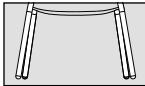
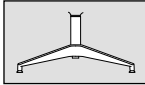
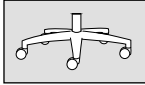
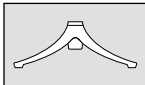

### BASE OPTIONS

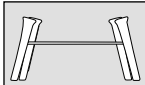
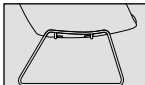
CODE	DESCRIPTION	PRICE	
<b>4LGB</b>	4 Leg • Black	+\$0	
<b>4LGS</b>	4 Leg • Silver	+\$0	
<b>BA14P</b>	26" High Profile Aluminum Base • Polished	+\$0	
<b>BA16B</b>	27" Mid-Profile Base • Black	+\$0	
<b>BA16P</b>	27" Mid-Profile Base • Polished	+\$0	
<b>BA20P</b>	Aluminum Swivel Base • Polished	+\$0	
<b>BA20B</b>	Aluminum Swivel Base • Black	+\$0	
<b>CY9N</b>	Free Swivel	+\$0	
<b>CY9NA</b>	Auto Return	+\$50	
<b>RKRMB</b>	Wood Rocker Frame, Maple with Black frame	+\$0	
<b>RKRMS</b>	Wood Rocker Frame, Maple with Silver frame	+\$0	
<b>RKRWB</b>	Wood Rocker Frame, Walnut with Black frame	+\$0	
<b>RKRWS</b>	Wood Rocker Frame, Walnut with Silver Frame	+\$0	
<b>MPL</b>	Wood Leg • Maple	+\$0	
<b>WAL</b>	Wood Leg • Walnut	+\$0	
<b>WIRB</b>	Wire Rod • Black	+\$0	
<b>WIRS</b>	Wire Rod • Silver	+\$0	

### ADDITIONAL OPTIONS

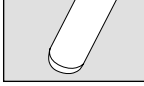
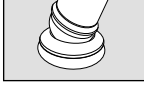
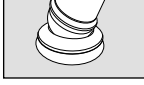
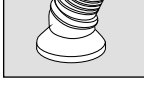
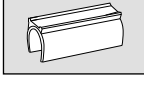
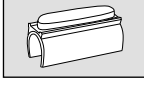
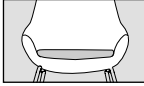
CODE	DESCRIPTION	PRICE	
<b>G18</b>	Dome Glide	+\$0	
<b>G8</b>	Swivel Steel Glide • 4 per Set	+\$20	
<b>G9</b>	Swivel Nylon Glide • 4 per Set	+\$20	
<b>G10</b>	Swivel Felt Glide • 4 per Set	+\$20	
<b>G16</b>	Sled Base Clear Plastic Glide • 4 per seat	+\$15	
<b>G17</b>	Sled Base Clear Plastic Glide with Felt • 4 per seat	+\$25	
<b>TT</b>	Two Tone Contrasting Upholstery (seat and back) *If the two upholstery selections are of different grades, the chair will price at the higher of the two grades.	+\$100*	

### CASTER OPTIONS

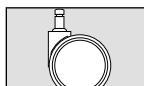
CODE	DESCRIPTION	PRICE	
<b>C6</b>	Large Diameter Carpet Casters	+\$0	
<b>C7</b>	Chrome-Accented Hard Floor and Carpet Casters	+\$0	



# Kelley

NOTHING STACKS UP  
TO KELLEY

## STACKING

- High-density stacking side, guest and stool seating
- All plastic or upholstered seat
- Pull handle for easy mobility
- Warranted to 300 lbs.

Webpage



GSA SIN # 33721 PENDING

### MODEL / CHAIR TYPE

### ARMS MATERIAL

### DIMENSIONS

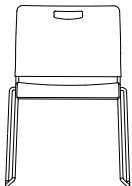

#### 1060 / SLD

Plastic Back - PB &  
Plastic Seat - PS  
Stacking

- Stacks 9 high on the floor
- Stacks 20 high on the optional stacking dolly
- Optional glides available

	P										
A00	\$246										
A61	\$301										

	ARMLESS	ARMS
WIDTH:	23.0	24.0
DEPTH:	21.0	21.0
HEIGHT:	31.0	31.0
SEAT WIDTH:	18.0	18.0
SEAT DEPTH:	16.5	16.5
SEAT HEIGHT:	18.0	18.0
BACK WIDTH:	18.0	18.0
BACK HEIGHT:	14.5	14.5
COM:	N/A	N/A
COL:	N/A	N/A
WEIGHT:	15.0 LB	17.0 LB

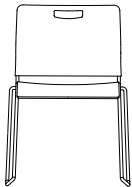

#### 1060 / SLD

Plastic Back - PB &  
Upholstered Seat - US  
Stacking

- Stacks 7 high on the floor
- Stacks 20 high on the optional stacking dolly
- Optional glides available

	A	B/COM	C	D	E	F	G				
A00	\$306	\$336	\$356	\$396	\$436	\$476	\$516				
A61	\$361	\$391	\$411	\$451	\$491	\$531	\$571				

	ARMLESS	ARMS
WIDTH:	23.0	24.0
DEPTH:	21.0	21.0
HEIGHT:	31.0	31.0
SEAT WIDTH:	18.0	18.0
SEAT DEPTH:	16.5	16.5
SEAT HEIGHT:	19.0	19.0
BACK WIDTH:	18.0	18.0
BACK HEIGHT:	14.5	14.5
COM:	0.8 YD	0.8 YD
COL:	N/A	N/A
WEIGHT:	15.0 LB	17.0 LB



### ARM OPTIONS

CODE	DESCRIPTION	PRICE
<b>A61</b>	Aluminum Fixed Arm	+\$55

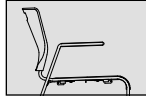

### FRAME COLORS

CODE	DESCRIPTION	PRICE
<b>SLDC</b>	chrome	+\$0

### PLASTIC COLORS

CODE	DESCRIPTION	PRICE
<b>P01</b>	Black Swan	+\$0
<b>P05</b>	White Whisper	+\$0
<b>P11</b>	Federal Blue	+\$0
<b>P12</b>	Crimson Red	+\$0
<b>P13</b>	Lemon Yellow	+\$0
<b>P14</b>	Dove Gray	+\$0
<b>P15</b>	Cloud Gray	+\$0
<b>P16</b>	Lagoon Blue	+\$0
<b>P17</b>	Apple Green	+\$0
<b>P18</b>	Tangerine Orange	+\$0
<b>P19</b>	Latte	+\$0
<b>P20</b>	Azure Blue	+\$0

### STOOL OPTIONS

CODE	DESCRIPTION	PRICE
<b>ST24</b>	24" Counter Stool • Use for work surfaces up to 36" high	+\$130
<b>ST30</b>	30" Bar Stool • Use for work surfaces up to 42" high	+\$150



### ADDITIONAL OPTIONS

CODE	DESCRIPTION	PRICE
<b>G16</b>	Sled Base Clear Plastic Glide • 4 per set	+\$15
<b>G17</b>	Sled Base Clear Plastic Glide with Felt • 4 per set	+\$25

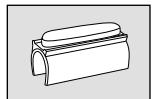
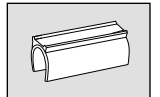

### ACCESSORIES

CODE	DESCRIPTION	PRICE
<b>GC5</b>	Ganging Clip • 4 per set, for 4-leg models • Armless-to-Armless. • 2" Between Chairs When Ganged	+\$20
<b>DL7</b>	Stacking Dolly • Stacks up to 20 High - All Plastic • Stacks up to 16 High - Upholstered Seat	+\$399

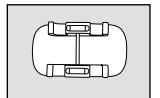



# Kip

MODERN STACKING

## STACKING

- High-density stacking side, guest and stool seating
- Lightweight construction for ultimate portability
- Mesh back and mesh seat
- Warranted to 300 lbs.

Webpage



GSA SIN # 33721 PENDING

### MODEL / CHAIR TYPE

### ARMS MATERIAL

### DIMENSIONS

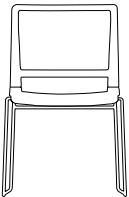

#### 1080 / SLD

Mesh Back - MB &  
Mesh Seat - MS  
Stacking

- Stacks 9 high on the floor
- Stacks 14 high on the optional stacking dolly
- Armrests coordinate with the plastic shell
- Optional glides available

	M											
A00	\$423											
A61	\$478											

	ARMLESS	ARMS
WIDTH:	21.0	24.0
DEPTH:	21.5	21.5
HEIGHT:	33.0	33.0
SEAT WIDTH:	18.5	18.5
SEAT DEPTH:	16.5	16.5
SEAT HEIGHT:	18.5	18.5
BACK WIDTH:	18.0	18.0
BACK HEIGHT:	15.5	15.5
COM:	N/A	N/A
COL:	N/A	N/A
WEIGHT:	14.0 LB	16.0 LB

# Kip

## STACKING

Webpage



GSA SIN # 33721

### ARM OPTIONS

CODE	DESCRIPTION	PRICE
<b>A61</b>	Aluminum Fixed Arm	+\$55

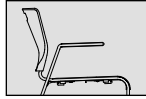

### FRAME COLORS

CODE	DESCRIPTION	PRICE
<b>SLDC</b>	Chrome	+\$0

### PLASTIC COLORS

CODE	DESCRIPTION	PRICE
<b>P01</b>	Black Swan	+\$0
<b>P14</b>	Dove Gray	+\$0

### STOOL OPTIONS

CODE	DESCRIPTION	PRICE
<b>ST24</b>	24" Counter Stool <ul style="list-style-type: none"> <li>Use for work surfaces up to 36" high</li> <li>Optional glides available</li> </ul>	+\$130
<b>ST30</b>	30" Bar Stool <ul style="list-style-type: none"> <li>Use for work surfaces up to 42" high</li> <li>Optional glides available</li> </ul>	+\$150

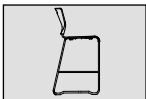

### ADDITIONAL OPTIONS

CODE	DESCRIPTION	PRICE
<b>G16</b>	Sled Base Clear Plastic Glide <ul style="list-style-type: none"> <li>4 per set</li> </ul>	+\$15
<b>G17</b>	Sled Base Clear Plastic Glide with Felt <ul style="list-style-type: none"> <li>4 per set</li> </ul>	+\$25

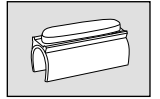
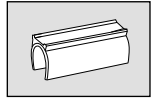

### ACCESSORIES

CODE	DESCRIPTION	PRICE
<b>GC5</b>	Ganging Clip <ul style="list-style-type: none"> <li>4 per set, for 4-leg models</li> <li>Armless-to-Armless.</li> <li>2" Between Chairs When Ganged</li> </ul>	+\$20
<b>DL7</b>	Stacking Dolly <ul style="list-style-type: none"> <li>Stacks up to 14 High</li> </ul>	+\$399

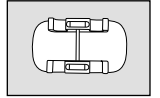





### LAMINATE OPTIONS

CODE	DESCRIPTION	PRICE
<b>BG</b>	Beigewood	+\$0
<b>DW</b>	Designer White	+\$0
<b>OAK</b>	Jubilee Oak	+\$0
<b>WAL</b>	Florence Walnut	+\$0

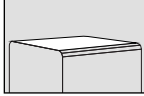

### BASE OPTIONS

CODE	DESCRIPTION	PRICE
<b>BP</b>	Black	+\$0
<b>MGP</b>	Medium Gray	+\$0

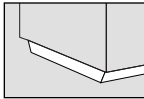

### ADDITIONAL OPTIONS

CODE	DESCRIPTION	PRICE
<b>GC11</b>	Ganging Clip • Set of 2	+\$45
<b>G25B</b>	Adjustable Glides	+\$0
<b>TT</b>	Two-Tone upholstery • *If the two upholstery selections are of different grades, the chair will price at the higher of the two grades. Back and arms are one upholstery.	+\$100

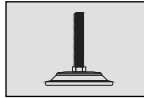

### POWER OPTIONS

CODE	DESCRIPTION	PRICE
<b>P</b>	AC/110V	+\$125
<b>U</b>	USB A+C	+\$230
<b>D</b>	AC/110V & USB	+\$355

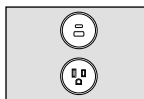
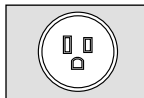

Power and USB gray in color. Power available with bench (9300), single seat (9301), and table (9303).

### POWER LOCATIONS

CODE	DESCRIPTION	CODE	DESCRIPTION
<b>PFL</b>	Power Front Left	<b>USR</b>	USB Side Right
<b>PFR</b>	Power Front Right	<b>UBL</b>	USB Back Left
<b>PSL</b>	Power Side Left	<b>UBR</b>	USB Back Right
<b>PSR</b>	Power Side Right	<b>DFL</b>	Dual Front Left
<b>PBL</b>	Power Back Left	<b>DFR</b>	Dual Front Right
<b>PBR</b>	Power Back Right	<b>DSL</b>	Dual Side Left
<b>UFL</b>	USB Front Left	<b>DSR</b>	Dual Side Right
<b>UFR</b>	USB Front Right	<b>DBL</b>	Dual Back Left
<b>USL</b>	USB Side Left	<b>DBR</b>	Dual Back Right

9300 & 9303  
FRONT AND BACK LOCATIONS

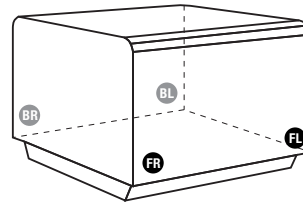

9300 & 9303  
SIDE LOCATIONS

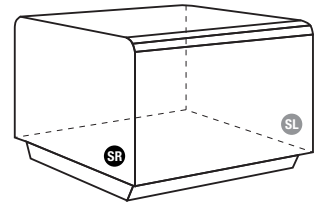

9301  
FRONT AND SIDE LOCATIONS

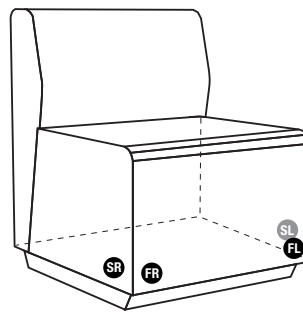



# Koble

CONNECTING TASK AND LOUNGE

## MODULAR

- Choose from a wide variety of seats, benches, tables and ottomans
- Build using straight, 90° or 120° models
- Promote an active working posture with integrated lumbar support and comfort-calibrated seat
- Blend with any environment using black and medium base colors
- Two tone upholstery available
- Power options available
- Adjustable glides standard
- 400 lb. weight rating (per seat)

Webpage



GSA SIN # 33721

### MODEL

### MATERIAL

### DIMENSIONS

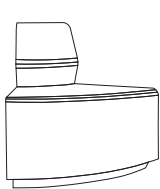

#### 9311 120° Outer Seat

- Shadow base in black or medium gray
- Integrated lumbar support
- Adjustable glides standard
- Two-tone upholstery available

A	B/COM	C	D	E	F	G			
\$0000	\$0000	\$0000	\$0000	\$0000	\$0000	\$0000			
PRICING AVAILABLE SOON									

OVERALL WIDTH: 31.0  
OVERALL DEPTH: 32.0  
OVERALL HEIGHT: 32.5  
SEAT WIDTH: 33.5  
SEAT DEPTH: 18.5  
SEAT HEIGHT: 18.0  
BACK WIDTH: 13.5  
BACK HEIGHT: 14.0  
COM: N/A  
WEIGHT: TBD

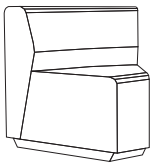

#### 9312 120° Inner Seat

- Shadow base in black or medium gray
- Integrated lumbar support
- Adjustable glides standard
- Two-tone upholstery available

A	B/COM	C	D	E	F	G			
\$0000	\$0000	\$0000	\$0000	\$0000	\$0000	\$0000			
PRICING AVAILABLE SOON									

OVERALL WIDTH: 31.0  
OVERALL DEPTH: 32.5  
OVERALL HEIGHT: 32.5  
SEAT WIDTH: 9.5  
SEAT DEPTH: 18.5  
SEAT HEIGHT: 18.0  
BACK WIDTH: 29.5  
BACK HEIGHT: 14.0  
COM: N/A  
WEIGHT: TBD

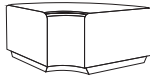

#### 9320 90° Corner Bench

- Shadow base in black or medium gray
- Adjustable glides standard

A	B/COM	C	D	E	F	G			
\$0000	\$0000	\$0000	\$0000	\$0000	\$0000	\$0000			
PRICING AVAILABLE SOON									

OVERALL WIDTH: 35.5  
OVERALL DEPTH: 35.5  
OVERALL HEIGHT: 18.0  
SEAT WIDTH: 47.5  
SEAT DEPTH: 28.0  
SEAT HEIGHT: 18.0  
BACK WIDTH: 0.0  
BACK HEIGHT: 0.0  
COM: N/A  
WEIGHT: 58.5 LB

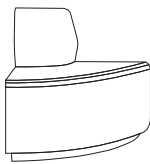

#### 9321 90° Outer Seat

- Shadow base in black or medium gray
- Integrated lumbar support
- Adjustable glides standard
- Two-tone upholstery available

A	B/COM	C	D	E	F	G			
\$0000	\$0000	\$0000	\$0000	\$0000	\$0000	\$0000			
PRICING AVAILABLE SOON									

OVERALL WIDTH: 35.5  
OVERALL DEPTH: 35.5  
OVERALL HEIGHT: 32.5  
SEAT WIDTH: 47.5  
SEAT DEPTH: 18.5  
SEAT HEIGHT: 18.0  
BACK WIDTH: 19.5  
BACK HEIGHT: 14.0  
COM: N/A  
WEIGHT: 64.0 LB

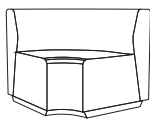

#### 9322 90° Inner Seat

- Shadow base in black or medium gray
- Integrated lumbar support
- Adjustable glides standard
- Two-tone upholstery available

A	B/COM	C	D	E	F	G			
\$3,095	\$3,235	\$3,288	\$3,351	\$3,456	\$3,565	\$3,670			

OVERALL WIDTH: 35.5  
OVERALL DEPTH: 35.5  
OVERALL HEIGHT: 32.5  
SEAT WIDTH: 27.0  
SEAT DEPTH: 18.5  
SEAT HEIGHT: 18.0  
BACK WIDTH: 46.0  
BACK HEIGHT: 14.0  
COM: 5.0 YD  
WEIGHT: 73.5 LB

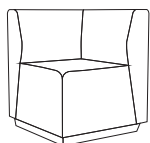

#### 9323 90° Corner Seat

- Shadow base in black or medium gray
- Adjustable glides standard
- Two-tone upholstery available
- Integrated lumbar support

A	B/COM	C	D	E	F	G			
\$2,495	\$2,630	\$2,690	\$2,745	\$2,850	\$2,959	\$3,066			

OVERALL WIDTH: 28.0  
OVERALL DEPTH: 28.0  
OVERALL HEIGHT: 32.5  
SEAT WIDTH: 29.5  
SEAT DEPTH: 28.0  
SEAT HEIGHT: 18.0  
BACK WIDTH: 35.5  
BACK HEIGHT: 14.0  
COM: 4.0 YD  
WEIGHT: 74.0 LB



### LAMINATE OPTIONS

CODE	DESCRIPTION	PRICE
<b>BG</b>	Beigewood	+\$0
<b>DW</b>	Designer White	+\$0
<b>OAK</b>	Jubilee Oak	+\$0
<b>WAL</b>	Florence Walnut	+\$0

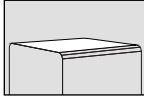

### BASE OPTIONS

CODE	DESCRIPTION	PRICE
<b>BP</b>	Black	+\$0
<b>MGP</b>	Medium Gray	+\$0

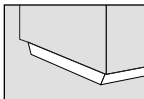

### ADDITIONAL OPTIONS

CODE	DESCRIPTION	PRICE
<b>GC11</b>	Ganging Clip • Set of 2	+\$45
<b>G25B</b>	Adjustable Glides	+\$0
<b>TT</b>	Two-Tone upholstery • *If the two upholstery selections are of different grades, the chair will price at the higher of the two grades. Back and arms are one upholstery.	+\$100



### POWER OPTIONS

CODE	DESCRIPTION	PRICE
<b>P</b>	AC/110V	+\$125
<b>U</b>	USB A+C	+\$230
<b>D</b>	AC/110V & USB	+\$355

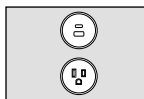
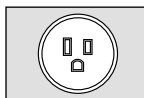

Power and USB gray in color. Power available with bench (9300), single seat (9301), and table (9303).

### POWER LOCATIONS

CODE	DESCRIPTION	CODE	DESCRIPTION
<b>PFL</b>	Power Front Left	<b>USR</b>	USB Side Right
<b>PFR</b>	Power Front Right	<b>UBL</b>	USB Back Left
<b>PSL</b>	Power Side Left	<b>UBR</b>	USB Back Right
<b>PSR</b>	Power Side Right	<b>DFL</b>	Dual Front Left
<b>PBL</b>	Power Back Left	<b>DFR</b>	Dual Front Right
<b>PBR</b>	Power Back Right	<b>DSL</b>	Dual Side Left
<b>UFL</b>	USB Front Left	<b>DSR</b>	Dual Side Right
<b>UFR</b>	USB Front Right	<b>DBL</b>	Dual Back Left
<b>USL</b>	USB Side Left	<b>DBR</b>	Dual Back Right

9300 & 9303  
FRONT AND BACK LOCATIONS

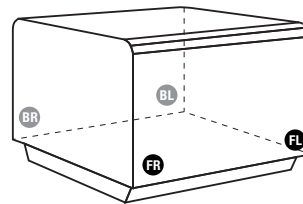

9300 & 9303  
SIDE LOCATIONS

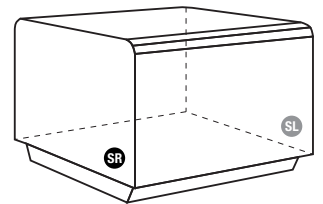

9301  
FRONT AND SIDE LOCATIONS

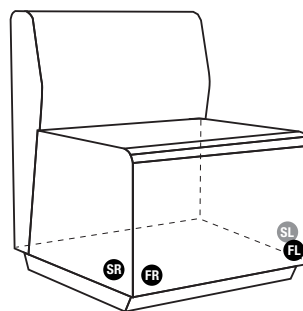



# Koble

CONNECTING TASK AND LOUNGE

## MODULAR

- Choose from a wide variety of seats, benches, tables and ottomans
- Build using straight, 90° or 120° models
- Promote an active working posture with integrated lumbar support and comfort-calibrated seat
- Blend with any environment using black and medium base colors
- Two tone upholstery available
- Power options available
- Adjustable glides standard
- 400 lb. weight rating (per seat)



Webpage

GSA SIN # 33721

### TYPICALS

### MATERIAL

### TOTAL

Typical 1

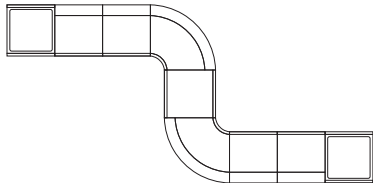

LINE	MODEL	QTY	DESCRIPTION	LIST PRICE / GRADE A	EXT PRICE
1	9300	1	Single Bench	1299	\$1,299
2	9301	4	Single Seat	1625	\$6,500
3	9303	2	Table	1610	\$3,220
4	9322	2	90° Inner Seat	3095	\$6,190
5	G25B	8	Ganging Clip	45	\$360

\$17,569

Typical 2

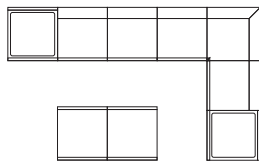

LINE	MODEL	QTY	DESCRIPTION	LIST PRICE / GRADE A	EXT PRICE
1	9303	2	Tables	1610	\$3,220
2	9301	4	Single Seat	1625	\$6,500
3	9300	2	Single Bench	1299	\$2,598
4	9323	1	90° Corner Seat	2495	\$2,495
5	G25B	7	Ganging Clip	45	\$315

\$15,128

Typical 3

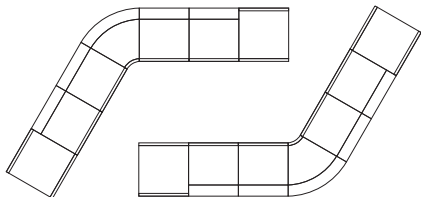

LINE	MODEL	QTY	DESCRIPTION	LIST PRICE / GRADE A	EXT PRICE
1	9300	4	Single Bench	1299	\$5,196
2	9301	8	Single Seat	1625	\$13,000
3	9312	2	120° Inner Seat	TBD	TBD
4	G25B	12	Ganging Clip	45	\$540

TBD

Typical 4

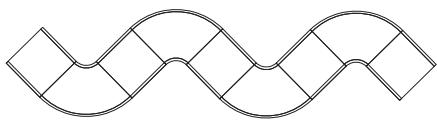

LINE	MODEL	QTY	DESCRIPTION	LIST PRICE / GRADE A	EXT PRICE
1	9320	4	90° corner bench	TBD	TBD
2	9300	5	Single Bench	1299	\$6,495
3	G25B	8	Ganging Clip	45	\$360

TBD

Typical 5

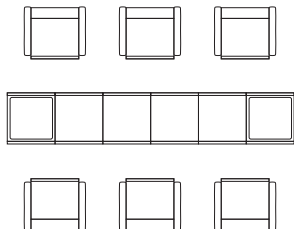

LINE	MODEL	QTY	DESCRIPTION	LIST PRICE / GRADE A	EXT PRICE
1	9301	6	Single Seats W/ Arms	2035	\$12,210
2	9300	4	Single bench	1299	\$5,196
3	9303	2	Table	1610	\$3,220
4	G25B	5	Ganging Clip	45	\$225

\$20,851

Typical 6

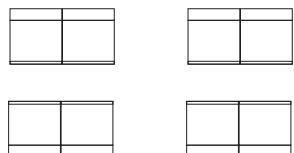

LINE	MODEL	QTY	DESCRIPTION	LIST PRICE / GRADE A	EXT PRICE
1	9301	8	Single Seat	1625	\$13,000
2	G25B	4	Ganging Clip	45	\$180

\$13,180



**TYPICALS**

**MATERIAL**

**TOTAL**

Typical 7

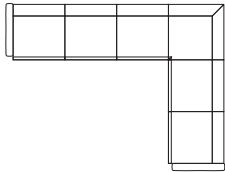

LINE	MODEL	QTY	DESCRIPTION	LIST PRICE / GRADE A	EXT PRICE
1	9301	1	Single Seat W/ Left Arm	1830	\$1,830
2	9301	1	Single Seat W/ Right Arm	1830	\$1,830
3	9301	3	Single Seats	1625	\$4,875
4	9323	1	90° Corner seat	2495	\$2,495
5	G25B	5	Ganging Clip	45	\$225

\$11,255

Typical 8

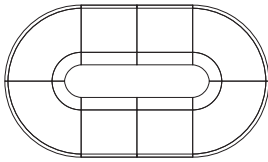

LINE	MODEL	QTY	DESCRIPTION	LIST PRICE / GRADE A	EXT PRICE
1	9320	4	90° Outside Sweep	TBD	TBD
2	9301	4	Single Seat	1625	\$6,500
3	G25B	7	Ganging Clip	45	\$315

TBD



# Lilly

CLASSIC, SOPHISTICATED AND SUPREMELY COMFORTABLE

## MID-BACK LOUNGE

- Lounge, side, stool seating and ottoman
- Classic, sophisticated design
- Warranted to 300 lbs.

Webpage



GSA SIN # 33721

### MODEL / CHAIR TYPE

### MATERIAL

### DIMENSIONS

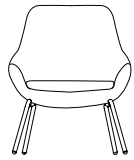

**9101**  
Lounge Chair  
4 Metal Legs

- Black or silver 4-leg base
- Dome glides standard
- Two-tone upholstery available
- Adjustable nylon glides optional

A	B/COM	C	D	E	F	G	L3/COL	L4	L5
\$1,816	\$1,896	\$1,966	\$2,041	\$2,186	\$2,336	\$2,456	\$2,116	\$2,261	\$2,766

WIDTH: 27.0  
DEPTH: 29.0  
HEIGHT: 33.0  
SEAT WIDTH: 23.5  
SEAT DEPTH: 19.0  
SEAT HEIGHT: 16.0  
BACK WIDTH: 23.5  
BACK HEIGHT: 22.0  
COM: 2.9 YD  
COL: 54.0 SQ FT  
WEIGHT: 32.0 LB



**9101**  
Lounge Chair  
Wire Rod Base

- Black or silver wire rod base
- Two-tone upholstery available
- Optional glides available—G16 & G17

A	B/COM	C	D	E	F	G	L3/COL	L4	L5
\$1,897	\$1,977	\$2,047	\$2,122	\$2,267	\$2,417	\$2,537	\$2,197	\$2,342	\$2,847

WIDTH: 27.0  
DEPTH: 29.0  
HEIGHT: 33.0  
SEAT WIDTH: 23.5  
SEAT DEPTH: 19.0  
SEAT HEIGHT: 16.0  
BACK WIDTH: 23.5  
BACK HEIGHT: 22.0  
COM: 2.9 YD  
COL: 54.0 SQ FT  
WEIGHT: 29.0 LB

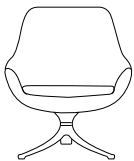

**9101**  
Lounge Chair  
Swivel Base

- Polished and black aluminum swivel base
- Two-tone upholstery available
- Nylon glides standard
- Optional auto-return cylinder

A	B/COM	C	D	E	F	G	L3/COL	L4	L5
\$1,995	\$2,075	\$2,145	\$2,220	\$2,365	\$2,515	\$2,635	\$2,295	\$2,440	\$2,945

WIDTH: 27.0  
DEPTH: 29.0  
HEIGHT: 33.0  
SEAT WIDTH: 23.5  
SEAT DEPTH: 19.0  
SEAT HEIGHT: 16.0  
BACK WIDTH: 23.5  
BACK HEIGHT: 22.0  
COM: 2.9 YD  
COL: 54.0 SQ FT  
WEIGHT: 34.0 LB



**9101**  
Lounge Chair  
4 Wood Legs

- Maple or walnut finish legs
- Ships fully assembled only (AB or AC)
- Two-tone upholstery available
- Adjustable nylon glides standard

A	B/COM	C	D	E	F	G	L3/COL	L4	L5
\$2,180	\$2,260	\$2,330	\$2,405	\$2,550	\$2,700	\$2,820	\$2,480	\$2,625	\$3,130

WIDTH: 27.0  
DEPTH: 29.0  
HEIGHT: 33.0  
SEAT WIDTH: 23.5  
SEAT DEPTH: 19.0  
SEAT HEIGHT: 16.0  
BACK WIDTH: 23.5  
BACK HEIGHT: 22.0  
COM: 2.9 YD  
COL: 54.0 SQ FT  
WEIGHT: 27.0 LB



### BASE OPTIONS

CODE	DESCRIPTION	PRICE	
<b>4LGB</b>	4 Leg • Black	+\$0	
<b>4LGS</b>	4 Leg • Silver	+\$0	
<b>BA20P</b>	Aluminum Swivel Base • Polished	+\$0	
<b>BA20B</b>	Aluminum Swivel Base • Black	+\$0	
<b>CY9N</b>	Free Swivel	+\$0	
<b>CY9NA</b>	Auto Return	+\$50	
<b>MPL</b>	Wood Leg • Maple	+\$0	
<b>WAL</b>	Wood Leg • Walnut	+\$0	
<b>WIRB</b>	Wire Rod • Black	+\$0	
<b>WIRS</b>	Wire Rod • Silver	+\$0	

### ADDITIONAL OPTIONS

CODE	DESCRIPTION	PRICE	
<b>G18</b>	Dome Glide	+\$0	
<b>G8</b>	Swivel Steel Glide • 4 per Set	+\$20	
<b>G9</b>	Swivel Nylon Glide • 4 per Set	+\$20	
<b>G10</b>	Swivel Felt Glide • 4 per Set	+\$20	
<b>G16</b>	Sled Base Clear Plastic Glide • 4 per Seat	+\$15	
<b>G17</b>	Sled Base Clear Plastic Glide with Felt • 4 per Seat	+\$25	
<b>TT</b>	Two Tone Contrasting Upholstery (seat and back) *If the two upholstery selections are of different grades, the chair will price at the higher of the two grades.	+\$100*	



# Lilly

CLASSIC, SOPHISTICATED AND SUPREMELY COMFORTABLE

## SIDE

- Lounge, side, stool seating and ottoman
- Classic, sophisticated design
- Warranted to 300 lbs.

Webpage



GSA SIN # 33721

### MODEL / CHAIR TYPE

### MATERIAL

### DIMENSIONS

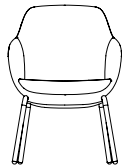

#### 9104

#### Side Chair 4 Metal Legs

- Black or silver 4-leg base
- Two-tone upholstery available
- Dome glides standard
- Adjustable nylon glides optional

A	B/COM	C	D	E	F	G	L3/COL	L4	L5
\$1,546	\$1,626	\$1,686	\$1,756	\$1,896	\$2,026	\$2,146	\$1,796	\$1,971	\$2,341

WIDTH: 24.5  
DEPTH: 24.0  
HEIGHT: 34.5  
SEAT WIDTH: 19.5  
SEAT DEPTH: 18.0  
SEAT HEIGHT: 18.0  
BACK WIDTH: 20.0  
BACK HEIGHT: 20.0  
COM: 2.5 YD  
COL: 45.0 SQ FT  
WEIGHT: 27.0 LB



#### 9104

#### Side Chair Wire Rod Base

- Black or silver wire rod base
- Two-tone upholstery available
- Optional glides available-G16 & G17

A	B/COM	C	D	E	F	G	L3/COL	L4	L5
\$1,596	\$1,676	\$1,736	\$1,806	\$1,946	\$2,076	\$2,196	\$1,846	\$2,021	\$2,391

WIDTH: 24.5  
DEPTH: 24.0  
HEIGHT: 34.5  
SEAT WIDTH: 19.5  
SEAT DEPTH: 18.0  
SEAT HEIGHT: 18.0  
BACK WIDTH: 20.0  
BACK HEIGHT: 20.0  
COM: 2.5 YD  
COL: 45.0 SQ FT  
WEIGHT: 29.5 LB

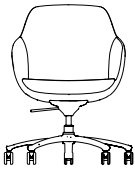

#### 9104

#### Side Chair 5-Star Base

- Polished 5-star base standard
- Mechanism allows front-to-back and side-to-side rocking
- 360° swivel
- Pneumatic cylinder height adjustment
- Two-tone upholstery available

A	B/COM	C	D	E	F	G	L3/COL	L4	L5
\$1,670	\$1,750	\$1,810	\$1,880	\$2,020	\$2,150	\$2,270	\$1,920	\$2,095	\$2,465

WIDTH: 25.0  
DEPTH: 25.0  
HEIGHT: 33.0-37.50  
SEAT WIDTH: 19.5  
SEAT DEPTH: 18.0  
SEAT HEIGHT: 16.5-21.0  
BACK WIDTH: 20.0  
BACK HEIGHT: 19.5  
COM: 2.5 YD  
COL: 45.0 SQ FT  
WEIGHT: 30.0 LB

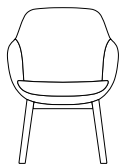

#### 9104

#### Side Chair Wood Base

- Maple or walnut finish
- Silver or black frame color
- Two-tone upholstery available
- Adjustable glides standard

A	B/COM	C	D	E	F	G	L3/COL	L4	L5
\$1,725	\$1,805	\$1,865	\$1,935	\$2,075	\$2,205	\$2,325	\$1,975	\$2,150	\$2,520

WIDTH: 24.5  
DEPTH: 24.0  
HEIGHT: 34.5  
SEAT WIDTH: 19.5  
SEAT DEPTH: 18.0  
SEAT HEIGHT: 18.0  
BACK WIDTH: 20.0  
BACK HEIGHT: 20.0  
COM: 2.5 YD  
COL: 45.0 SQ FT  
WEIGHT: 33.5 LB

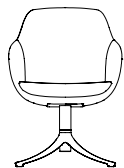

#### 9104

#### Side Chair Swivel Base

- Polished and black aluminum swivel base
- Two-tone upholstery available
- Nylon glides standard
- Optional auto-return cylinder

A	B/COM	C	D	E	F	G	L3/COL	L4	L5
\$1,720	\$1,800	\$1,860	\$1,930	\$2,070	\$2,200	\$2,320	\$1,970	\$2,145	\$2,515

WIDTH: 25.0  
DEPTH: 25.0  
HEIGHT: 33.0-37.50  
SEAT WIDTH: 19.5  
SEAT DEPTH: 18.0  
SEAT HEIGHT: 17.5  
BACK WIDTH: 20.0  
BACK HEIGHT: 20.0  
COM: 2.5 YD  
COL: 45.0 SQ FT  
WEIGHT: 30.0 LB

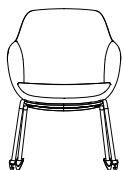

#### 9104

#### Side Chair Wood Rocker

- Maple or walnut finish
- Silver or black frame color
- Two-tone upholstery available
- No glides available

A	B/COM	C	D	E	F	G	L3/COL	L4	L5
\$1,765	\$1,845	\$1,905	\$1,975	\$2,115	\$2,245	\$2,365	\$2,015	\$2,190	\$2,560



WIDTH: 25.0  
DEPTH: 24.0  
HEIGHT: 34.5  
SEAT WIDTH: 19.5  
SEAT DEPTH: 18.0  
SEAT HEIGHT: 17.0  
BACK WIDTH: 20.0  
BACK HEIGHT: 20.0  
COM: 2.5 YD  
COL: 45.0 SQ FT  
WEIGHT: 30.0 LB

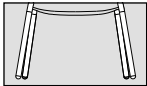
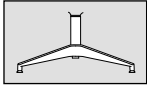
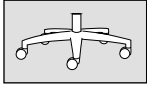
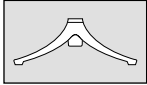
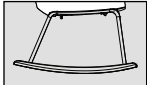
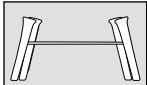
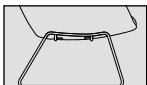

### BASE OPTIONS

CODE	DESCRIPTION	PRICE	
<b>4LGB</b>	4 Leg • Black	+\$0	
<b>4LGS</b>	4 Leg • Silver	+\$0	
<b>BA14P</b>	26" High Profile Aluminum Base • Polished	+\$0	
<b>BA16B</b>	27" Mid-Profile Base • Black	+\$0	
<b>BA16P</b>	27" Mid-Profile Base • Polished	+\$0	
<b>BA20P</b>	Aluminum Swivel Base • Polished	+\$0	
<b>BA20B</b>	Aluminum Swivel Base • Black	+\$0	
<b>CY9N</b>	Free Swivel	+\$0	
<b>CY9NA</b>	Auto Return	+\$50	
<b>RKRMB</b>	Wood Rocker Frame, Maple with Black frame	+\$0	
<b>RKRMS</b>	Wood Rocker Frame, Maple with Silver frame	+\$0	
<b>RKRWB</b>	Wood Rocker Frame, Walnut with Black frame	+\$0	
<b>RKRWS</b>	Wood Rocker Frame, Walnut with Silver Frame	+\$0	
<b>MPL</b>	Wood Leg • Maple	+\$0	
<b>WAL</b>	Wood Leg • Walnut	+\$0	
<b>WIRB</b>	Wire Rod • Black	+\$0	
<b>WIRS</b>	Wire Rod • Silver	+\$0	

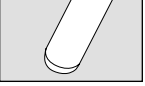
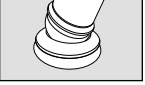
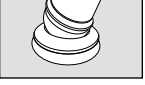
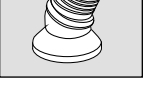
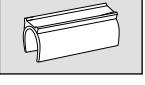
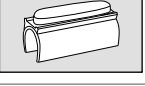
### ADDITIONAL OPTIONS

CODE	DESCRIPTION	PRICE	
<b>G18</b>	Dome Glide	+\$0	
<b>G8</b>	Swivel Steel Glide • 4 per Set	+\$20	
<b>G9</b>	Swivel Nylon Glide • 4 per Set	+\$20	
<b>G10</b>	Swivel Felt Glide • 4 per Set	+\$20	
<b>G16</b>	Sled Base Clear Plastic Glide • 4 per Seat	+\$15	
<b>G17</b>	Sled Base Clear Plastic Glide with Felt • 4 per Seat	+\$25	
<b>TT</b>	Two Tone Contrasting Upholstery (seat and back) *If the two upholstery selections are of different grades, the chair will price at the higher of the two grades.	+\$100*	

### CASTER OPTIONS

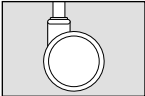
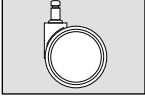
CODE	DESCRIPTION	PRICE	
<b>C6</b>	Large Diameter Carpet Casters	+\$0	
<b>C7</b>	Chrome-Accented Hard Floor and Carpet Casters	+\$0	



# Lilly

CLASSIC, SOPHISTICATED AND SUPREMELY COMFORTABLE

## STOOL

- Lounge, side, stool seating and ottoman
- Classic, sophisticated design
- Warranted to 300 lbs.

Webpage



GSA SIN # 33721

### MODEL / CHAIR TYPE

### MATERIAL

### DIMENSIONS

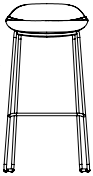

#### 9165 Counter Stool - ST24

- Upholstered seat
- Sled frame with foot rest
- 24" counter stool height
- Use for work surfaces up to 36" high
- Optional glides available - G16 & G17

A	B/COM	C	D	E	F	G	L3/COL	L4	L5
\$965	\$995	\$1,025	\$1,050	\$1,095	\$1,140	\$1,165	\$1,100	\$1,135	\$1,290

WIDTH: 20.0  
 DEPTH: 16.0  
 HEIGHT: 27.0  
 SEAT WIDTH: 16.0  
 SEAT DEPTH: 12.5  
 SEAT HEIGHT: 24.0  
 BACK WIDTH: 15.0  
 BACK HEIGHT: 4.0  
 COM: 0.7 YD  
 COL: 12.0 SQ FT  
 WEIGHT: 14.5 LB

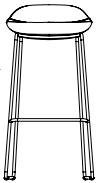

#### 9165 Bar Stool - ST30

- Upholstered seat
- Sled frame with foot rest
- 30" bar stool height
- Use for work surfaces up to 42" high
- Optional glides available - G16 & G17

A	B/COM	C	D	E	F	G	L3/COL	L4	L5
\$985	\$1,015	\$1,045	\$1,070	\$1,115	\$1,160	\$1,185	\$1,120	\$1,155	\$1,310

WIDTH: 20.5  
 DEPTH: 17.0  
 HEIGHT: 33.0  
 SEAT WIDTH: 16.0  
 SEAT DEPTH: 12.5  
 SEAT HEIGHT: 30.5  
 BACK WIDTH: 15.0  
 BACK HEIGHT: 4.0  
 COM: 0.7 YD  
 COL: 12.0 SQ FT  
 WEIGHT: 15.5 LB

# Lilly

## STOOL



Webpage

GSA SIN # 33721

### FRAME COLORS

CODE	DESCRIPTION	PRICE
<b>ST24B</b>	Black	+\$0
<b>ST24S</b>	Silver	+\$0
<b>ST30B</b>	Black	+\$0
<b>ST30S</b>	Silver	+\$0

### ADDITIONAL OPTIONS

CODE	DESCRIPTION	PRICE	
<b>G16</b>	Sled Base Clear Plastic Glide • 4 per Seat	+\$15	
<b>G17</b>	Sled Base Clear Plastic Glide with Felt • 4 per Seat	+\$25	



# Lilly

CLASSIC, SOPHISTICATED AND SUPREMEY COMFORTABLE

## OTTOMAN

- Lounge, side, stool seating and ottoman
- Classic, sophisticated design
- Warranted to 300 lbs.

Webpage



GSA SIN # 33721

### MODEL / CHAIR TYPE

### MATERIAL

### DIMENSIONS



#### 9107

#### Ottoman 4 Metal Legs

- Black or Silver 4-leg base
- Dome glides standard
- Nylon glides standard
- Adjustable nylon glides optional

A	B/COM	C	D	E	F	G	L3/COL	L4	L5
\$675	\$705	\$735	\$795	\$850	\$890	\$950	\$850	\$875	\$1,025

WIDTH: 24.0  
 DEPTH: 23.5  
 HEIGHT: 17.0  
 SEAT WIDTH: 22.0  
 SEAT DEPTH: 21.5  
 SEAT HEIGHT: 17.0  
 BACK WIDTH: N/A  
 BACK HEIGHT: N/A  
 COM: 2.0 YD  
 COL: 15.5 SQ FT  
 WEIGHT: 18.0 LB

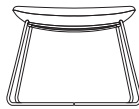

#### 9107

#### Ottoman Wire Rod Sled

- Black or Silver wire rod base
- Optional glides available- G16 & G17

A	B/COM	C	D	E	F	G	L3/COL	L4	L5
\$725	\$755	\$785	\$845	\$900	\$940	\$1,000	\$900	\$925	\$1,075

WIDTH: 24.0  
 DEPTH: 23.5  
 HEIGHT: 17.0  
 SEAT WIDTH: 22.0  
 SEAT DEPTH: 21.5  
 SEAT HEIGHT: 17.0  
 BACK WIDTH: N/A  
 BACK HEIGHT: N/A  
 COM: 2.0 YD  
 COL: 15.5 SQ FT  
 WEIGHT: 20.0 LB



#### 9107

#### Ottoman Wood Leg

- Maple or Walnut finish legs
- Adjustable nylon glides standard

A	B/COM	C	D	E	F	G	L3/COL	L4	L5
\$1,075	\$1,105	\$1,135	\$1,195	\$1,250	\$1,290	\$1,350	\$1,250	\$1,275	\$1,425

WIDTH: 24.0  
 DEPTH: 23.5  
 HEIGHT: 17.0  
 SEAT WIDTH: 22.0  
 SEAT DEPTH: 21.5  
 SEAT HEIGHT: 17.0  
 BACK WIDTH: N/A  
 BACK HEIGHT: N/A  
 COM: 2.0 YD  
 COL: 15.5 SQ FT  
 WEIGHT: 17.5 LB

# Lilly





## OTTOMAN

Webpage



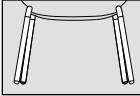
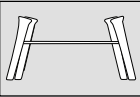
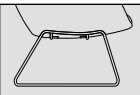



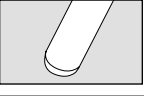

GSA SIN # 33721

### BASE FINISHES

CODE	DESCRIPTION	PRICE	
<b>4LGB</b>	4 Leg • Black	+\$0	
<b>4LGS</b>	4 Leg • Silver	+\$0	
<b>MPL</b>	Wood Leg • Maple	+\$0	
<b>WAL</b>	Wood Leg • Walnut	+\$0	
<b>WIRB</b>	Wire Rod • Black	+\$0	
<b>WIRS</b>	Wire Rod • Silver	+\$0	

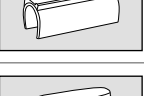
### ADDITIONAL OPTIONS

CODE	DESCRIPTION	PRICE	
<b>G18</b>	Dome Glide	+\$0	
<b>G8</b>	Swivel Steel Glide • 4 per Set	+\$20	
<b>G9</b>	Swivel Nylon Glide • 4 per Set	+\$20	
<b>G10</b>	Swivel Felt Glide • 4 per Set	+\$20	
<b>G16</b>	Sled Base Clear Plastic Glide • 4 per Seat	+\$15	
<b>G17</b>	Sled Base Clear Plastic Glide with Felt • 4 per Seat	+\$25	



# Link

TRANSITIONAL STYLE  
WITH LIMITLESS  
POSSIBILITIES

## GUEST

- Side and guest seating
- Upholstered, mesh or black plastic back options
- 3" molded foam seat
- Wall-saver frame
- Warranted to 300 lbs.

Webpage



GSA SIN # 33721 PENDING

### MODEL / CHAIR TYPE

### ARMS MATERIAL

### DIMENSIONS

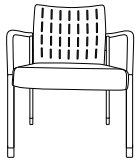

#### 1410 / FRM Plastic Back - PB & Upholstered Seat - US Stacking

- Wall-saver frame
- Perforated black plastic back
- Stacks 4 high on the floor
- Stacks 4 high on the optional stacking dolly
- Not intended for use on vinyl surfaces (LVT, VCT)

	A	B/COM	C	D	E	F	G	L3/COL	L4	L5
A00	\$620	\$650	\$680	\$720	\$770	\$825	\$895	\$795	\$820	\$920
A15	\$690	\$720	\$750	\$790	\$840	\$895	\$965	\$865	\$890	\$990

WIDTH:	25.5
DEPTH:	24.0
HEIGHT:	32.0
SEAT WIDTH:	20.0
SEAT DEPTH:	18.0
SEAT HEIGHT:	17.5
BACK WIDTH:	18.0
BACK HEIGHT:	16.0
COM:	1.3 YD
COL:	12.0 SQ FT
WEIGHT:	21.0 LB



#### 1410 / FRM Mesh Back - MB & Upholstered Seat - US Stacking

- Wall-saver frame
- Breathable mesh back
- Stacks 4 high on the floor
- Stacks 4 high on the optional stacking dolly
- Not intended for use on vinyl surfaces (LVT, VCT)

	A	B/COM	C	D	E	F	G	L3/COL	L4	L5
A00	\$655	\$685	\$715	\$755	\$805	\$860	\$930	\$830	\$855	\$955
A15	\$725	\$755	\$785	\$825	\$875	\$930	\$1,000	\$900	\$925	\$1,025

WIDTH:	25.5
DEPTH:	24.0
HEIGHT:	32.0
SEAT WIDTH:	20.0
SEAT DEPTH:	18.0
SEAT HEIGHT:	17.5
BACK WIDTH:	18.0
BACK HEIGHT:	16.0
COM:	1.3 YD
COL:	12.0 SQ FT
WEIGHT:	21.0 LB

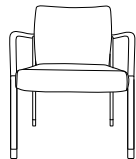

#### 1410 / FRM Upholstered Back - UB & Upholstered Seat - US Stacking

- Wall-saver frame
- Molded foam back
- Stacks 4 high on the floor
- Stacks 4 high on the optional stacking dolly
- Not intended for use on vinyl surfaces (LVT, VCT)

	A	B/COM	C	D	E	F	G	L3/COL	L4	L5
A00	\$655	\$700	\$730	\$778	\$829	\$890	\$950	\$880	\$930	\$1,055
A15	\$725	\$770	\$800	\$848	\$899	\$960	\$1,020	\$950	\$1,000	\$1,125

WIDTH:	25.5
DEPTH:	24.0
HEIGHT:	32.0
SEAT WIDTH:	20.0
SEAT DEPTH:	18.0
SEAT HEIGHT:	17.5
BACK WIDTH:	18.0
BACK HEIGHT:	16.0
COM:	1.3 YD
COL:	29.0 SQ FT
WEIGHT:	23.0 LB



Webpage

GSA SIN # 33721

### ARM OPTIONS

CODE	DESCRIPTION	PRICE
<b>A15B</b>	Soft Touch Arms • Black	+\$70
<b>A15G</b>	Soft Touch Arms • Gray	+\$70

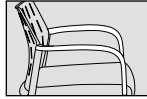

### CASTER OPTIONS

CODE	DESCRIPTION	PRICE
<b>C12S</b>	Hard Floor and Carpet Casters	+\$45

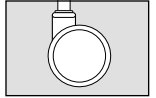

### FRAME COLORS

CODE	DESCRIPTION	PRICE
<b>BF</b>	Black	+\$0
<b>SF</b>	Silver	+\$0

### ACCESSORIES

CODE	DESCRIPTION	PRICE
<b>DL5</b>	Stacking Dolly • Stacks Chairs 4 High	+\$399



### MESH COLORS

CODE	DESCRIPTION	PRICE
<b>M11</b>	Black	+\$0
<b>M12</b>	Gray	+\$0
<b>M13</b>	Silver	+\$0



# Logic

ERGONOMICS, TRADITIONAL TASK  
STYLING - AN UNMATCHED VALUE

## LOW-BACK

- Task, stool, conference and executive seating
- Low-, mid- or high-back models
- Ratchet back lumbar height adjustment on select models
- Heavy duty multi-shift 24/7 optional (350 lb. rating)
- Warranted to 300 lbs.

Webpage



GSA SIN # 33721

### MODEL / CONTROL

### ARMS MATERIAL

### DIMENSIONS

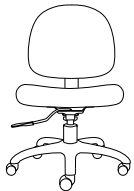

#### 1725 / B2 Low-Back Basic Task with Back Depth Adjustment

- 360° swivel
- Pneumatic cylinder height adjustment
- Adjustable back depth
- Upright lock
- Center knob tension adjustment

	A	B/COM	C	D	E	F	G		
A00	\$623	\$663	\$688	\$733	\$783	\$838	\$908		
A4	\$723	\$763	\$788	\$833	\$883	\$938	\$1008		
A5	\$738	\$778	\$803	\$848	\$898	\$953	\$1023		
A6	\$783	\$823	\$848	\$893	\$943	\$998	\$1068		
A7	\$798	\$838	\$863	\$908	\$958	\$1013	\$1083		
A16	\$748	\$788	\$813	\$858	\$908	\$963	\$1033		
A90	\$863	\$903	\$928	\$973	\$1023	\$1078	\$1148		

WIDTH:	26.5
DEPTH:	26.5
HEIGHT:	38.5-49.5
SEAT WIDTH:	21.0
SEAT DEPTH:	18.5
SEAT HEIGHT:	18.0-23.5
BACK WIDTH:	19.5
BACK HEIGHT:	18.5
COM:	1.4 YD
WEIGHT:	31.0 LB

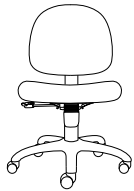

#### 1725 / S2 Low-Back Swivel Tilt

- 360° swivel
- Pneumatic cylinder height adjustment

	A	B/COM	C	D	E	F	G		
A00	\$668	\$708	\$733	\$778	\$828	\$883	\$953		
A4	\$768	\$808	\$833	\$878	\$928	\$983	\$1053		
A5	\$783	\$823	\$848	\$893	\$943	\$998	\$1068		
A6	\$828	\$868	\$893	\$938	\$988	\$1043	\$1113		
A7	\$843	\$883	\$908	\$953	\$1003	\$1058	\$1128		
A16	\$793	\$833	\$858	\$903	\$953	\$1008	\$1078		
A90	\$908	\$948	\$973	\$1018	\$1068	\$1123	\$1193		

WIDTH:	26.5
DEPTH:	26.5
HEIGHT:	35.0-39.5
SEAT WIDTH:	21.0
SEAT DEPTH:	17.0
SEAT HEIGHT:	17.5-22.0
SEAT HEIGHT W/ SEAT SLIDER:	18.5-23.0
BACK WIDTH:	19.5
BACK HEIGHT:	18.5
COM:	1.4 YD
WEIGHT:	34.0 LB

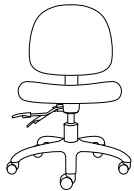

#### 1725 / P1 Low-Back Posture Back

- 360° swivel
- Pneumatic cylinder height adjustment
- Ratchet back lumbar adjustment
- Infinite back angle adjustment with free float

	A	B/COM	C	D	E	F	G		
A00	\$708	\$748	\$773	\$818	\$868	\$923	\$993		
A4	\$808	\$848	\$873	\$918	\$968	\$1023	\$1093		
A5	\$823	\$863	\$888	\$933	\$983	\$1038	\$1108		
A6	\$868	\$908	\$933	\$978	\$1028	\$1083	\$1153		
A7	\$883	\$923	\$948	\$993	\$1043	\$1098	\$1168		
A16	\$833	\$873	\$898	\$943	\$993	\$1048	\$1118		
A90	\$948	\$988	\$1013	\$1058	\$1108	\$1163	\$1233		

WIDTH:	26.5
DEPTH:	26.5
HEIGHT:	35.0-42.5
SEAT WIDTH:	21.0
SEAT DEPTH:	17.0
SEAT HEIGHT:	17.5-22.0
SEAT HEIGHT W/ SEAT SLIDER:	18.5-23.0
BACK WIDTH:	19.5
BACK HEIGHT:	18.5-21.5
COM:	1.4 YD
WEIGHT:	36.0 LB

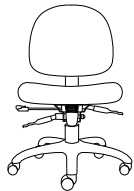

#### 1725 / R1 Low-Back Rocking Tilt

- 360° swivel
- Pneumatic cylinder height adjustment
- Ratchet back lumbar adjustment
- Infinite back angle adjustment
- Infinite tilt lock
- Center knob tension adjustment

	A	B/COM	C	D	E	F	G		
A00	\$718	\$758	\$783	\$828	\$878	\$933	\$1003		
A4	\$818	\$858	\$883	\$928	\$978	\$1033	\$1103		
A5	\$833	\$873	\$898	\$943	\$993	\$1048	\$1118		
A6	\$878	\$918	\$943	\$988	\$1038	\$1093	\$1163		
A7	\$893	\$933	\$958	\$1003	\$1053	\$1108	\$1178		
A16	\$843	\$883	\$908	\$953	\$1003	\$1058	\$1128		
A90	\$958	\$998	\$1023	\$1068	\$1118	\$1173	\$1243		

WIDTH:	26.5
DEPTH:	26.5
HEIGHT:	35.0-42.5
SEAT WIDTH:	21.0
SEAT DEPTH:	17.0
SEAT HEIGHT:	17.5-22.0
SEAT HEIGHT W/ SEAT SLIDER:	18.5-23.0
BACK WIDTH:	19.5
BACK HEIGHT:	18.5-21.5
COM:	1.4 YD
WEIGHT:	38.0 LB

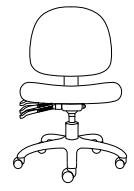

#### 1725 / M1 Low-Back Multi-Function

- Ratchet back lumbar adjustment
- Infinite back angle adjustment
- 6° forward tilt
- Center knob tension adjustment
- 360° swivel
- Pneumatic cylinder height adjustment

	A	B/COM	C	D	E	F	G		
A00	\$768	\$808	\$833	\$878	\$928	\$983	\$1053		
A4	\$868	\$908	\$933	\$978	\$1028	\$1083	\$1153		
A5	\$883	\$923	\$948	\$993	\$1043	\$1098	\$1168		
A6	\$928	\$968	\$993	\$1038	\$1088	\$1143	\$1213		
A7	\$943	\$983	\$1008	\$1053	\$1103	\$1158	\$1228		
A16	\$893	\$933	\$958	\$1003	\$1053	\$1108	\$1178		
A90	\$1008	\$1048	\$1073	\$1118	\$1168	\$1223	\$1293		

WIDTH:	26.5
DEPTH:	26.5
HEIGHT:	35.0-42.5
SEAT WIDTH:	21.0
SEAT DEPTH:	17.0
SEAT HEIGHT:	17.5-22.0
SEAT HEIGHT W/ SEAT SLIDER:	18.5-23
BACK WIDTH:	19.5
BACK HEIGHT:	18.5-21.5
COM:	1.4 YD
WEIGHT:	39.0 LB

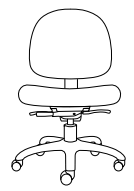

#### 1725 / Y2 Low-Back Heavy Duty Synchro Tilt

- Ratchet back lumbar adjustment
- Seat slider standard
- 4-position tilt lock
- Side knob tension control
- 2:1 back-to-seat tilt ratio
- 360° swivel
- Pneumatic cylinder height adjustment

	A	B/COM	C	D	E	F	G		
A00	\$808	\$848	\$873	\$918	\$968	\$1023	\$1093		
A4	\$908	\$948	\$973	\$1018	\$1068	\$1123	\$1193		
A5	\$923	\$963	\$988	\$1033	\$1083	\$1138	\$1208		
A6	\$968	\$1008	\$1033	\$1078	\$1128	\$1183	\$1253		
A7	\$983	\$1023	\$1048	\$1093	\$1143	\$1198	\$1268		
A16	\$933	\$973	\$998	\$1043	\$1093	\$1148	\$1218		
A90	\$1048	\$1088	\$1113	\$1158	\$1208	\$1263	\$1333		

WIDTH:	26.5
DEPTH:	26.5
HEIGHT:	33.5-41.0
SEAT WIDTH:	21.0
SEAT DEPTH:	17.0-19.5
SEAT HEIGHT:	19.0-23.5
BACK WIDTH:	19.5
BACK HEIGHT:	18.5-21.5
COM:	1.4 YD
WEIGHT:	41.0 LB

# Logic





## LOW-BACK

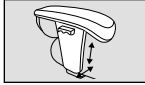

Webpage

GSA SIN # 33721

### ARM OPTIONS

CODE	DESCRIPTION	PRICE	
<b>A4</b>	Height Adjustable Arm	+\$100	
<b>A5</b>	Height/Width Adjustable Arm	+\$115	
<b>A6</b>	Height Adjustable Pivot/Slide Arm with Ultra-Soft Sliding Arm Pads	+\$155	
<b>A7</b>	Height/Width Adjustable Pivot Slide Arm with Ultra-Soft Sliding Arm Pads	+\$175	
<b>A16</b>	Soft Touch C-Shape Arm with Upholstered Pads	+\$125	
<b>A90</b>	Height/Width Adjustable Breakaway Arm	+\$240	



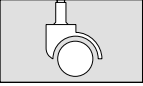
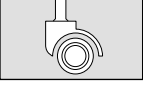
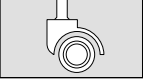

### STOOL OPTIONS

CODE	DESCRIPTION	PRICE	
<b>CY30</b>	8" Stool • Seat Height: 22"-30" • Use for work surfaces up to 36" • Available with B2 or P1	+\$125	
<b>CY36</b>	10" Stool • Seat Height: 25"-36" • Use for work surfaces up to 42" • Available with B2 or P1	+\$125	

### CASTER OPTIONS

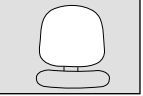
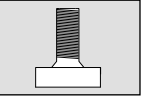
CODE	DESCRIPTION	PRICE	
<b>C1</b>	Carpet Casters	+\$0	
<b>C1S</b>	Hard Floor and Carpet Casters	+\$35	
<b>C2S</b>	Decompression Hard Floor and Soft Carpet Caster	+\$35	

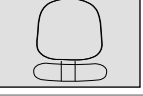
### ADDITIONAL OPTIONS

CODE	DESCRIPTION	PRICE	
<b>BN1</b>	Upholstered Outer Back in Black Ballistic Nylon • with Grade A Only	+\$35	
<b>BN2</b>	Upholstered Outer Back in Black Ballistic Nylon • with Grade B and Up	+\$0	
<b>BT</b>	Replace Knob with Bolt • For B2 or S2 Controls Only	+\$15	
<b>EF1</b>	1" Extra Foam on Seat • If EF1 is selected, cannot use MF1 in addition.	+\$30	
<b>EP</b>	Edge Protector • A Clear Vinyl Tube Placed Around the Edge of the Back Cushion	+\$60	
<b>MF1</b>	1" Visco Elastic Memory Foam on Seat. • If MF1 is selected, cannot use EF1 in addition	+\$50	
<b>SS</b>	Seat Slider 2.5" • Side Paddle Activated • Factory Installed • Available with S2, P1, R1 & M1 • Seat slider not available with stools	+\$60	



# Logic

ERGONOMICS, TRADITIONAL TASK STYLING - AN UNMATCHED VALUE

## MID-BACK

- Task, stool, conference and executive seating
- Low-, mid- or high-back models
- Ratchet back lumbar height adjustment on select models
- Heavy duty multi-shift 24/7 optional (350 lb. rating)
- Warranted to 300 lbs.

Webpage



GSA SIN # 33721

### MODEL / CONTROL

### ARMS MATERIAL

### DIMENSIONS



#### 1760 / S2

##### Mid-Back Swivel Tilt

- Adjustable back depth
- Upright lock
- Center knob tension adjustment
- 360° swivel
- Pneumatic cylinder height adjustment

	A	B/COM	C	D	E	F	G		
A00	\$760	\$815	\$855	\$910	\$1000	\$1085	\$1170		
A4	\$860	\$915	\$955	\$1010	\$1100	\$1185	\$1270		
A5	\$875	\$930	\$970	\$1025	\$1115	\$1200	\$1285		
A6	\$920	\$975	\$1015	\$1070	\$1160	\$1245	\$1330		
A7	\$935	\$990	\$1030	\$1085	\$1175	\$1260	\$1345		
A16	\$885	\$940	\$980	\$1035	\$1125	\$1210	\$1295		
A90	\$1000	\$1055	\$1095	\$1150	\$1240	\$1325	\$1410		

WIDTH:	26.5
DEPTH:	26.0
HEIGHT:	39.0-43.5
SEAT WIDTH:	21.0
SEAT DEPTH:	16.5
SEAT HEIGHT:	17.0-21.5
SEAT HEIGHT W/	
SEAT SLIDER:	18-22.5
BACK WIDTH:	20.0
BACK HEIGHT:	20.5-23.5
COM:	1.6 YD
WEIGHT:	28.5 LB

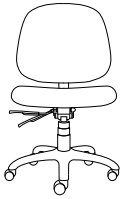

#### 1760 / P1

##### Mid-Back Multi-Function

- Ratchet back lumbar adjustment
- Infinite back angle adjustment
- 6° forward tilt
- Center knob tension adjustment
- 360° swivel
- Pneumatic cylinder height adjustment

	A	B/COM	C	D	E	F	G		
A00	\$800	\$855	\$895	\$950	\$1040	\$1125	\$1210		
A4	\$900	\$955	\$995	\$1050	\$1140	\$1225	\$1310		
A5	\$915	\$970	\$1010	\$1065	\$1155	\$1240	\$1325		
A6	\$960	\$1015	\$1055	\$1110	\$1200	\$1285	\$1370		
A7	\$975	\$1030	\$1070	\$1125	\$1215	\$1300	\$1385		
A16	\$925	\$980	\$1020	\$1075	\$1165	\$1250	\$1335		
A90	\$1040	\$1095	\$1135	\$1190	\$1280	\$1365	\$1450		

WIDTH:	26.5
DEPTH:	26.0
HEIGHT:	39.0-46.5
SEAT WIDTH:	21.0
SEAT DEPTH:	17.5
SEAT HEIGHT:	17.0-21.5
SEAT HEIGHT W/	
SEAT SLIDER:	18.0-22.5
BACK WIDTH:	20.0
BACK HEIGHT:	20.5-23.5
COM:	1.6 YD
WEIGHT:	37.5 LB



#### 1760 / R1

##### Mid-Back Rocking Tilt

- Ratchet back lumbar adjustment
- Infinite back angle adjustment
- Infinite tilt lock
- Center knob tension adjustment
- 360° swivel
- Pneumatic cylinder height adjustment

	A	B/COM	C	D	E	F	G		
A00	\$810	\$865	\$905	\$960	\$1050	\$1135	\$1220		
A4	\$910	\$965	\$1005	\$1060	\$1150	\$1235	\$1320		
A5	\$925	\$980	\$1020	\$1075	\$1165	\$1250	\$1335		
A6	\$970	\$1025	\$1065	\$1120	\$1210	\$1295	\$1380		
A7	\$985	\$1040	\$1080	\$1135	\$1225	\$1310	\$1395		
A16	\$935	\$990	\$1030	\$1085	\$1175	\$1260	\$1345		
A90	\$1050	\$1105	\$1145	\$1200	\$1290	\$1375	\$1460		

WIDTH:	26.5
DEPTH:	26.0
HEIGHT:	39.0-46.5
SEAT WIDTH:	21.0
SEAT DEPTH:	16.5
SEAT HEIGHT:	16.5-21.0
SEAT HEIGHT W/	
SEAT SLIDER:	17.5-22.0
BACK WIDTH:	20.0
BACK HEIGHT:	20.5-23.5
COM:	1.6 YD
WEIGHT:	34.0 LB



#### 1760 / Y2

##### Mid-Back Heavy Duty Synchro Tilt

- Ratchet back lumbar adjustment
- 4-position tilt lock
- Side knob tension adjustment
- 2:1 back-to-seat tilt ratio
- 360° swivel
- Pneumatic cylinder height adjustment

	A	B/COM	C	D	E	F	G		
A00	\$840	\$895	\$935	\$990	\$1080	\$1165	\$1250		
A4	\$940	\$995	\$1035	\$1090	\$1180	\$1265	\$1350		
A5	\$955	\$1010	\$1050	\$1105	\$1195	\$1280	\$1365		
A6	\$1000	\$1055	\$1095	\$1150	\$1240	\$1325	\$1410		
A7	\$1015	\$1070	\$1110	\$1165	\$1255	\$1340	\$1425		
A16	\$965	\$1020	\$1060	\$1115	\$1205	\$1290	\$1375		
A90	\$1080	\$1135	\$1175	\$1230	\$1320	\$1405	\$1490		

WIDTH:	26.5
DEPTH:	26.0
HEIGHT:	37.5-45.0
SEAT WIDTH:	21.0
SEAT DEPTH:	17.5
SEAT HEIGHT:	18.5-23.0
SEAT HEIGHT W/	
SEAT SLIDER:	19.5-24.0
BACK WIDTH:	20.0
BACK HEIGHT:	19.0-22.0
COM:	1.6 YD
WEIGHT:	41.0 LB

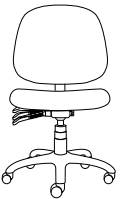

#### 1760 / M1

##### Mid-Back Multi-Function

- Ratchet back lumbar adjustment
- Infinite back angle adjustment
- 6° forward tilt
- Center knob tension adjustment
- 360° swivel
- Pneumatic cylinder height adjustment

	A	B/COM	C	D	E	F	G		
A00	\$860	\$915	\$955	\$1010	\$1100	\$1185	\$1270		
A4	\$960	\$1015	\$1055	\$1110	\$1200	\$1285	\$1370		
A5	\$975	\$1030	\$1070	\$1125	\$1215	\$1300	\$1385		
A6	\$1020	\$1075	\$1115	\$1170	\$1260	\$1345	\$1430		
A7	\$1035	\$1090	\$1130	\$1185	\$1275	\$1360	\$1445		
A16	\$985	\$1040	\$1080	\$1135	\$1225	\$1310	\$1395		
A90	\$1100	\$1155	\$1195	\$1250	\$1340	\$1425	\$1510		

WIDTH:	26.5
DEPTH:	26.0
HEIGHT:	39.0-46.5
SEAT WIDTH:	21.0
SEAT DEPTH:	17.5
SEAT HEIGHT:	17.0-21.5
SEAT HEIGHT W/	
SEAT SLIDER:	18.0-22.5
BACK WIDTH:	20.0
BACK HEIGHT:	20.5-23.5
COM:	1.6 YD
WEIGHT:	37.5 LB

# Logic

## MID-BACK



Webpage

GSA SIN # 33721

### ARM OPTIONS

CODE	DESCRIPTION	PRICE	
<b>A4</b>	Height Adjustable Arm	+\$100	
<b>A5</b>	Height/Width Adjustable Arm	+\$115	
<b>A6</b>	Height Adjustable Pivot/Slide Arm with Ultra-Soft Sliding Arm Pads	+\$160	
<b>A7</b>	Height/Width Adjustable Pivot/Slide Arm with Ultra-Soft Sliding Arm Pads	+\$175	
<b>A16</b>	Soft Touch C-Shape Arm with Upholstered Pad	+\$125	
<b>A90</b>	Height/Width Adjustable Breakaway Arm	+\$240	

### STOOL OPTIONS

CODE	DESCRIPTION	PRICE	
<b>CY30</b>	8" Stool • Seat Height: 22"-30" • Use for work surfaces up to 36" • Available with P1 control only	+\$125	
<b>CY36</b>	10" Stool • Seat Height: 25"-36" • Use for work surfaces up to 42" • Available with P1 control only	+\$125	

### CASTER OPTIONS

CODE	DESCRIPTION	PRICE	
<b>C1</b>	Carpet Casters	+\$0	
<b>C1S</b>	Hard Floor and Carpet Casters	+\$35	
<b>C2S</b>	Decompression Hard Floor and Soft Carpet Caster	+\$35	

### ADDITIONAL OPTIONS

CODE	DESCRIPTION	PRICE	
<b>BN1</b>	Upholstered Outer Back in Black Ballistic Nylon • with Grade A Only	+\$35	
<b>BN2</b>	Upholstered Outer Back in Black Ballistic Nylon • with Grade B and Up	+\$0	
<b>BT</b>	Replace Knob with Bolt • For B2 or S2 Controls Only	+\$15	
<b>EF1</b>	1" Extra Foam on Seat • If EF1 is selected, cannot use MF1 in addition.	+\$30	
<b>EP</b>	Edge Protector • A Clear Vinyl Tube Placed Around the Edge of the Back Cushion	+\$60	
<b>MF1</b>	1" Visco Elastic Memory Foam on Seat. • If MF1 is selected, cannot use EF1 in addition	+\$50	
<b>SS</b>	Seat Slider 2.5" • Side Paddle Activated • Factory Installed • Available with S2, P1, R1 & M1 • Seat slider not available with stools	+\$60	



# Logic

ERGONOMICS, TRADITIONAL TASK STYLING - AN UNMATCHED VALUE

## HIGH-BACK

- Task, stool, conference and executive seating
- Low-, mid- or high-back models
- Ratchet back lumbar height adjustment on select models
- Heavy duty multi-shift 24/7 optional (350 lb. rating)
- Warranted to 300 lbs.

Webpage



GSA SIN # 33721

### MODEL / CONTROL

### ARMS MATERIAL

### DIMENSIONS



#### 1780 / S2

##### High-Back Swivel Tilt

- Adjustable back depth
- Upright lock
- Center knob tension adjustment
- 360° swivel
- Pneumatic cylinder height adjustment

	A	B/COM	C	D	E	F	G		
A00	\$828	\$888	\$938	\$998	\$1088	\$1178	\$1288		
A4	\$928	\$988	\$1038	\$1098	\$1188	\$1278	\$1388		
A5	\$943	\$1003	\$1053	\$1113	\$1203	\$1293	\$1403		
A6	\$988	\$1048	\$1098	\$1158	\$1248	\$1338	\$1448		
A7	\$1003	\$1063	\$1113	\$1173	\$1263	\$1353	\$1463		
A16	\$953	\$1013	\$1063	\$1123	\$1213	\$1303	\$1413		
A90	\$1068	\$1128	\$1178	\$1238	\$1328	\$1418	\$1528		

WIDTH:	26.5
DEPTH:	26.0
HEIGHT:	42.0-49.5
SEAT WIDTH:	21.0
SEAT DEPTH:	16.5
SEAT HEIGHT:	17.0-21.5
SEAT HEIGHT W/ SEAT SLIDER:	18.0-22.5
BACK WIDTH:	20.0
BACK HEIGHT:	24.0-27.0
COM:	1.8 YD
WEIGHT:	36.0 LB



#### 1780 / R1

##### High-Back Rocking Tilt

- Ratchet back lumbar adjustment
- Infinite back angle adjustment
- Infinite tilt lock
- Center knob tension adjustment
- 360° swivel
- Pneumatic cylinder height adjustment

	A	B/COM	C	D	E	F	G		
A00	\$878	\$938	\$988	\$1048	\$1138	\$1228	\$1338		
A4	\$978	\$1038	\$1088	\$1148	\$1238	\$1328	\$1438		
A5	\$993	\$1053	\$1103	\$1163	\$1253	\$1343	\$1453		
A6	\$1038	\$1098	\$1148	\$1208	\$1298	\$1388	\$1498		
A7	\$1053	\$1113	\$1163	\$1223	\$1313	\$1403	\$1513		
A16	\$1003	\$1063	\$1113	\$1173	\$1263	\$1353	\$1463		
A90	\$1118	\$1178	\$1228	\$1288	\$1378	\$1468	\$1578		

WIDTH:	26.5
DEPTH:	26.0
HEIGHT:	42.0-49.5
SEAT WIDTH:	21.0
SEAT DEPTH:	16.5
SEAT HEIGHT:	17.0-21.5
SEAT HEIGHT W/ SEAT SLIDER:	18.0-22.5
BACK WIDTH:	20.0
BACK HEIGHT:	24.0-27.0
COM:	1.8 YD
WEIGHT:	41.0 LB

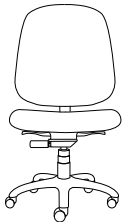

#### 1780 / Y2

##### High-Back Heavy Duty Synchro Tilt

- Ratchet back lumbar adjustment
- 4-position tilt lock
- Side knob tension adjustment
- 2:1 back-to-seat tilt ratio
- 360° swivel
- Pneumatic cylinder height adjustment

	A	B/COM	C	D	E	F	G		
A00	\$908	\$968	\$1018	\$1078	\$1168	\$1258	\$1368		
A4	\$1008	\$1068	\$1118	\$1178	\$1268	\$1358	\$1468		
A5	\$1023	\$1083	\$1133	\$1193	\$1283	\$1373	\$1483		
A6	\$1068	\$1128	\$1178	\$1238	\$1328	\$1418	\$1528		
A7	\$1083	\$1143	\$1193	\$1253	\$1343	\$1433	\$1543		
A16	\$1033	\$1093	\$1143	\$1203	\$1293	\$1383	\$1493		
A90	\$1148	\$1208	\$1258	\$1318	\$1408	\$1498	\$1608		

WIDTH:	26.5
DEPTH:	26.0
HEIGHT:	40.5-48.0
SEAT WIDTH:	21.0
SEAT DEPTH:	17.5
SEAT HEIGHT:	17.0-21.5
SEAT HEIGHT W/ SEAT SLIDER:	18.0-22.5
BACK WIDTH:	20.0
BACK HEIGHT:	24.0-27.0
COM:	1.8 YD
WEIGHT:	43.0 LB

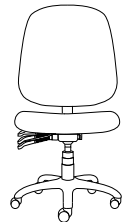

#### 1780 / M1

##### High-Back Multi-Function

- Ratchet back lumbar adjustment
- Infinite back angle adjustment
- 6° forward tilt
- Center knob tension adjustment
- 360° swivel
- Pneumatic cylinder height adjustment

	A	B/COM	C	D	E	F	G		
A00	\$928	\$988	\$1038	\$1098	\$1188	\$1278	\$1388		
A4	\$1028	\$1088	\$1138	\$1198	\$1288	\$1378	\$1488		
A5	\$1043	\$1103	\$1153	\$1213	\$1303	\$1393	\$1503		
A6	\$1088	\$1148	\$1198	\$1258	\$1348	\$1438	\$1548		
A7	\$1103	\$1163	\$1213	\$1273	\$1363	\$1453	\$1563		
A16	\$1053	\$1113	\$1163	\$1223	\$1313	\$1403	\$1513		
A90	\$1168	\$1228	\$1278	\$1338	\$1428	\$1518	\$1628		

WIDTH:	26.5
DEPTH:	26.0
HEIGHT:	42.0-49.5
SEAT WIDTH:	21.0
SEAT DEPTH:	17.5
SEAT HEIGHT:	17.0-21.5
SEAT HEIGHT W/ SEAT SLIDER:	18.0-22.5
BACK WIDTH:	20.0
BACK HEIGHT:	24.0-27.0
COM:	1.8 YD
WEIGHT:	45.0 LB

# Logic





## HIGH-BACK

Webpage



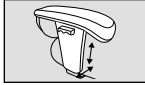

GSA SIN # 33721



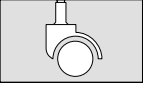
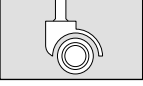

### ARM OPTIONS

CODE	DESCRIPTION	PRICE	
<b>A4</b>	Height Adjustable Arm	+\$100	
<b>A5</b>	Height/Width Adjustable Arm	+\$115	
<b>A6</b>	Height Adjustable Pivot/Slide Arm with Ultra-Soft Sliding Arm Pads	+\$160	
<b>A7</b>	Height/Width Adjustable Pivot Slide Arm with Ultra-Soft Sliding Arm Pads	+\$175	
<b>A16</b>	Soft Touch C-Shape Arm with Upholstered Pad	+\$125	
<b>A90</b>	Height/Width Adjustable Breakaway Arm	+\$240	

### CASTER OPTIONS

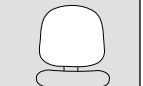
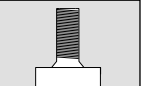
CODE	DESCRIPTION	PRICE	
<b>C1</b>	Carpet Casters	+\$0	
<b>C1S</b>	Hard Floor and Carpet Casters	+\$35	
<b>C2S</b>	Decompression Hard Floor and Soft Carpet Caster	+\$35	

### ADDITIONAL OPTIONS

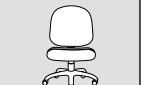
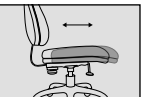
CODE	DESCRIPTION	PRICE	
<b>BN1</b>	Upholstered Outer Back in Black Ballistic Nylon • with Grade A Only	+\$35	
<b>BN2</b>	Upholstered Outer Back in Black Ballistic Nylon • with Grade B and Up	+\$0	
<b>BT</b>	Replace Knob with Bolt • For B2 or S2 Controls Only	+\$15	
<b>EF1</b>	1" Extra Foam on Seat • If EF1 is selected, cannot use MF1 in addition.	+\$30	
<b>EP</b>	Edge Protector • A Clear Vinyl Tube Placed Around the Edge of the Back Cushion	+\$60	
<b>HD</b>	Heavy Duty Multi-Shift Upgrade 350 lb. • Includes BA2 Aluminum Base and C4 60mm Casters • Available with M1 and Y2 Only	+\$125	
<b>MF1</b>	1" Visco Elastic Memory Foam on Seat. • If MF1 is selected, cannot use EF1 in addition	+\$50	
<b>SS</b>	Seat Slider 2.5" • Side Paddle Activated • Factory Installed • Available with S2, P1, R1 & M1	+\$60	



# Logic Plus

ERGONOMICS, TRADITIONAL TASK  
STYLING - AN UNMATCHED VALUE

## HIGH-BACK

- Task seating
- Heavy duty multi-function control, base and pneumatic cylinder
- Ratchet back lumbar height adjustment
- Seat slider standard
- Warranted to 500 lbs.



GSA SIN # 33721

### MODEL / CONTROL

### ARMS MATERIAL

### DIMENSIONS



#### 1790 / M2

#### High-Back Heavy Duty Multi-Function

- Weight capacity up to 500 lbs.
- Infinite back angle adjustment
- 6° forward tilt
- Side knob tension adjustment
- 360° swivel
- Pneumatic cylinder height adjustment

	A	B/COM	C	D	E	F	G		
A00	\$1361	\$1471	\$1541	\$1641	\$1801	\$1941	\$2101		
A5	\$1476	\$1586	\$1656	\$1756	\$1916	\$2056	\$2216		
A36	\$1486	\$1596	\$1666	\$1766	\$1926	\$2066	\$2226		
A37	\$1501	\$1611	\$1681	\$1781	\$1941	\$2081	\$2241		
A90	\$1601	\$1711	\$1781	\$1881	\$2041	\$2181	\$2341		

WIDTH: 30.0-33.0  
DEPTH: 28.0  
HEIGHT: 43.5-52.0  
SEAT WIDTH: 25.0  
SEAT DEPTH: 17.0-20.0  
SEAT HEIGHT: 17.0-22.0  
BACK WIDTH: 23.5  
BACK HEIGHT: 26.5-30.5  
COM: 3.1 YD  
WEIGHT: 65.0 LB

# Logic Plus

## HIGH-BACK

Webpage



GSA SIN # 33721

### ARM OPTIONS

CODE	DESCRIPTION	PRICE	
<b>A5</b>	Height/Width Adjustable Arm	+\$115	
<b>A36</b>	Height Adjustable Pivot/Slide Arm	+\$125	
<b>A37</b>	Height/Width Adjustable Pivot/Slide Arm	+\$140	
<b>A90</b>	Height/Width Adjustable Breakaway Arm	+\$240	



### BASE OPTIONS

CODE	DESCRIPTION	PRICE	
<b>BATHD</b>	26" Heavy Duty Nylon Base • Black	+\$0	

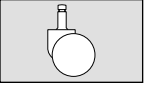
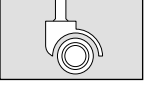
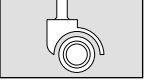
### CASTER OPTIONS

CODE	DESCRIPTION	PRICE	
<b>C4</b>	Heavy Duty Hard Wood Floor and Carpet Casters	+\$0	
<b>C1S</b>	Hard Floor and Carpet Casters	+\$35	
<b>C2S</b>	Decompression Hard Floor and Soft Carpet Caster	+\$35	

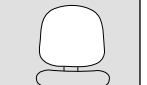
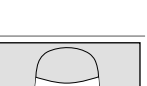
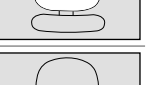
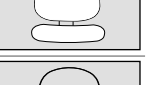
### ADDITIONAL OPTIONS

CODE	DESCRIPTION	PRICE	
<b>BN1</b>	Upholstered Outer Back in Black Ballistic Nylon • with Grade A Only	+\$35	
<b>BN2</b>	Upholstered Outer Back in Black Ballistic Nylon • with Grade B and Up	+\$0	
<b>BNBP1</b>	Ballistic Nylon Applied Over a Portion of the Lower Backrest Surface	+\$90	
<b>BNBP2</b>	Ballistic Nylon Applied Over a Portion of the Lower Backrest Surface and Full Seat	+\$180	
<b>EP</b>	Edge Protector • A Clear Vinyl Tube Placed Around the Edge of the Back Cushion	+\$60	



# Luna

HIGH DESIGN MEETS SUPREME ERGONOMICS

## MESH BACK TASK

- Task, stool, conference, executive, side and guest seating
- Seat slider standard
- Polished aluminum accents
- Height-adjustable lumbar optional
- Warranted to 300 lbs.

Webpage



GSA SIN # 33721

### MODEL / CONTROL

### ARMS MATERIAL

### DIMENSIONS



#### 3460 / Y1 Mesh Back - MB & Upholstered Seat - US Simple Synchro Tilt

- Seat slider standard
- Upright tilt lock
- 3:1 back-to-seat tilt ratio
- Center knob tension adjustment
- 360° swivel
- Pneumatic cylinder height adjustment

	A	B/COM	C	D	E	F	G	L3/COL	L4	L5
A00	\$769	\$799	\$829	\$889	\$944	\$984	\$1,044	\$984	\$1,044	\$1,144
A43	\$844	\$874	\$904	\$964	\$1,019	\$1,059	\$1,119	\$1,059	\$1,119	\$1,219
A45	\$859	\$889	\$919	\$979	\$1,034	\$1,074	\$1,134	\$1,074	\$1,134	\$1,234

ARMS	
WIDTH:	27.0
DEPTH:	27.0
HEIGHT:	39.5-44.0
SEAT WIDTH:	20.0
SEAT DEPTH:	16.0-18.5
SEAT HEIGHT:	16.0-20.5
BACK WIDTH:	21.5
BACK HEIGHT:	23.5
COM:	0.9 YD
COL:	13 SQ FT
WEIGHT:	41.0 LB

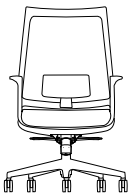

#### 3460 / Y3 Mesh Back - MB & Upholstered Seat - US Full Synchro Tilt

- Seat slider standard
- 3-position tilt lock
- 2:1 back-to-seat tilt ratio
- Center knob tension adjustment
- 360° swivel
- Pneumatic cylinder height adjustment

	A	B/COM	C	D	E	F	G	L3/COL	L4	L5
A00	\$809	\$839	\$869	\$929	\$984	\$1,024	\$1,084	\$1,024	\$1,084	\$1,184
A43	\$884	\$914	\$944	\$1,004	\$1,059	\$1,099	\$1,159	\$1,099	\$1,159	\$1,259
A45	\$899	\$929	\$959	\$1,019	\$1,074	\$1,114	\$1,174	\$1,114	\$1,174	\$1,274

ARMS	
WIDTH:	27.0
DEPTH:	27.0
HEIGHT:	41.0-45.5
SEAT WIDTH:	20.0
SEAT DEPTH:	16.5-19.5
SEAT HEIGHT:	16-20.5
BACK WIDTH:	21.5
BACK HEIGHT:	24.0
COM:	0.9 YD
COL:	13 SQ FT
WEIGHT:	43.0 LB

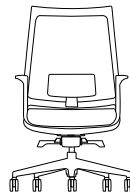

#### 3460 / W1 Mesh Back - MB & Upholstered Seat - US Weight-Balanced Synchro Tilt

- Seat slider standard
- Automatic tension adjustment
- 2-position tilt lock
- 3:1 back-to-seat tilt ratio
- 360° swivel
- Pneumatic cylinder height adjustment

	A	B/COM	C	D	E	F	G	L3/COL	L4	L5
A00	\$824	\$854	\$884	\$944	\$999	\$1,039	\$1,099	\$1,039	\$1,099	\$1,199
A43	\$899	\$929	\$959	\$1,019	\$1,074	\$1,114	\$1,174	\$1,114	\$1,174	\$1,274
A45	\$914	\$944	\$974	\$1,034	\$1,089	\$1,129	\$1,189	\$1,129	\$1,189	\$1,289

ARMS	
WIDTH:	27.0
DEPTH:	27.0
HEIGHT:	40.0-44.5
SEAT WIDTH:	20.0
SEAT DEPTH:	16.5-19.5
SEAT HEIGHT:	16.0-20.5
BACK WIDTH:	21.5
BACK HEIGHT:	24.0
COM:	0.9 YD
COL:	13 SQ FT
WEIGHT:	41.0 LB

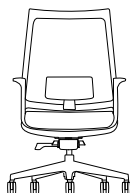

#### 3460 / W2 Mesh Back - MB & Upholstered Seat - US Advanced Weight-Balanced Synchro Tilt

- Seat slider standard
- Automatic tension adjustment with option to modify
- 4-position tilt lock
- 3:1 back-to-seat tilt ratio
- 360° swivel
- Pneumatic cylinder height adjustment

	A	B/COM	C	D	E	F	G	L3/COL	L4	L5
A00	\$854	\$884	\$914	\$974	\$1,029	\$1,069	\$1,129	\$1,069	\$1,129	\$1,229
A43	\$929	\$959	\$989	\$1,049	\$1,104	\$1,144	\$1,204	\$1,144	\$1,204	\$1,304
A45	\$944	\$974	\$1,004	\$1,064	\$1,119	\$1,159	\$1,219	\$1,159	\$1,219	\$1,319

ARMS	
WIDTH:	27.0
DEPTH:	27.0
HEIGHT:	40.0-44.5
SEAT WIDTH:	20.0
SEAT DEPTH:	16.5-19.5
SEAT HEIGHT:	16.0-20.5
BACK WIDTH:	21.5
BACK HEIGHT:	24.0
COM:	0.9 YD
COL:	13 SQ FT
WEIGHT:	41.0 LB



### ARM OPTIONS

CODE	DESCRIPTION	PRICE	
<b>A43B</b>	Fixed Arm • Black	+\$75	
<b>A43D</b>	Fixed Arm • Dove Gray	+\$75	
<b>A45B</b>	4-Way Height and Width Adjustable Arm • Black	+\$75	
<b>A45D</b>	4-Way Height and Width Adjustable Arm • Dove Gray	+\$75	

### PLASTIC COLORS

CODE	DESCRIPTION	PRICE
<b>PBK</b>	Black	+\$0
<b>PDG</b>	Dove Gray	+\$35

### MESH COLORS

CODE	DESCRIPTION	PRICE	CODE	DESCRIPTION	PRICE
<b>M21</b>	Black, M2	+\$0	<b>M41</b>	Cloud, M4	+\$0
<b>M22</b>	Gray, M2	+\$0	<b>M42</b>	Lemon, M4	+\$0
<b>M23</b>	White, M2	+\$0	<b>M43</b>	Apple, M4	+\$0
<b>M24</b>	Green, M2	+\$0	<b>M46</b>	Crimson Red, M4	+\$0
<b>M25</b>	Red, M2	+\$0	<b>M48</b>	Onyx, M4	+\$0
<b>M26</b>	Blue, M2	+\$0	<b>M49</b>	Dove, M4	+\$0
<b>M27</b>	Orange, M2	+\$0	<b>M50</b>	Azure, M4	+\$0
<b>M28</b>	Aqua, M2	+\$0	<b>M51</b>	Federal Blue, M4	+\$0
<b>M40</b>	Latte, M4	+\$0	<b>M52</b>	White Whisper, M4	+\$0

### STOOL OPTIONS

CODE	DESCRIPTION	PRICE	
<b>CY30</b>	8" Stool • (Seat Height: 22"-30") • Use for work surfaces up to 36" • Available with Y1	+\$125	
<b>CY36</b>	10" Stool • (Seat Height: 25"-36") • Use for work surfaces up to 42" • Available with Y1	+\$125	

### BASE OPTIONS

CODE	DESCRIPTION	PRICE	
<b>BA11B</b>	27" Mid-Profile Nylon • Black	+\$0	
<b>BA11D</b>	27" Mid-Profile Nylon • Dove Gray	+\$0	
<b>BA12P</b>	27" Mid-Profile Aluminum Base • Polished	+\$110	

### CASTER OPTIONS

CODE	DESCRIPTION	PRICE	
<b>C6</b>	Large Diameter Carpet Casters	+\$0	
<b>C6S</b>	Large Diameter Hard Floor and Carpet Casters	+\$35	
<b>C7</b>	Chrome-Accented Hard Floor and Carpet Casters	+\$35	
<b>C22B</b>	Hubless Hard Floor and Carpet Casters • Black	+\$0	
<b>C22G</b>	Hubless Hard Floor and Carpet Casters • Gray	+\$0	

### ADDITIONAL OPTIONS

CODE	DESCRIPTION	PRICE	
<b>LB</b>	Height Adjustable Lumbar • When selecting M21 & M22 mesh, a lumbar (LB) will be included at no charge	+\$30	
<b>HD</b>	Heavy Duty Multi-Shift • Upgrade 350 lb. • Includes BA12P High Profile Aluminum Base (Y3 control only)	+\$125	
<b>G1</b>	Stationary Base Glide	+\$30	



# Luna

HIGH DESIGN MEETS SUPREME ERGONOMICS

## MESH BACK GUEST

- Task, stool, conference, executive, side and guest seating
- Wall-saver frame
- Integrated pull handle at top edge
- Warranted to 300 lbs.

Webpage



GSA SIN # 33721

### MODEL / CHAIR TYPE

### ARMS MATERIAL

### DIMENSIONS

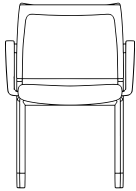

#### 3461 / FRM

#### Mesh Back - MB & Upholstered Seat - US Guest

- Integrated pull handle
- Stacks armless 4 on the floor and 6 on a dolly
- Stacks armed 4 on the floor and 5 on a dolly
- Arms and glides coordinate with the frame color

	A	B/COM	C	D	E	F	G					
A00	\$426	\$451	\$476	\$506	\$541	\$586	\$626					
A49	\$486	\$511	\$536	\$566	\$601	\$646	\$686					

	ARMLESS	ARMS
WIDTH:	19.0	22.5
DEPTH:	23.5	23.5
HEIGHT:	34.0	34.0
SEAT WIDTH:	18.5	18.5
SEAT DEPTH:	17.0	17.0
SEAT HEIGHT:	18.5	18.5
BACK WIDTH:	19.5	19.5
BACK HEIGHT:	16.0	16.0
COM:	0.9 YD	0.9 YD
COL:	11 SQ FT	11 SQ FT
WEIGHT:	15.5 LB	17.5 LB



### ARM OPTIONS

CODE	DESCRIPTION	PRICE
<b>A49B</b>	Nylon Fixed Arm • Black	+\$60
<b>A49D</b>	Nylon Fixed Arm • Dove Gray	+\$60

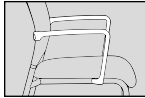

### FRAME COLORS

CODE	DESCRIPTION	PRICE
<b>4LGB</b>	Black	+\$0
<b>4LGS</b>	Silver	+\$0

### PLASTIC COLORS

CODE	DESCRIPTION	PRICE
<b>PBK</b>	Black	+\$0
<b>PDG</b>	Dove Gray	+\$0

### MESH COLORS

CODE	DESCRIPTION	PRICE	CODE	DESCRIPTION	PRICE
<b>M21</b>	Black, M2	+\$0	<b>M41</b>	Cloud, M4	+\$0
<b>M22</b>	Gray, M2	+\$0	<b>M42</b>	Lemon, M4	+\$0
<b>M23</b>	White, M2	+\$0	<b>M43</b>	Apple, M4	+\$0
<b>M24</b>	Green, M2	+\$0	<b>M46</b>	Crimson Red, M4	+\$0
<b>M25</b>	Red, M2	+\$0	<b>M48</b>	Onyx, M4	+\$0
<b>M26</b>	Blue, M2	+\$0	<b>M49</b>	Dove, M4	+\$0
<b>M27</b>	Orange, M2	+\$0	<b>M50</b>	Azure, M4	+\$0
<b>M28</b>	Aqua, M2	+\$0	<b>M51</b>	Federal Blue, M4	+\$0
<b>M40</b>	Latte, M4	+\$0	<b>M52</b>	White Whisper, M4	+\$0

### CASTER OPTIONS

CODE	DESCRIPTION	PRICE
<b>C5</b>	Carpet Casters	+\$45
<b>C5S</b>	Hard Floor and Carpet Casters	+\$75

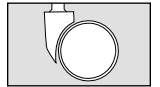
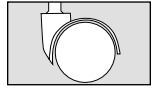

### ADDITIONAL OPTIONS

CODE	DESCRIPTION	PRICE
<b>G19B</b>	Tapered Plastic Glide • Black	+\$0
<b>G19G</b>	Tapered Plastic Glide • Gray	+\$0
<b>G19BN</b>	Swivel Nylon Glide • Black Nylon	+\$20
<b>G19GN</b>	Swivel Nylon Glide • Gray Nylon	+\$20
<b>G19BS</b>	Swivel Steel Glide • Black Steel	+\$20
<b>G19GS</b>	Swivel Steel Glide • Gray Steel	+\$20
<b>G19BF</b>	Swivel Felt Glide • Black Felt	+\$20
<b>G19GF</b>	Swivel Felt Glide • Gray Felt	+\$20

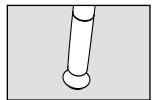
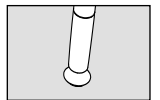
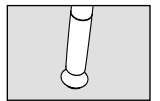
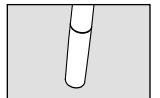

### ACCESSORIES

CODE	DESCRIPTION	PRICE
<b>GC1</b>	Ganging Clip • 2 per Set • Armless-to-Armless	+\$30
<b>GC2</b>	Ganging Clip • 2 per Set • Arm-to-Arm	+\$30
<b>DL5</b>	Stacking Dolly • Stacks 6 armless • Stacks 5 armed	+\$399

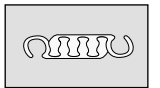



# Mila

ELEGANT, INTUITIVE AND VERSATILE

## MESH BACK, KNIT BACK & UPHOLSTERED BACK

- Conference and executive seating
- Weight-balanced control
- Sculpted aluminum frame
- Mesh, knit or upholstered back
- Warranted to 300 lbs.

Webpage



GSA SIN # 33721

### MODEL / CONTROL

### ARMS MATERIAL

### DIMENSIONS

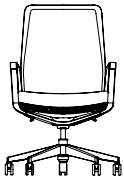

#### 3760 / Z1 Mesh Back - MB Simple Weight Balanced

- Urethane covered back frame
- Automatic tension adjustment
- 12° recline or upright tilt lock
- 360° swivel
- Pneumatic cylinder height adjustment

	A	B/COM	C	D	E	F	G	L3/COL	L4	L5
A47	\$1,495	\$1,530	\$1,555	\$1,610	\$1,645	\$1,685	\$1,735	\$1,730	\$1,845	\$1,945

WIDTH: 27.5  
 DEPTH: 27.0  
 HEIGHT: 40.5-45.0  
 SEAT WIDTH: 20.0  
 SEAT DEPTH: 18.0  
 SEAT HEIGHT: 17.0-21.5  
 BACK WIDTH: 20.5  
 BACK HEIGHT: 23.5  
 COM: 1.0 YD  
 COL: 11.0 SQ.FT  
 WEIGHT: 36.5 LB

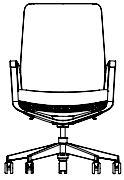

#### 3760 / Z1 Upholstered Back - UB Simple Weight Balanced

- Slim molded foam upholstered back
- Automatic tension adjustment
- 12° recline or upright tilt lock
- 360° swivel
- Pneumatic cylinder height adjustment

	A	B/COM	C	D	E	F	G	L3/COL	L4	L5
A47	\$1,563	\$1,613	\$1,643	\$1,693	\$1,748	\$1,803	\$1,868	\$1,838	\$1,963	\$2,113

WIDTH: 27.5  
 DEPTH: 27.0  
 HEIGHT: 40.5-45.0  
 SEAT WIDTH: 20.0  
 SEAT DEPTH: 18.0  
 SEAT HEIGHT: 17.0-21.5  
 BACK WIDTH: 20.3  
 BACK HEIGHT: 23.5  
 COM: 1.8 YD  
 COL: 33.0 SQ.FT  
 WEIGHT: 36.5 LB

# Mila

## MESH BACK, KNIT BACK & UPHOLSTERED BACK

Webpage



GSA SIN # 33721

### ARM OPTIONS

CODE	DESCRIPTION	PRICE
<b>A47</b>	Fixed Aluminum Arm with Soft Urethane Pad - Black or Gray	+\$0

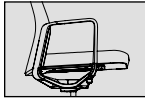

### KNIT BACK COLORS

CODE	DESCRIPTION	PRICE
<b>K01</b>	Black, KB	+\$25
<b>K02</b>	Charcoal Gray, KB	+\$25
<b>K03</b>	Misty Gray, KB	+\$25

### FRAME COLORS

CODE	DESCRIPTION	PRICE
<b>TSKB</b>	Black	+\$0
<b>TSKP</b>	Polished	+\$0

### MESH COLORS

CODE	DESCRIPTION	PRICE	CODE	DESCRIPTION	PRICE
<b>M21</b>	Black, M2	+\$0	<b>M41</b>	Cloud, M4	+\$0
<b>M22</b>	Gray, M2	+\$0	<b>M42</b>	Lemon, M4	+\$0
<b>M23</b>	White, M2	+\$0	<b>M43</b>	Apple, M4	+\$0
<b>M24</b>	Green, M2	+\$0	<b>M46</b>	Crimson, M4	+\$0
<b>M25</b>	Red, M2	+\$0	<b>M48</b>	Onyx, M4	+\$0
<b>M26</b>	Blue, M2	+\$0	<b>M49</b>	Dove, M4	+\$0
<b>M27</b>	Orange, M2	+\$0	<b>M50</b>	Azure, M4	+\$0
<b>M28</b>	Aqua, M2	+\$0	<b>M51</b>	Federal Blue, M4	+\$0
<b>M40</b>	Latte, M4	+\$0	<b>M52</b>	White Whisper, M4	+\$0

### BASE OPTIONS

CODE	DESCRIPTION	PRICE
<b>BA12B</b>	27" Mid-Profile Aluminum Base • Black	+\$0
<b>BA12P</b>	27" Mid-Profile Aluminum Base • Polished • C-7 Chrome-Accented Casters Standard with Polished Base	+\$0
<b>BA12S</b>	27" Mid-Profile Aluminum Base • Silver	+\$0

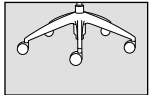

### CASTER OPTIONS

CODE	DESCRIPTION	PRICE
<b>C6</b>	Large Diameter Carpet Casters	+\$0
<b>C6S</b>	Large Diameter Hard Floor and Carpet Casters	+\$35
<b>C7</b>	Chrome-Accented Hard Floor and Carpet Casters	+\$0

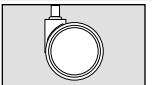
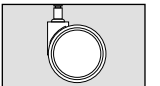
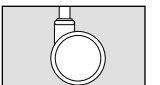



# Neo

THE NEW WAY TO WORK

## MESH BACK TASK

- Task, stool, conference and executive seating
- Integrated height-adjustable lumbar
- Seat slider optional
- Warranted to 300 lbs.

Webpage



GSA SIN # 33721

### MODEL / CONTROL

### ARMS MATERIAL

### DIMENSIONS

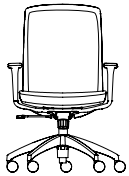

#### 3160 / Y1

##### Simple Synchro Tilt

- Upright tilt lock
- 3:1 back-to-seat tilt ratio
- Center knob tension adjustment
- 360° swivel
- Pneumatic cylinder height adjustment
- Seat slider available as an option

	A	B/COM	C	D	E	F	G	L3/COL	L4	L5
A00	\$603	\$633	\$663	\$723	\$778	\$818	\$878	\$778	\$803	\$953
A23	\$698	\$728	\$758	\$818	\$873	\$913	\$973	\$873	\$898	\$1048
A46	\$678	\$708	\$738	\$798	\$853	\$893	\$953	\$853	\$878	\$1028
A36	\$728	\$758	\$788	\$848	\$903	\$943	\$1003	\$903	\$928	\$1078
A37	\$743	\$773	\$803	\$863	\$918	\$958	\$1018	\$918	\$943	\$1093

WIDTH: 25.5  
 DEPTH: 25.5  
 HEIGHT: 37.0-41.5  
 SEAT WIDTH: 19.5  
 SEAT DEPTH: 17.5-20.0  
 SEAT HEIGHT: 17.0-21.5  
 BACK WIDTH: 17.5  
 BACK HEIGHT: 21.0  
 COM: 1.1 YD  
 COL: 13.0 SQ FT  
 WEIGHT: 35.0 LB

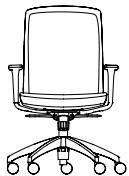

#### 3160 / Y3

##### Full Synchro Tilt

- 3-position tilt lock
- 2:1 back-to-seat tilt ratio
- Center knob tension adjustment
- 360° swivel
- Pneumatic cylinder height adjustment
- Seat slider available as an option

	A	B/COM	C	D	E	F	G	L3/COL	L4	L5
A00	\$643	\$673	\$703	\$763	\$818	\$858	\$918	\$818	\$843	\$993
A23	\$738	\$768	\$798	\$858	\$913	\$953	\$1013	\$913	\$938	\$1088
A46	\$718	\$748	\$778	\$838	\$893	\$933	\$993	\$893	\$918	\$1068
A36	\$768	\$798	\$828	\$888	\$943	\$983	\$1043	\$943	\$968	\$1118
A37	\$783	\$813	\$843	\$903	\$958	\$998	\$1058	\$958	\$983	\$1133

WIDTH: 25.5  
 DEPTH: 25.5  
 HEIGHT: 37.0-41.5  
 SEAT WIDTH: 19.5  
 SEAT DEPTH: 17.5-20.0  
 SEAT HEIGHT: 17.0-21.5  
 BACK WIDTH: 17.5  
 BACK HEIGHT: 21.0  
 COM: 1.1 YD  
 COL: 13.0 SQ FT  
 WEIGHT: 35.0 LB



#### 3160 / W1

##### Weight-Balanced Synchro Tilt

- Automatic tension adjustment
- 2-position tilt lock
- 3:1 back-to-seat tilt ratio
- 360° swivel
- Pneumatic cylinder height adjustment
- Seat slider available as an option

	A	B/COM	C	D	E	F	G	L3/COL	L4	L5
A00	\$658	\$688	\$718	\$778	\$833	\$873	\$933	\$833	\$858	\$1008
A23	\$753	\$783	\$813	\$873	\$928	\$968	\$1028	\$928	\$953	\$1103
A46	\$733	\$763	\$793	\$853	\$908	\$948	\$1008	\$908	\$933	\$1083
A36	\$783	\$813	\$843	\$903	\$958	\$998	\$1058	\$958	\$983	\$1133
A37	\$798	\$828	\$858	\$918	\$973	\$1013	\$1073	\$973	\$998	\$1148

WIDTH: 25.5  
 DEPTH: 25.5  
 HEIGHT: 37.0-41.5  
 SEAT WIDTH: 19.5  
 SEAT DEPTH: 17.5-20.0  
 SEAT HEIGHT: 17.0-21.5  
 BACK WIDTH: 17.5  
 BACK HEIGHT: 21.0  
 COM: 1.1 YD  
 COL: 13.0 SQ FT  
 WEIGHT: 35.0 LB

# Neo

## MESH BACK TASK



GSA SIN # 33721

### ARM OPTIONS

CODE	DESCRIPTION	PRICE
<b>A23B</b>	6-Way Height Adjustable Arm • Black	+\$95
<b>A23G</b>	6-Way Height Adjustable Arm • Graphite Gray	+\$95
<b>A23W</b>	6-Way Height Adjustable Arm • White	+\$95
<b>A36</b>	Height Adjustable Pivot/Slide Arm	+\$125
<b>A37</b>	Height Adjustable Pivot/Slide Arm	+\$140
<b>A46B</b>	Nylon Loop Arm • Black	+\$75
<b>A46G</b>	Nylon Loop Arm • Graphite Gray	+\$75
<b>A46W</b>	Nylon Loop Arm • White	+\$75

### PLASTIC COLORS

CODE	DESCRIPTION	PRICE
<b>PBK</b>	Black	+\$0
<b>PGG</b>	Graphite Gray	+\$35
<b>PWH</b>	White	+\$35

### MESH COLORS

CODE	DESCRIPTION	PRICE	CODE	DESCRIPTION	PRICE
<b>M31</b>	Graphite Mesh, M3	+\$0	<b>M46</b>	Crimson Red, M4	+\$35
<b>M32</b>	Slate Mesh, M3	+\$35	<b>M48</b>	Onyx, M4	+\$35
<b>M33</b>	Snow Mesh, M3	+\$35	<b>M49</b>	Dove, M4	+\$35
<b>M40</b>	Latte, M4	+\$35	<b>M50</b>	Azure, M4	+\$35
<b>M41</b>	Cloud, M4	+\$35	<b>M51</b>	Federal Blue, M4	+\$35
<b>M42</b>	Lemon, M4	+\$35	<b>M52</b>	White Whisper, M4	+\$35
<b>M43</b>	Apple, M4	+\$35			

### STOOL OPTIONS

CODE	DESCRIPTION	PRICE
<b>CY30</b>	8" Stool • (Seat Height: 22"-30") • Use for work surfaces up to 36" • Available with Y1 • Seat slider available as an option	+\$125
<b>CY36</b>	10" Stool • (Seat Height: 25"-36") • Use for work surfaces up to 42" • Available with Y1 • Seat slider available as an option	+\$125

### BASE OPTIONS

CODE	DESCRIPTION	PRICE
<b>BA11B</b>	27" Mid-Profile Nylon • Black	+\$0
<b>BA11G</b>	27" Mid-Profile Nylon • Graphite Gray	+\$0
<b>BA11W</b>	27" Mid-Profile Nylon • White	+\$0
<b>BA12P</b>	27" Mid-Profile Aluminum Base • Polished	+\$110
<b>G1</b>	Stationary Base Glide	+\$30
<b>JB1</b>	Jury Base	+\$300

### CASTER OPTIONS

CODE	DESCRIPTION	PRICE
<b>C6</b>	Large Diameter Carpet Casters	+\$0
<b>C6S</b>	Large Diameter Hard Floor and Carpet Casters	+\$35
<b>C7</b>	Chrome-Accented Hard Floor and Carpet Casters	+\$35

### ADDITIONAL OPTIONS

CODE	DESCRIPTION	PRICE
<b>SS</b>	Seat Slider 2.5" • Side Paddle Activated • Seat slider available with Y1, Y3 & W1	+\$60



# Neo Lite

EQUAL PARTS OF DESIGN,  
COMFORT AND VALUE

## MESH BACK TASK

- Task, stool, conference and executive seating
- Integrated height-adjustable lumbar standard
- Warranted to 300 lbs.

Webpage



GSA SIN # 33721

### MODEL / CONTROL

### ARMS MATERIAL

### DIMENSIONS

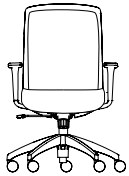

#### 3150 / Y1 Simple Synchro Tilt

- Upright tilt lock
- 3:1 back-to-seat tilt ratio
- Center knob tension adjustment
- 360° swivel
- Pneumatic cylinder height adjustment

	A	B/COM	C	D	E	F	G	L3/COL	L4	L5
A00	\$546	\$576	\$606	\$666	\$721	\$761	\$821	\$721	\$746	\$896
A23	\$641	\$671	\$701	\$761	\$816	\$856	\$916	\$816	\$841	\$991
A36	\$671	\$701	\$731	\$791	\$846	\$886	\$946	\$846	\$871	\$1021
A37	\$686	\$716	\$746	\$806	\$861	\$901	\$961	\$861	\$886	\$1036
A46	\$621	\$651	\$681	\$741	\$796	\$836	\$896	\$796	\$821	\$971

WIDTH: 25.0  
DEPTH: 26.0  
HEIGHT: 38.0-42.5  
SEAT WIDTH: 19.5  
SEAT DEPTH: 18.5  
SEAT HEIGHT: 18.0-22.5  
BACK WIDTH: 17.5  
BACK HEIGHT: 21.5  
COM: .9 YD  
COL: 11.0 LB  
WEIGHT: 34.0 LB

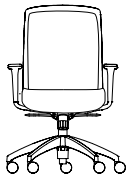

#### 3150 / Y3 Full Synchro Tilt

- 3-position tilt lock
- 2:1 back-to-seat tilt ratio
- Center knob tension adjustment
- 360° swivel
- Pneumatic cylinder height adjustment

	A	B/COM	C	D	E	F	G	L3/COL	L4	L5
A00	\$586	\$616	\$646	\$706	\$761	\$801	\$861	\$761	\$786	\$936
A23	\$681	\$711	\$741	\$801	\$856	\$896	\$956	\$856	\$881	\$1031
A36	\$711	\$741	\$771	\$831	\$886	\$926	\$986	\$886	\$911	\$1061
A37	\$726	\$756	\$786	\$846	\$901	\$941	\$1001	\$901	\$926	\$1076
A46	\$661	\$691	\$721	\$781	\$836	\$876	\$936	\$836	\$861	\$1011

WIDTH: 25.0  
DEPTH: 26.0  
HEIGHT: 38.0-42.5  
SEAT WIDTH: 19.5  
SEAT DEPTH: 18.5  
SEAT HEIGHT: 18.0-22.5  
BACK WIDTH: 17.5  
BACK HEIGHT: 21.5  
COM: .9 YD  
COL: 11.0 LB  
WEIGHT: 34.0 LB

# Neo Lite

## MESH BACK TASK

Webpage



GSA SIN # 33721

### ARM OPTIONS

CODE	DESCRIPTION	PRICE	
<b>A23B</b>	6-Way Height Adjustable Arm • Black	+\$95	
<b>A23G</b>	6-Way Height Adjustable Arm • Graphite Gray	+\$95	
<b>A23W</b>	6-Way Height Adjustable Arm • White	+\$95	
<b>A36</b>	Height Adjustable Pivot/Slide Arm	+\$125	
<b>A37</b>	Height/Width Adjustable Pivot/Slide Arm	+\$140	
<b>A46B</b>	Nylon Loop Arm • Black	+\$75	
<b>A46G</b>	Nylon Loop Arm • Graphite Gray	+\$75	
<b>A46W</b>	Nylon Loop Arm • White	+\$75	

### PLASTIC COLORS

CODE	DESCRIPTION	PRICE
<b>PBK</b>	Black	+\$0
<b>PGG</b>	Graphite Gray	+\$35
<b>PWH</b>	White	+\$35

### MESH COLORS

CODE	DESCRIPTION	PRICE
<b>M31</b>	Graphite Mesh, M3	+\$0
<b>M32</b>	Slate Mesh, M3	+\$35
<b>M33</b>	Snow Mesh, M3	+\$35

### STOOL OPTIONS

CODE	DESCRIPTION	PRICE	
<b>CY30</b>	8" Stool • (Seat Height: 22"-30") • Use for work surfaces up to 36" • Available with Y1	+\$125	
<b>CY36</b>	10" Stool • (Seat Height: 25"-36") • Use for work surfaces up to 42" • Available with Y1	+\$125	

### BASE OPTIONS

CODE	DESCRIPTION	PRICE	
<b>BA11B</b>	27" Mid-Profile Nylon • Black	+\$0	
<b>BA11G</b>	27" Mid-Profile Nylon • Graphite Gray	+\$0	
<b>BA11W</b>	27" Mid-Profile Nylon • White	+\$0	
<b>BA12P</b>	27" Mid-Profile Aluminum Base • Polished	+\$110	
<b>G1</b>	Stationary Base Glide	+\$30	
<b>JB1</b>	Jury Base	+\$300	

### CASTER OPTIONS

CODE	DESCRIPTION	PRICE	
<b>C6</b>	Large Diameter Carpet Casters	+\$0	
<b>C6S</b>	Large Diameter Hard Floor and Carpet Casters	+\$35	
<b>C7</b>	Chrome-Accented Hard Floor and Carpet Casters	+\$35	



# Omnia

ARTISTIC. SIMPLE. BEAUTIFUL.

## ALL MESH

- Conference, collaborative, task and stool seating
- All mesh chair
- Integrated intuitive control
- Aluminum base standard
- Warranted to 300 lbs.

Webpage



GSA SIN # 33721

### MODEL / CONTROL

### MATERIAL

### DIMENSIONS

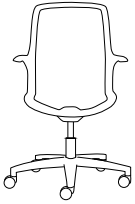

#### 3860 / Z2

Mesh Back - MB &  
Mesh Seat - MS  
Simple Weight-Balanced

- Automatic tension adjustment
- 9° recline or upright tilt lock
- 360° swivel
- Pneumatic cylinder height adjustment

M									
\$1120									



WIDTH: 26.0  
DEPTH: 26.0  
HEIGHT: 37.5-42.5  
SEAT WIDTH: 21.0  
SEAT DEPTH: 18.0  
SEAT HEIGHT: 15.5-20.0  
BACK WIDTH: 18.5  
BACK HEIGHT: 23.0  
COM: N/A  
WEIGHT: 21.0 LB



### PLASTIC AND MESH COLOR

CODE	FRAME	MESH	PRICE
<b>PBK</b>	Black	Midnight	+\$0
<b>PWW</b>	Winter White	Pebble	+\$0

### STOOL OPTIONS

CODE	DESCRIPTION	PRICE	
<b>CY30B</b>	8" Stool • (Seat Height: 22"-30") • Use for work surfaces up to 36"	+\$125	
<b>CY36B</b>	10" Stool • (Seat Height: 25"-36") • Use for work surfaces up to 42"	+\$125	

### BASE OPTIONS

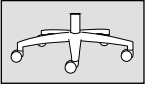
CODE	DESCRIPTION	PRICE	
<b>BA16B</b>	27" Mid-Profile - Black • C7 Chrome-Accented Casters Standard with Polished Base	+\$0	
<b>BA16P</b>	27" Mid-Profile - Polished • C7 Chrome-Accented Casters Standard with Polished Base	+\$0	

### CASTER OPTIONS

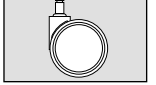
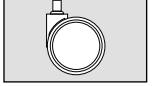
CODE	DESCRIPTION	PRICE	
<b>C6</b>	Large Diameter Carpet Casters	+\$0	
<b>C6S</b>	Large Diameter Hard Floor and Carpet Casters	+\$35	
<b>C7</b>	Chrome-Accented Hard Floor and Carpet Casters	+\$0	



# Shuttle

THE ULTIMATE UTILITY CHAIR

## 4 LEG

- Multipurpose seating, including stacking, side, stools and bariatric
- All plastic, upholstered seat or fully upholstered
- Wall-saver frame on select models
- Plastic back and upholstered back models warranted to 350 lbs., mesh back to 300 lbs., bariatric to 600 lbs.

Webpage



GSA SIN # 33721

### MODEL / CHAIR TYPE

### ARMS MATERIAL

### DIMENSIONS

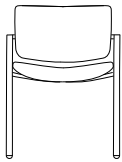

#### 1210 / FRM

Plastic Back - PB & Plastic Seat - PS Stacking

- Non-marring floor glides
- Stacks 4 high on floor
- Stacks 10 high on optional dolly
- Wall-saver frame

	P											
A00	\$388											
A18	\$453											
TRF	\$563											

	ARMLESS	ARMS
WIDTH:	22.0	25.5
DEPTH:	25.0	25.0
HEIGHT:	33.0	33.0
SEAT WIDTH:	19.5	19.5
SEAT DEPTH:	17.0	17.0
SEAT HEIGHT:	17.7	17.7
BACK WIDTH:	20.0	20.0
BACK HEIGHT:	16.0	16.0
COM:	N/A	N/A
COL:	N/A	N/A
WEIGHT:	21.0 LB	24.0 LB

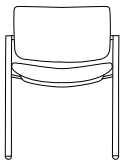

#### 1210 / FRM

Plastic Back - PB & Upholstered Seat - US Stacking

- Non-marring floor glides
- Stacks 4 high on floor
- Stacks 10 high on optional dolly
- Wall-saver frame

	A	B/COM	C	D	E	F	G	L3/COL	L4	L5
A00	\$428	\$453	\$481	\$515	\$573	\$628	\$661	\$538	\$563	\$593
A18	\$493	\$518	\$546	\$580	\$638	\$693	\$726	\$603	\$628	\$658
TRF	\$603	\$628	\$656	\$690	\$748	\$803	\$836	\$713	\$738	\$768

	ARMLESS	ARMS
WIDTH:	22.0	25.5
DEPTH:	25.0	25.0
HEIGHT:	33.0	33.0
SEAT WIDTH:	19.5	19.5
SEAT DEPTH:	17.0	17.0
SEAT HEIGHT:	17.7	17.7
BACK WIDTH:	20.0	20.0
BACK HEIGHT:	16.0	16.0
COM:	1.2 YD	1.2 YD
COL:	N/A	N/A
WEIGHT:	21.0 LB	24.0 LB

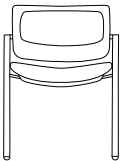

#### 1210 / FRM

Mesh Back - MB & Plastic Seat - PS Stacking

- All mesh styles available M1, M2, M3, M4
- Non-marring floor glides
- Stacks 4 high on floor
- Stacks 10 high on optional dolly
- Wall-saver frame

	P									
A00	\$453									
A18	\$518									
TRF	\$628									

	ARMLESS	ARMS
WIDTH:	22.0	25.5
DEPTH:	25.0	25.0
HEIGHT:	33.0	33.0
SEAT WIDTH:	19.5	19.5
SEAT DEPTH:	17.0	17.0
SEAT HEIGHT:	17.0	17.0
BACK WIDTH:	20.0	20.0
BACK HEIGHT:	16.0	16.0
COM:	N/A	N/A
COL:	N/A	N/A
WEIGHT:	21.0 LB	24.0 LB

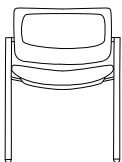

#### 1210 / FRM

Mesh Back - MB & Upholstered Seat - US Stacking

- All mesh styles available M1, M2, M3, M4
- Non-marring floor glides
- Stacks 4 high on floor
- Stacks 10 high on optional dolly
- Wall-saver frame

	A	B/COM	C	D	E	F	G	L3/COL	L4	L5
A00	\$493	\$518	\$546	\$580	\$638	\$693	\$726	\$603	\$628	\$658
A18	\$558	\$583	\$611	\$645	\$703	\$758	\$791	\$668	\$693	\$723
TRF	\$668	\$693	\$721	\$755	\$813	\$868	\$901	\$778	\$803	\$833

	ARMLESS	ARMS
WIDTH:	22.0	25.5
DEPTH:	25.0	25.0
HEIGHT:	33.0	33.0
SEAT WIDTH:	19.5	19.5
SEAT DEPTH:	17.0	17.0
SEAT HEIGHT:	17.0	17.0
BACK WIDTH:	20.0	20.0
BACK HEIGHT:	16.0	16.0
COM:	0.8 YD	0.8 YD
COL:	N/A	N/A
WEIGHT:	21.0 LB	24.0 LB

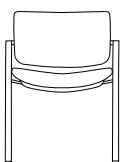

#### 1210 / FRM

Upholstered Back & Upholstered Seat - US Stacking

- Non-marring floor glides
- Stacks 4 high on floor
- Stacks 6 high on optional dolly
- Wall-saver frame

	A	B/COM	C	D	E	F	G	L3/COL	L4	L5
A00	\$483	\$523	\$558	\$618	\$678	\$763	\$818	\$763	\$813	\$933
A18	\$548	\$588	\$623	\$683	\$743	\$828	\$883	\$828	\$878	\$998
TRF	\$658	\$698	\$733	\$793	\$853	\$938	\$993	\$938	\$988	\$1,108

	ARMLESS	ARMS
WIDTH:	22.0	25.5
DEPTH:	25.0	25.0
HEIGHT:	33.0	33.0
SEAT WIDTH:	19.5	19.5
SEAT DEPTH:	17.0	17.0
SEAT HEIGHT:	17.7	17.7
BACK WIDTH:	20.0	20.0
BACK HEIGHT:	16.0	16.0
COM:	1.2 YD	1.2 YD
COL:	N/A	N/A
WEIGHT:	21.0 LB	24.0 LB

# Shuttle

## 4 LEG

Webpage



GSA SIN # 33721

### ARM OPTIONS

CODE	DESCRIPTION	PRICE	
<b>A18B</b>	Soft Touch Polyurethane Arm Black	+\$65	
<b>A18G</b>	Soft Touch Polyurethane Arm Gray	+\$65	
<b>TRF</b>	Right Tablet Arm Available with Black Frame Only Tablet size: 12.5" x 23.25" x .75"	+\$175	

### FRAME COLORS

CODE	DESCRIPTION	PRICE
<b>4LGB</b>	Black	+\$0
<b>4LGS</b>	Silver	+\$0

### PLASTIC COLORS

CODE	DESCRIPTION	PRICE	CODE	DESCRIPTION	PRICE
<b>P01</b>	Black Swan	+\$0	<b>P15</b>	Cloud Gray	+\$0
<b>P05</b>	White Whisper	+\$0	<b>P16</b>	Lagoon Blue	+\$0
<b>P11</b>	Federal Blue	+\$0	<b>P17</b>	Apple Green	+\$0
<b>P12</b>	Crimson Red	+\$0	<b>P18</b>	Tangerine Orange	+\$0
<b>P13</b>	Lemon Yellow	+\$0	<b>P19</b>	Latte	+\$0
<b>P14</b>	Dove Gray	+\$0	<b>P20</b>	Azure Blue	+\$0

### MESH COLORS

CODE	DESCRIPTION	PRICE	CODE	DESCRIPTION	PRICE
<b>M11</b>	Black, M1	+\$0	<b>M33</b>	Snow, M3	+\$30
<b>M12</b>	Gray, M1	+\$0	<b>M40</b>	Latte, M4	+\$30
<b>M13</b>	Silver, M1	+\$0	<b>M41</b>	Cloud, M4	+\$30
<b>M21</b>	Black, M2	+\$30	<b>M42</b>	Lemon, M4	+\$30
<b>M22</b>	Gray, M2	+\$30	<b>M43</b>	Apple, M4	+\$30
<b>M23</b>	White, M2	+\$30	<b>M46</b>	Crimson Red, M4	+\$30
<b>M24</b>	Green, M2	+\$30	<b>M48</b>	Onyx, M4	+\$30
<b>M25</b>	Red, M2	+\$30	<b>M49</b>	Dove, M4	+\$30
<b>M26</b>	Blue, M2	+\$30	<b>M50</b>	Azure, M4	+\$30
<b>M27</b>	Orange, M2	+\$30	<b>M51</b>	Federal Blue, M4	+\$30
<b>M28</b>	Aqua, M2	+\$30	<b>M52</b>	White Whisper, M4	+\$30
<b>M31</b>	Graphite, M3	+\$30			
<b>M32</b>	Slate, M3	+\$30			

### CASTER OPTIONS

CODE	DESCRIPTION	PRICE	
<b>C5</b>	Carpet Casters	+\$45	
<b>C5S</b>	Hard Floor and Carpet Casters	+\$75	

### STOOL OPTIONS

CODE	DESCRIPTION	PRICE	
<b>ST27B</b>	27" Counter Stool • Use for work surfaces up to 36" high • Black	+\$130	
<b>ST27S</b>	27" Counter Stool • Use for work surfaces up to 36" high • Silver	+\$130	
<b>ST30B</b>	30" Bar Stool • Use for work surfaces up to 42" high • Black	+\$150	
<b>ST30S</b>	30" Bar Stool • Use for work surfaces up to 42" high • Silver	+\$150	

### ADDITIONAL OPTIONS

CODE	DESCRIPTION	PRICE	
<b>BN1</b>	Black Ballistic Nylon Back w/ Grade A Fabrics	+\$35	
<b>BN2</b>	Black Ballistic Nylon Back w/ Grade B and Up	+\$50	
<b>EF2</b>	2" Extra Foam on Seat	+\$30	
<b>MFI</b>	1" Visco Elastic Memory Foam on Seat	+\$50	
<b>G19B</b>	Tapered Plastic Glide • Black	+\$0	
<b>G19G</b>	Tapered Plastic Glide • Gray	+\$0	
<b>G19BN</b>	Swivel Nylon Glide • Black Nylon	+\$20	
<b>G19GN</b>	Swivel Nylon Glide • Gray Nylon	+\$20	
<b>G19BS</b>	Swivel Steel Glide • Black Steel	+\$20	
<b>G19GS</b>	Swivel Steel Glide • Gray Steel	+\$20	
<b>G19BF</b>	Swivel Felt Glide • Black Felt	+\$20	
<b>G19GF</b>	Swivel Felt Glide • Gray Felt	+\$20	

### ACCESSORIES

CODE	DESCRIPTION	PRICE	
<b>DL5</b>	Stacking Dolly • Stacks Chairs 10 High	+\$399	
<b>GC1</b>	Ganging Clip • 2 per Set • Armless-to-Armless	+\$30	
<b>GC2</b>	Ganging Clip • 2 per Set • Arm-to-Arm	+\$30	
<b>BRK</b>	Book Rack in Black Only • Available on All Models • Not Stackable with BRK	+\$70	

CAUTION: Careless stacking of chairs may scratch and damage frames. Due to the nature of vinyl upholstery, stacking may cause impressions on the seat. 9to5 Seating does not warrant the effects of the stacking on vinyl upholstery.



# Shuttle

THE ULTIMATE UTILITY CHAIR

## SLED

- Multipurpose seating, including stacking, side, stools and bariatric
- All plastic, upholstered seat or fully upholstered
- Wall-saver frame on select models
- Plastic back and upholstered back models warranted to 350 lbs., mesh back to 300 lbs., bariatric to 600 lbs.

Webpage



GSA SIN # 33721

### MODEL / CHAIR TYPE

### ARMS MATERIAL

### DIMENSIONS

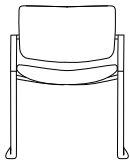

#### 1210 / FRM

##### Plastic Back - PB & Plastic Seat - PS Sled

- Non-marring floor glides
- Wall-saver frame

	P											
A00	\$488											
A18	\$553											

	ARMLESS	ARMS
WIDTH:	22.0	25.5
DEPTH:	25.0	25.0
HEIGHT:	33.0	33.0
SEAT WIDTH:	19.5	19.5
SEAT DEPTH:	17.0	17.0
SEAT HEIGHT:	17.0	17.0
BACK WIDTH:	20.0	20.0
BACK HEIGHT:	16.0	16.0
COM:	N/A	N/A
COL:	N/A	N/A
WEIGHT:	21.0 LB	24.0 LB

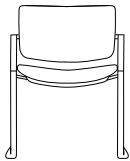

#### 1210 / FRM

##### Plastic Back - PB & Upholstered Seat - US Sled

- Non-marring floor glides
- Wall-saver frame

	A	B/COM	C	D	E	F	G	L3/COL	L4	L5
A00	\$528	\$553	\$581	\$615	\$673	\$728	\$761	\$638	\$663	\$693
A18	\$593	\$618	\$646	\$680	\$738	\$793	\$826	\$703	\$728	\$758

	ARMLESS	ARMS
WIDTH:	22.0	25.5
DEPTH:	25.0	25.0
HEIGHT:	33.0	33.0
SEAT WIDTH:	19.5	19.5
SEAT DEPTH:	17.0	17.0
SEAT HEIGHT:	17.0	17.0
BACK WIDTH:	20.0	20.0
BACK HEIGHT:	16.0	16.0
COM:	1.2 YD	1.2 YD
COL:	N/A	N/A
WEIGHT:	21.0 LB	24.0 LB

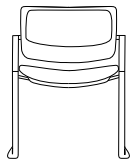

#### 1210 / FRM

##### Mesh Back - MB & Plastic Seat - PS Sled

- All mesh styles available M1, M2, M3, M4
- Non-marring floor glides
- Wall-saver frame

	P											
A00	\$553											
A18	\$618											

	ARMLESS	ARMS
WIDTH:	22.0	25.5
DEPTH:	25.0	25.0
HEIGHT:	33.0	33.0
SEAT WIDTH:	19.5	19.5
SEAT DEPTH:	17.0	17.0
SEAT HEIGHT:	17.0	17.0
BACK WIDTH:	20.0	20.0
BACK HEIGHT:	16.0	16.0
COM:	N/A	N/A
COL:	N/A	N/A
WEIGHT:	21.0 LB	24.0 LB

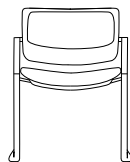

#### 1210 / FRM

##### Mesh Back - MB & Upholstered Seat - US Sled

- All mesh styles available M1, M2, M3, M4
- Non-marring floor glides
- Wall-saver frame

	A	B/COM	C	D	E	F	G	L3/COL	L4	L5
A00	\$593	\$618	\$646	\$680	\$738	\$793	\$826	\$703	\$728	\$758
A18	\$658	\$683	\$711	\$745	\$803	\$858	\$891	\$768	\$793	\$823

	ARMLESS	ARMS
WIDTH:	22.0	25.5
DEPTH:	25.0	25.0
HEIGHT:	33.0	33.0
SEAT WIDTH:	19.5	19.5
SEAT DEPTH:	17.0	17.0
SEAT HEIGHT:	17.0	17.0
BACK WIDTH:	20.0	20.0
BACK HEIGHT:	16.0	16.0
COM:	0.8 YD	0.8 YD
COL:	N/A	N/A
WEIGHT:	23.0 LB	26.0 LB

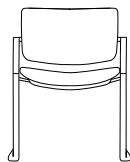

#### 1210 / FRM

##### Upholstered Back & Upholstered Seat - US Sled

- Non-marring floor glides
- Stacks 4 high on floor
- Stacks 6 high on optional dolly
- Wall-saver frame

	A	B/COM	C	D	E	F	G	L3/COL	L4	L5
A00	\$583	\$623	\$658	\$718	\$778	\$863	\$918	\$863	\$913	\$1,033
A18	\$648	\$688	\$723	\$783	\$843	\$928	\$983	\$928	\$978	\$1,098

	ARMLESS	ARMS
WIDTH:	22.0	25.5
DEPTH:	25.0	25.0
HEIGHT:	33.0	33.0
SEAT WIDTH:	19.5	19.5
SEAT DEPTH:	17.0	17.0
SEAT HEIGHT:	19.0	19.0
BACK WIDTH:	20.0	20.0
BACK HEIGHT:	16.0	16.0
COM:	1.2 YD	1.2 YD
COL:	N/A	N/A
WEIGHT:	24.0 LB	27.0 LB

# Shuttle

## SLED

Webpage



GSA SIN # 33721

### ARM OPTIONS

CODE	DESCRIPTION	PRICE
<b>A18B</b>	Soft Touch Polyurethane Arm Black	+\$65
<b>A18G</b>	Soft Touch Polyurethane Arm Gray	+\$65

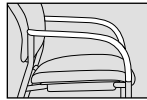

### FRAME COLORS

CODE	DESCRIPTION	PRICE
<b>SLDB</b>	Black	+\$0
<b>SLDS</b>	Silver	+\$0

### PLASTIC COLORS

CODE	DESCRIPTION	PRICE	CODE	DESCRIPTION	PRICE
<b>P01</b>	Black Swan	+\$0	<b>P15</b>	Cloud Gray	+\$0
<b>P05</b>	White Whisper	+\$0	<b>P16</b>	Lagoon Blue	+\$0
<b>P11</b>	Federal Blue	+\$0	<b>P17</b>	Apple Green	+\$0
<b>P12</b>	Crimson Red	+\$0	<b>P18</b>	Tangerine Orange	+\$0
<b>P13</b>	Lemon Yellow	+\$0	<b>P19</b>	Latte	+\$0
<b>P14</b>	Dove Gray	+\$0	<b>P20</b>	Azure Blue	+\$0

### ADDITIONAL OPTIONS

CODE	DESCRIPTION	PRICE
<b>BN1</b>	Black Ballistic Nylon Back w/ Grade A Fabrics	+\$35
<b>BN2</b>	Black Ballistic Nylon Back w/ Grade B and Up	+\$50
<b>EF2</b>	2" Extra Foam on Seat	+\$30
<b>MFI</b>	1" Visco Elastic Memory Foam on Seat	+\$50

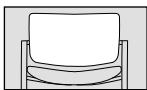
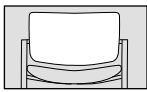

### MESH COLORS

CODE	DESCRIPTION	PRICE	CODE	DESCRIPTION	PRICE
<b>M11</b>	Black, M1	+\$0	<b>M32</b>	Slate, M3	+\$30
<b>M12</b>	Gray, M1	+\$0	<b>M33</b>	Snow, M3	+\$30
<b>M13</b>	Silver, M1	+\$0	<b>M40</b>	Latte, M4	+\$30
<b>M21</b>	Black, M2	+\$30	<b>M41</b>	Cloud, M4	+\$30
<b>M22</b>	Gray, M2	+\$30	<b>M42</b>	Lemon, M4	+\$30
<b>M23</b>	White, M2	+\$30	<b>M43</b>	Apple, M4	+\$30
<b>M24</b>	Green, M2	+\$30	<b>M46</b>	Crimson Red, M4	+\$30
<b>M25</b>	Red, M2	+\$30	<b>M48</b>	Onyx, M4	+\$30
<b>M26</b>	Blue, M2	+\$30	<b>M49</b>	Dove, M4	+\$30
<b>M27</b>	Orange, M2	+\$30	<b>M50</b>	Azure, M4	+\$30
<b>M28</b>	Aqua, M2	+\$30	<b>M51</b>	Federal Blue, M4	+\$30
<b>M31</b>	Graphite, M3	+\$30	<b>M52</b>	White Whisper, M4	+\$30

### ACCESSORIES

CODE	DESCRIPTION	PRICE
<b>GC1</b>	Ganging Clip • 2 per Set • Armless-to-Armless	+\$30
<b>GC2</b>	Ganging Clip • 2 per Set • Arm-to-Arm	+\$30



CAUTION: Careless stacking of chairs may scratch and damage frames. Due to the nature of vinyl upholstery, stacking may cause impressions on the seat. 9to5 Seating does not warrant the effects of the stacking on vinyl upholstery.



# Shuttle

THE ULTIMATE UTILITY CHAIR

## BARIATRIC

- Multipurpose seating, including stacking, side, stools and bariatric
- All plastic, upholstered seat or fully upholstered
- Wall-saver frame on select models
- Plastic back and upholstered back models warranted to 350 lbs., mesh back to 300 lbs., bariatric to 600 lbs.

Webpage



GSA SIN # 33721

### MODEL / CHAIR TYPE

### ARMS MATERIAL

### DIMENSIONS

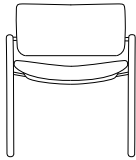

#### 1250 / FRM

Upholstered Back - UB  
& Upholstered Seat - US  
Bariatric

- Steel reinforced seat and back
- 30" wide seat
- Does not stack
- Warranted to 600 lbs.

	A	B/COM	C	D	E	F	G
A18	\$991	\$1,061	\$1,106	\$1,176	\$1,256	\$1,346	\$1,446

#### ARMS

WIDTH:	36.5
DEPTH:	25.0
HEIGHT:	33.0
SEAT WIDTH:	31.0
SEAT DEPTH:	17.0
SEAT HEIGHT:	19.0
BACK WIDTH:	30.0
BACK HEIGHT:	16.0
COM:	2.1 YD
COL:	N/A
WEIGHT:	32.0 LB

# Shuttle

## BARIATRIC

Webpage



GSA SIN # 33721

### ARM OPTIONS

CODE	DESCRIPTION	PRICE
<b>A18B</b>	Soft Touch Polyurethane Arm Black	+\$65
<b>A18G</b>	Soft Touch Polyurethane Arm Gray	+\$65

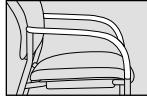

### FRAME COLORS

CODE	DESCRIPTION	PRICE
<b>4LGB</b>	Black	+\$0
<b>4LGS</b>	Silver	+\$0

### ACCESSORIES

CODE	DESCRIPTION	PRICE
<b>GC2</b>	Ganging Clip • 2 per Set • Arm-to-Arm	+\$30

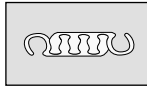

### ADDITIONAL OPTIONS

CODE	DESCRIPTION	PRICE
<b>G18</b>	Dome Glide	+\$0
<b>G8</b>	Swivel Steel Glide • 4 per Set	+\$20
<b>G9</b>	Swivel Nylon Glide • 4 per Set	+\$20
<b>G10</b>	Swivel Felt Glide • 4 per Set	+\$20
<b>BN1</b>	Black Ballistic Nylon Back w/ Grade A Fabrics	+\$35
<b>BN2</b>	Black Ballistic Nylon Back w/ Grade B and Up	+50
<b>EF2</b>	2" Extra Foam on Seat	+\$30
<b>MFI</b>	1" Visco Elastic Memory Foam on Seat	+\$50

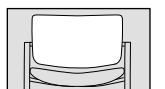
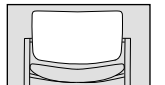
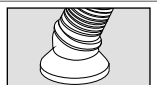
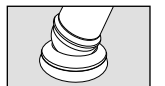
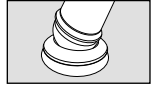
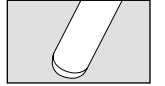



# Sol

THE FUTURE AT A GLANCE

## MESH BACK & UPHOLSTERED BACK

- Task, executive and conference seating
- Innovative design supports back, shoulders and arms without limiting range of motion
- Mesh or upholstered back options
- Integrated height-adjustable lumbar and seat slider standard
- Warranted to 300 lbs.

Webpage



GSA SIN # 33721

### MODEL / CONTROL

### ARMS MATERIAL

### DIMENSIONS

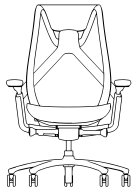

#### 3680 / Y6

#### Mesh Back - MB Deluxe Synchro

- Integrated seat slider
- 4-position tilt lock
- Side knob tension adjustment with 7 settings
- 2:1 back-to-seat tilt ratio
- 360° swivel
- Pneumatic cylinder height adjustment

	A	B/COM	C	D	E	F	G	L3/COL	L4	L5
A48P	\$1558	\$1588	\$1618	\$1668	\$1718	\$1768	\$1833	\$1783	\$1808	\$1908

WIDTH: 28.0  
 DEPTH: 28.0  
 HEIGHT: 39.5-44.0  
 SEAT WIDTH: 19.0  
 SEAT DEPTH: 16.5-19.0  
 SEAT HEIGHT: 16.5-21.0  
 BACK WIDTH: 18.5  
 BACK HEIGHT: 25.0  
 COM: 0.9 YD  
 COL: 16.0 SQ FT  
 WEIGHT: 50.0 LB

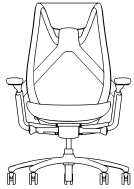

#### 3680 / Y6

#### Upholstered Back - UB Deluxe Synchro

- Integrated seat slider
- 4-position tilt lock
- Side knob tension adjustment with 7 settings
- 2:1 back-to-seat tilt ratio
- 360° swivel
- Pneumatic cylinder height adjustment

	A	B/COM	C	D	E	F	G	L3/COL	L4	L5
A48P	\$1645	\$1725	\$1780	\$1855	\$1955	\$2055	\$2170	\$1880	\$1960	\$2240

WIDTH: 28.0  
 DEPTH: 28.0  
 HEIGHT: 39.5-44.0  
 SEAT WIDTH: 19.0  
 SEAT DEPTH: 16.5-19.0  
 SEAT HEIGHT: 16.5-21.0  
 BACK WIDTH: 18.5  
 BACK HEIGHT: 25.0  
 COM: 2.2 YD  
 COL: 32.0 SQ FT  
 WEIGHT: 50.0 LB

# Sol

## MESH BACK & UPHOLSTERED BACK

Webpage



GSA SIN # 33721

### ARM OPTIONS

CODE	DESCRIPTION	PRICE
<b>A48P</b>	6-Way Height-Adjustable Arm w/ Sliding Pad • Polished	+\$0

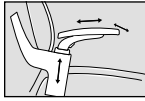

### BASE OPTIONS

CODE	DESCRIPTION	PRICE
<b>BA26B</b>	27" Low Profile Nylon Base • Black	-\$50
<b>BA36P</b>	27" Low Profile Aluminum Base • Polished	+\$0
<b>BA36S</b>	27" Low Profile Aluminum Base • Silver	+\$0

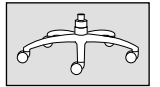
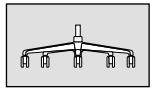

### FRAME COLORS

CODE	DESCRIPTION	PRICE
<b>TSKS</b>	Silver • Comes with polished aluminum arms	+\$0
<b>TSKP</b>	Polished • Comes with polished aluminum arms	+\$0

### CASTER OPTIONS

CODE	DESCRIPTION	PRICE
<b>C6</b>	Large Diameter Carpet Casters	+\$0
<b>C6S</b>	Large Diameter Hard Floor and Carpet Casters	+\$35
<b>C7</b>	Chrome-Accented Hard Floor and Carpet Casters	+\$0

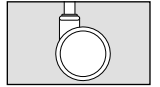

### MESH COLORS

CODE	DESCRIPTION	PRICE	CODE	DESCRIPTION	PRICE
<b>M21</b>	Black, M2	+\$0	<b>M41</b>	Cloud, M4	+\$0
<b>M22</b>	Gray, M2	+\$0	<b>M42</b>	Lemon, M4	+\$0
<b>M23</b>	White, M2	+\$0	<b>M43</b>	Apple, M4	+\$0
<b>M24</b>	Green, M2	+\$0	<b>M46</b>	Crimson, M4	+\$0
<b>M25</b>	Red, M2	+\$0	<b>M48</b>	Onyx, M4	+\$0
<b>M26</b>	Blue, M2	+\$0	<b>M49</b>	Dove, M4	+\$0
<b>M27</b>	Orange, M2	+\$0	<b>M50</b>	Azure, M4	+\$0
<b>M28</b>	Aqua, M2	+\$0	<b>M51</b>	Federal Blue, M4	+\$0
<b>M40</b>	Latte, M4	+\$0	<b>M52</b>	White Whisper, M4	+\$0



# Sophie

ULTIMATE COMFORT IN A COMPLETE LINE OF LOUNGE SEATING

## LOUNGE

- Lounge collection, including guest, multi-seat, bariatric, bench and tables
- Robust steel frame construction for high-traffic areas
- Cleanout space and wall-saver frame on selected models
- Field replaceable parts and arm caps
- Silver and black frame finishes
- Warranted to 350+ lbs.



Webpage

GSA SIN # 33721

### MODEL / CONTROL

### ARMS MATERIAL

### DIMENSIONS

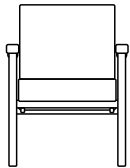

#### 8111

##### Single Guest

- Wall-saver frame
- Soft-touch urethane arm pads
- Non-marring adjustable glides
- Warranted to 350 lbs.

	A	B/COM	C	D	E	F	G	L3/COL	L4	L5
A80B/G	\$1,191	\$1,251	\$1,336	\$1,431	\$1,541	\$1,641	\$1,791	\$1,666	\$1,741	\$1,916

WIDTH: 25.0  
 DEPTH: 27.5  
 HEIGHT: 34.0  
 SEAT WIDTH: 20.0  
 SEAT DEPTH: 19.0  
 SEAT HEIGHT: 18.0  
 BACK WIDTH: 20.0  
 BACK HEIGHT: 19.0  
 COM: 1.7 YD  
 COL: 35.0 SQ FT  
 WEIGHT: 56.0 LB

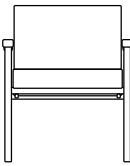

#### 8119

##### Bariatric

- Wall-saver frame
- Soft-touch urethane arm pads
- Non-marring adjustable glides
- Warranted to 500 lbs.

	A	B/COM	C	D	E	F	G	L3/COL	L4	L5
A80B/G	\$1,491	\$1,586	\$1,696	\$1,816	\$1,976	\$2,116	\$2,241	\$1,966	\$2,241	\$2,451

WIDTH: 35.0  
 DEPTH: 27.5  
 HEIGHT: 34.0  
 SEAT WIDTH: 30.0  
 SEAT DEPTH: 19.0  
 SEAT HEIGHT: 18.0  
 BACK WIDTH: 29.0  
 BACK HEIGHT: 19.0  
 COM: 2.7 YD  
 COL: 40.0 SQ FT  
 WEIGHT: 66.0 LB

# Sophie

## LOUNGE



GSA SIN # 33721

### ARM OPTIONS

CODE	DESCRIPTION	PRICE
<b>A80B</b>	Soft Touch Pad • Black	+\$0
<b>A80G</b>	Soft Touch Pad • Gray	+\$0

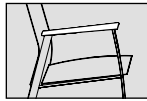

### FRAME COLORS

CODE	DESCRIPTION	PRICE
<b>4LGB</b>	Black	+\$0
<b>4LGS</b>	Silver	+\$0

### ADDITIONAL OPTIONS

CODE	DESCRIPTION	PRICE
<b>8199</b>	Large Ganging Bracket	+\$99
<b>TT</b>	Two Tone Contrasting Upholstery (seat and back) • * If the two upholstery selections are of different grades, the chair will price at the higher of the two grades.	+100*

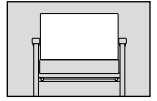
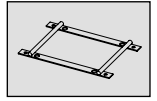



# Sophie

ULTIMATE COMFORT IN A COMPLETE LINE OF LOUNGE SEATING

## LOUNGE

- Lounge collection, including guest, multi-seat, bariatric, bench and tables
- Robust steel frame construction for high-traffic areas
- Cleanout space and wall-saver frame on selected models
- Field replaceable parts and arm caps
- Silver and black frame finishes
- Warranted to 350+ lbs.

Webpage



GSA SIN # 33721

### MODEL / CONTROL

### ARMS MATERIAL

### DIMENSIONS

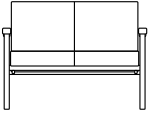
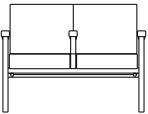
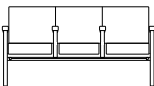
MODEL / CONTROL	ARMS	MATERIAL	A	B/COM	C	D	E	F	G	L3/COL	L4	L5	DIMENSIONS
 <p><b>8112</b> Double Seat W/ Outside Arms</p> <ul style="list-style-type: none"> <li>• Wall-saver frame</li> <li>• Outer armrests feature soft-touch urethane arm pads</li> <li>• Non-marring adjustable glides</li> <li>• Warranted to 525 lbs.</li> </ul>	A80B/G		\$1,888	\$2,008	\$2,148	\$2,323	\$2,503	\$2,713	\$3,013	\$2,513	\$2,788	\$3,288	WIDTH: 46.0 DEPTH: 27.5 HEIGHT: 34.0 SEAT WIDTH: 20.0 SEAT DEPTH: 19.0 SEAT HEIGHT: 18.0 BACK WIDTH: 20.0 BACK HEIGHT: 19.0 COM: 3.0 YD COL: 70.0 YD WEIGHT: 87.0 LB
 <p><b>8122</b> Double Seat W/ Center Arms</p> <ul style="list-style-type: none"> <li>• Wall-saver frame</li> <li>• Outer and inner armrests feature soft-touch urethane arm pads</li> <li>• Non-marring adjustable glides</li> <li>• Warranted to 525 lbs.</li> </ul>	A80B/G		\$2,009	\$2,129	\$2,269	\$2,444	\$2,624	\$2,834	\$3,134	\$2,634	\$2,909	\$3,409	WIDTH: 47.5 DEPTH: 27.5 HEIGHT: 34.0 SEAT WIDTH: 20.5 SEAT DEPTH: 19.0 SEAT HEIGHT: 18.0 BACK WIDTH: 20.0 BACK HEIGHT: 19.0 COM: 3.0 YD COL: 70.0 YD WEIGHT: 95.0 LB
 <p><b>8123</b> Triple Seat W/ Center Arms</p> <ul style="list-style-type: none"> <li>• Wall-saver frame</li> <li>• Outer and inner armrests feature soft-touch urethane arm pads</li> <li>• Non-marring adjustable glides</li> <li>• Warranted to 750 lbs.</li> </ul>	A80B/G		\$2,779	\$2,959	\$3,179	\$3,379	\$3,694	\$3,974	\$4,289	\$3,404	\$4,029	\$4,629	WIDTH: 70.0 DEPTH: 27.5 HEIGHT: 34.0 SEAT WIDTH: 20.5 SEAT DEPTH: 19.0 SEAT HEIGHT: 18.0 BACK WIDTH: 20.0 BACK HEIGHT: 19.0 COM: 4.4 YD COL: 105.0 YD WEIGHT: 136.0 LB

# Sophie

## LOUNGE

Webpage



GSA SIN # 33721

### ARM OPTIONS

CODE	DESCRIPTION	PRICE
<b>A80B</b>	Soft Touch Pad • Black	+\$60
<b>A80G</b>	Soft Touch Pad • Gray	+\$60

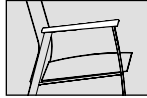

### FRAME COLORS

CODE	DESCRIPTION	PRICE
<b>4LGB</b>	Black	+\$0
<b>4LGS</b>	Silver	+\$0

### ADDITIONAL OPTIONS

CODE	DESCRIPTION	PRICE
<b>8199</b>	Large Ganging Bracket	+\$99
<b>TT</b>	Two Tone Contrasting Upholstery (seat and back) • * If the two upholstery selections are of different grades, the chair will price at the higher of the two grades.	+100*

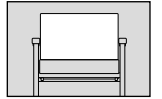
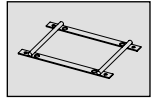



# Sophie

ULTIMATE COMFORT IN A COMPLETE LINE OF LOUNGE SEATING

## LOUNGE BENCHES

- Lounge collection, including guest, multi-seat, bariatric, bench and tables
- Robust steel frame construction for high-traffic areas
- Cleanout space and wall-saver frame on selected models
- Field replaceable parts and arm caps
- Silver and black frame finishes
- Warranted to 350+ lbs.



GSA SIN # 33721

### MODEL / CONTROL

### MATERIAL

### DIMENSIONS



#### 8103

##### Triple Bench

- Three-seat bench
- Non-marring adjustable glides
- Warranted to 750 lbs.

A	B/COM	C	D	E	F	G	L3/COL	L4	L5
\$1,908	\$2,018	\$2,118	\$2,253	\$2,408	\$2,533	\$2,678	\$2,493	\$2,608	\$2,908

WIDTH: 61.5  
 DEPTH: 23.5  
 HEIGHT: 18.0  
 SEAT WIDTH: 20.5  
 SEAT DEPTH: 23.5  
 SEAT HEIGHT: 18.0  
 BACK WIDTH: N/A  
 BACK HEIGHT: N/A  
 COM: 2.3 YD  
 COL: N/A  
 WEIGHT: 62.0 LB

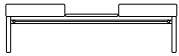

#### 8104

##### Double Bench W/ Table Top

- Two-seat bench with center tabletop
- Non-marring adjustable glides
- Warranted to 525 lbs.

A	B/COM	C	D	E	F	G	L3/COL	L4	L5
\$1,806	\$1,871	\$1,941	\$2,026	\$2,131	\$2,206	\$2,306	\$2,206	\$2,281	\$2,481

WIDTH: 61.5  
 DEPTH: 23.5  
 HEIGHT: 18.0  
 SEAT WIDTH: 20.5  
 SEAT DEPTH: 23.5  
 SEAT HEIGHT: 18.0  
 BACK WIDTH: N/A  
 BACK HEIGHT: N/A  
 COM: 1.8 YD  
 COL: N/A  
 WEIGHT: 62.0 LB

# Sophie

## LOUNGE BENCHES

Webpage



GSA SIN # 33721

### FRAME COLORS

CODE	DESCRIPTION	PRICE
<b>4LGB</b>	Black	+\$0
<b>4LGS</b>	Silver	+\$0

### LAMINATE COLORS

CODE	DESCRIPTION	PRICE
<b>BKL</b>	Black	+\$0
<b>DWL</b>	Designer White	+\$0
<b>PTL</b>	Platinum	+\$0



# Sophie

ULTIMATE COMFORT IN A COMPLETE LINE OF LOUNGE SEATING

## LOUNGE TABLES

- Stand-alone and linking tables that complement Sophie seating
- Silver and black frame finishes
- Three laminate colors
- Tables ship knocked down (KD)



Webpage

GSA SIN # 33721

### MODEL / CONTROL

### TABLE

### DIMENSIONS

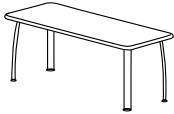

**8170**  
Stand-Alone 22" X 42"  
Rectangular

- Two stand-alone table sizes
- Three laminate colors
- Two frame colors

\$835

WIDTH: 22.0  
DEPTH: 42.0  
HEIGHT: 17.0



**8190**  
Stand-Alone 24"  
Square

- Two stand-alone table sizes
- Three laminate colors
- Two frame colors

\$692

WIDTH: 24.0  
DEPTH: 24.0  
HEIGHT: 17.0



**8191**  
Connecting 24"  
End-of-Run

- End-of-run table
- Three laminate colors
- Two frame colors
- Linking tables are not intended for use with bench models (8103 & 8104)

\$704

WIDTH: 24.0  
DEPTH: 24.0  
HEIGHT: 13.5

# Sophie

## LOUNGE TABLES

Webpage



GSA SIN # 33721

### FRAME COLORS

CODE	DESCRIPTION	PRICE
<b>4LGB</b>	Black	+\$0
<b>4LGS</b>	Silver	+\$0

### LAMINATE COLORS

CODE	DESCRIPTION	PRICE
<b>BKL</b>	Black	+\$0
<b>DWL</b>	Designer White	+\$0
<b>PTL</b>	Platinum	+\$0



# Strata

LET STRATA FLOAT INTO YOUR OFFICE

## MESH BACK UPHOLSTERED SEAT

- Task, stool, conference and executive seating
- Aluminum frame and base
- Mesh or upholstered seat
- Height- and depth-adjustable lumbar
- standard
- Heavy duty multi-shift 24/7 optional (350 lb. rating)
- Warranted to 300 lbs.



GSA SIN # 33721

### MODEL / CONTROL

### ARMS MATERIAL

### DIMENSIONS



#### 1560 / Y2

#### Mesh Back - MB & Upholstered Seat - US Heavy Duty Synchro Tilt

- 4-position tilt lock
- Side knob tension adjustment
- 2:1 back-to-seat tilt ratio
- 360° swivel
- Pneumatic cylinder height adjustment

	T01	A	B/COM	C	D	E	F	G	L3/COL	L4	L5
A00	\$890	\$941	\$971	\$1001	\$1061	\$1116	\$1156	\$1216	\$1141	\$1191	\$1291
A6	\$1050	\$1101	\$1131	\$1161	\$1221	\$1276	\$1316	\$1376	\$1301	\$1351	\$1451
A7	\$1065	\$1116	\$1146	\$1176	\$1236	\$1291	\$1331	\$1391	\$1316	\$1366	\$1466
A8B/S	\$995	\$1046	\$1076	\$1106	\$1166	\$1221	\$1261	\$1321	\$1246	\$1296	\$1396
A9B/S	\$1005	\$1056	\$1086	\$1116	\$1176	\$1231	\$1271	\$1331	\$1256	\$1306	\$1406
A10	\$1000	\$1051	\$1081	\$1111	\$1171	\$1226	\$1266	\$1326	\$1251	\$1301	\$1401
A36	\$1015	\$1066	\$1096	\$1126	\$1186	\$1241	\$1281	\$1341	\$1266	\$1316	\$1416
A37	\$1030	\$1081	\$1111	\$1141	\$1201	\$1256	\$1296	\$1356	\$1281	\$1331	\$1431

WIDTH: 26.5  
 DEPTH: 26.5  
 HEIGHT: 39.5-44.0  
 SEAT WIDTH: 21.0  
 SEAT DEPTH: 18.0  
 SEAT HEIGHT: 17.0-21.5  
 SEAT HEIGHT W/  
 SEAT SLIDER: 18.0-22.5  
 BACK WIDTH: 21.0  
 BACK HEIGHT: 22.0  
 COM: 0.9 YD  
 COL: 11.0 SQ FT  
 WEIGHT: 50.0 LB



#### 1560 / Y2

#### Mesh Back - MB & Mesh Seat - MS Heavy Duty Synchro Tilt

- 4-position tilt lock
- Side knob tension adjustment
- 2:1 back-to-seat tilt ratio
- 360° swivel
- Pneumatic cylinder height adjustment

	M										
A00	\$941										
A6	\$1101										
A7	\$1116										
A8B/S	\$1046										
A9B/S	\$1056										
A10	\$1051										
A36	\$1066										
A37	\$1081										

WIDTH: 26.5  
 DEPTH: 26.5  
 HEIGHT: 39.5-44.0  
 SEAT WIDTH: 19.0  
 SEAT DEPTH: 18.0  
 SEAT HEIGHT: 17.0-21.5  
 SEAT HEIGHT W/  
 SEAT SLIDER: 18.0-22.5  
 BACK WIDTH: 21.5  
 BACK HEIGHT: 23.0  
 COM: N/A  
 COL: N/A  
 WEIGHT: 50.0 LB

# Strata

## MESH BACK UPHOLSTERED SEAT

Webpage



GSA SIN # 33721

### ARM OPTIONS

CODE	DESCRIPTION	PRICE	
<b>A6</b>	Height Adjustable Pivot Slide Arm	+\$160	
<b>A7</b>	Height Adjustable Pivot Slide Arm	+\$175	
<b>A8B</b>	Height Adjustable Arm • Black	+\$105	
<b>A8S</b>	Height Adjustable Arm • Silver	+\$105	
<b>A9B</b>	Height/Width Adjustable Arm • Black	+\$115	
<b>A9S</b>	Height/Width Adjustable Arm • Silver	+\$115	
<b>A10</b>	Soft Touch C-Shaped Arm	+\$110	
<b>A36</b>	Height Adjustable Pivot/Slide Arm	+\$125	
<b>A37</b>	Height/Width Adjustable Pivot/Slide Arm	+\$140	
<b>A90</b>	Height/Width Adjustable Breakaway Arm	+\$240	

### FRAME OPTIONS

CODE	DESCRIPTION	PRICE
<b>TSKB</b>	• Black	+\$0
<b>TSKS</b>	• Silver	+\$0

### STOOL OPTIONS

CODE	DESCRIPTION	PRICE	
<b>CY30</b>	8" Stool • (Seat Height: 22"-30") • Use for work surfaces up to 36"	+\$125	
<b>CY36</b>	10" Stool • (Seat Height: 25"-36") • Use for work surfaces up to 42"	+\$125	

### BASE OPTIONS

CODE	DESCRIPTION	PRICE	
<b>BA2B</b>	26" Aluminum Base • Black	+\$0	
<b>BA2S</b>	26" Aluminum Base • Silver	+\$0	

### CASTER OPTIONS

CODE	DESCRIPTION	PRICE	
<b>C4</b>	Heavy Duty Hard Wood Floor and Carpet Casters	+\$0	
<b>C1S</b>	Hard Floor and Carpet Casters	+\$35	
<b>C2S</b>	Decompression Hard Floor and Soft Carpet Casters	+\$35	

### ADDITIONAL OPTIONS

CODE	DESCRIPTION	PRICE	
<b>HD</b>	Heavy Duty Multi-Shift • Upgrade 350 lb. (includes BA2 Aluminum Base and C4 60mm Heavy Duty Casters)	+\$50	
<b>HR1</b>	Headrest • Pricing applies to any fabric grade	+\$75	
<b>SS</b>	Seat Slider 2.5" for Y1 • Factory Installed • Not available on stool models	+\$60	



# Strata Lite

LET STRATA FLOAT  
INTO YOUR OFFICE

## MESH BACK UPHOLSTERED SEAT

- Task, stool, conference and executive seating
- Nylon frame and base
- Mesh or upholstered seat
- Height- and depth-adjustable lumbar
- standard
- Warranted to 300 lbs.

Webpage



GSA SIN # 33721

### MODEL / CONTROL

### ARMS MATERIAL

### DIMENSIONS



#### 1545 / Y1

#### Mesh Back - MB & Upholstered Seat - US Simple Synchro Tilt

- Upright tilt lock
- 3:1 back-to-seat tilt ratio
- Center knob tension adjustment
- 360° swivel
- Pneumatic cylinder height adjustment

	T01	A	B/COM	C	D	E	F	G	L3/COL	L4	L5
A00	\$788	\$839	\$869	\$899	\$959	\$1014	\$1054	\$1114	\$1039	\$1089	\$1189
A6	\$948	\$999	\$1029	\$1059	\$1119	\$1174	\$1214	\$1274	\$1199	\$1249	\$1349
A7	\$963	\$1014	\$1044	\$1074	\$1134	\$1189	\$1229	\$1289	\$1214	\$1264	\$1364
A8B/S	\$893	\$944	\$974	\$1004	\$1064	\$1119	\$1159	\$1219	\$1144	\$1194	\$1294
A9B/S	\$903	\$954	\$984	\$1014	\$1074	\$1129	\$1169	\$1229	\$1154	\$1204	\$1304
A10	\$898	\$949	\$979	\$1009	\$1069	\$1124	\$1164	\$1224	\$1149	\$1199	\$1299
A36	\$913	\$964	\$994	\$1024	\$1084	\$1139	\$1179	\$1239	\$1164	\$1214	\$1314
A37	\$928	\$979	\$1009	\$1039	\$1099	\$1154	\$1194	\$1254	\$1179	\$1229	\$1329

WIDTH: 26.5  
DEPTH: 26.5  
HEIGHT: 39.5-44.0  
SEAT WIDTH: 21.0  
SEAT DEPTH: 18.0  
SEAT HEIGHT: 17.0-21.5  
SEAT HEIGHT W/  
SEAT SLIDER: 18.0-22.5  
BACK WIDTH: 21.0  
BACK HEIGHT: 22.0  
COM: 0.9 YD  
COL: 11.0 SQ FT  
WEIGHT: 46.0 LB



#### 1545 / Y4

#### Mesh Back - MB & Upholstered Seat - US Intensive Synchro Tilt

- Integrated seat slider
- 4-position tilt lock
- 5° forward tilt
- Side knob tension adjustment
- 2:1 back-to-seat tilt ratio
- 360° swivel
- Pneumatic cylinder height adjustment

	T01	A	B/COM	C	D	E	F	G	L3/COL	L4	L5
A00	\$878	\$929	\$959	\$989	\$1049	\$1104	\$1144	\$1204	\$1129	\$1179	\$1279
A6	\$1038	\$1089	\$1119	\$1149	\$1209	\$1264	\$1304	\$1364	\$1289	\$1339	\$1439
A7	\$1053	\$1104	\$1134	\$1164	\$1224	\$1279	\$1319	\$1379	\$1304	\$1354	\$1454
A8B/S	\$983	\$1034	\$1064	\$1094	\$1154	\$1209	\$1249	\$1309	\$1234	\$1284	\$1384
A9B/S	\$993	\$1044	\$1074	\$1104	\$1164	\$1219	\$1259	\$1319	\$1244	\$1294	\$1394
A10	\$988	\$1039	\$1069	\$1099	\$1159	\$1214	\$1254	\$1314	\$1239	\$1289	\$1389
A36	\$1003	\$1054	\$1084	\$1114	\$1174	\$1229	\$1269	\$1329	\$1254	\$1304	\$1404
A37	\$1018	\$1069	\$1099	\$1129	\$1189	\$1244	\$1284	\$1344	\$1269	\$1319	\$1419

WIDTH: 26.5  
DEPTH: 26.5  
HEIGHT: 39.5-44.0  
SEAT WIDTH: 21.0  
SEAT DEPTH: 18.0  
SEAT HEIGHT: 18.0-21.0  
BACK WIDTH: 21.0  
BACK HEIGHT: 22.0  
COM: 0.9 YD  
COL: 11.0 SQ FT  
WEIGHT: 46.0 LB

# Strata Lite

## MESH BACK UPHOLSTERED SEAT

Webpage



GSA SIN # 33721

### ARM OPTIONS

CODE	DESCRIPTION	PRICE	
<b>A6</b>	Height Adjustable Pivot Slide Arm	+\$160	
<b>A7</b>	Height/Width Adjustable Pivot Slide Arm	+\$175	
<b>A8B</b>	Height Adjustable Arm • Black	+\$105	
<b>A8S</b>	Height Adjustable Arm • Silver	+\$105	
<b>A9B</b>	Height/Width Adjustable Arm • Black	+\$115	
<b>A9S</b>	Height/Width Adjustable Arm • Silver	+\$115	
<b>A10</b>	Soft Touch C-Shaped Arm	+\$110	
<b>A36</b>	Height Adjustable Pivot/Slide Arm	+\$125	
<b>A37</b>	Height/Width Adjustable Pivot/Slide Arm	+\$140	
<b>A90</b>	Height/Width Adjustable Breakaway Arm	+\$240	

### BASE OPTIONS

CODE	DESCRIPTION	PRICE	
<b>BA1B</b>	26" Nylon Base • Black	+\$0	
<b>BA2B</b>	26" Aluminum Base • Black	+\$110	
<b>BA2S</b>	26" Aluminum Base • Silver	+\$110	

### STOOL OPTIONS

CODE	DESCRIPTION	PRICE	
<b>CY30</b>	8" Stool • Seat Height: 22"-30" • Use for work surfaces up to 36" • Available with Y1	+\$125	
<b>CY36</b>	10" Stool • Seat Height: 25"-36" • Use for work surfaces up to 42" • Available with Y1	+\$125	

### CASTER OPTIONS

CODE	DESCRIPTION	PRICE	
<b>C4</b>	Heavy Duty Hard Wood Floor and Carpet Casters	+\$0	
<b>C1S</b>	Hard Floor and Carpet Casters	+\$35	
<b>C2S</b>	Decompression Hard Floor and Soft Carpet Casters	+\$35	

### ADDITIONAL OPTIONS

CODE	DESCRIPTION	PRICE	
<b>HR1</b>	Headrest • Pricing applies to any fabric grade	+\$75	
<b>SS</b>	Seat Slider 2.5" • Factory Installed • Not available on stool models	+\$60	



# Strata Lite

LET STRATA FLOAT  
INTO YOUR OFFICE

## ALL MESH

- Task, stool, conference and executive seating
- Nylon frame and base
- Mesh or upholstered seat
- Height- and depth-adjustable lumbar
- standard
- Warranted to 300 lbs.

Webpage



GSA SIN # 33721

### MODEL / CONTROL

### ARMS

### MATERIAL

### DIMENSIONS



#### 1545 / Y1

#### Mesh Back - MB & Mesh Seat - MS Simple Synchro Tilt

- Upright tilt lock
- 3:1 back-to-seat tilt ratio
- Center knob tension adjustment
- 360° swivel
- Pneumatic cylinder height adjustment

		M											
A00	\$824												
A6	\$984												
A7	\$999												
A8B/S	\$929												
A9B/S	\$939												
A10	\$934												
A36	\$949												
A37	\$964												

WIDTH: 26.5  
DEPTH: 26.5  
HEIGHT: 39.5-44.0  
SEAT WIDTH: 21.0  
SEAT DEPTH: 18.0  
SEAT HEIGHT: 17.0-21.5  
SEAT HEIGHT W/  
SEAT SLIDER: 18.0-22.5  
BACK WIDTH: 21.0  
BACK HEIGHT: 22.0  
COM: 0.9 YD  
COL: 11.0 SQ FT  
WEIGHT: 46.0 LB



#### 1545 / Y4

#### Mesh Back - MB & Mesh Seat - MS Intensive Synchro Tilt

- Integrated seat slider
- 4-position tilt lock
- 5° forward tilt
- Side knob tension adjustment
- 2:1 back-to-seat tilt ratio
- 360° swivel
- Pneumatic cylinder height adjustment

		M											
A00	\$914												
A6	\$1074												
A7	\$1089												
A8B/S	\$1019												
A9B/S	\$1029												
A10	\$1024												
A36	\$1039												
A37	\$1054												

WIDTH: 26.5  
DEPTH: 26.5  
HEIGHT: 39.5-44.0  
SEAT WIDTH: 21.0  
SEAT DEPTH: 18.0  
SEAT HEIGHT: 18.0-21.0  
BACK WIDTH: 21.0  
BACK HEIGHT: 22.0  
COM: 0.9 YD  
COL: 11.0 SQ FT  
WEIGHT: 46.0 LB

# Strata Lite

## ALL MESH

Webpage



GSA SIN # 33721

### ARM OPTIONS

CODE	DESCRIPTION	PRICE	
<b>A6</b>	Height Adjustable Pivot Slide Arm	+\$160	
<b>A7</b>	Height/Width Adjustable Pivot Slide Arm	+\$175	
<b>A8B</b>	Height Adjustable Arm • Black	+\$105	
<b>A8S</b>	Height Adjustable Arm • Silver	+\$105	
<b>A9B</b>	Height/Width Adjustable Arm • Black	+\$115	
<b>A9S</b>	Height/Width Adjustable Arm • Silver	+\$115	
<b>A10</b>	Soft Touch C-Shaped Arm	+\$110	
<b>A36</b>	Height Adjustable Pivot/Slide Arm	+\$125	
<b>A37</b>	Height/Width Adjustable Pivot/Slide Arm	+\$140	
<b>A90</b>	Height/Width Adjustable Breakaway Arm	+\$240	

### BASE OPTIONS

CODE	DESCRIPTION	PRICE	
<b>BA1B</b>	26" Nylon Base • Black	+\$0	
<b>BA2B</b>	26" Aluminum Base • Black	+\$110	
<b>BA2S</b>	26" Aluminum Base • Silver	+\$110	

### STOOL OPTIONS

CODE	DESCRIPTION	PRICE	
<b>CY30</b>	8" Stool • Seat Height: 22"-30" • Use for work surfaces up to 36" • Available with Y1	+\$125	
<b>CY36</b>	10" Stool • Seat Height: 25"-36" • Use for work surfaces up to 42" • Available with Y1	+\$125	

### CASTER OPTIONS

CODE	DESCRIPTION	PRICE	
<b>C4</b>	Heavy Duty Hard Wood Floor and Carpet Casters	+\$0	
<b>C1S</b>	Hard Floor and Carpet Casters	+\$35	
<b>C2S</b>	Decompression Hard Floor and Soft Carpet Casters	+\$35	

### ADDITIONAL OPTIONS

CODE	DESCRIPTION	PRICE	
<b>HR1</b>	Headrest • Pricing applies to any fabric grade	+\$75	
<b>SS</b>	Seat Slider 2.5" • Factory Installed • Not available on stool models	+\$60	



# Theory

THE FACTS SUPPORT THEORY  
AS THE SMART CHOICE

## MESH BACK UPHOLSTERED SEAT

- Task, stool, conference and executive seating
- Mesh or upholstered seat
- Ratchet back with independent height-adjustable lumbar standard
- Warranted to 300 lbs.

Webpage



GSA SIN # 33721

### MODEL / CONTROL

### ARMS MATERIAL

### DIMENSIONS



#### 2170 / Y1

##### Mesh Back - MB & Upholstered Seat - US Simple Synchro Tilt

- Upright tilt lock
- 3:1 back-to-seat tilt ratio
- Center knob tension adjustment
- 360° swivel
- Pneumatic cylinder height adjustment

	T01	A	B/COM	C	D	E	F	G	L3/COL	L4	L5
A00	\$818	\$874	\$904	\$934	\$994	\$1,049	\$1,089	\$1,149	\$1,074	\$1,124	\$1,224
A8B/S	\$923	\$979	\$1,009	\$1,039	\$1,099	\$1,154	\$1,194	\$1,254	\$1,179	\$1,229	\$1,329
A9B/S	\$933	\$989	\$1,019	\$1,049	\$1,109	\$1,164	\$1,204	\$1,264	\$1,189	\$1,239	\$1,339
A10	\$928	\$984	\$1,014	\$1,044	\$1,104	\$1,159	\$1,199	\$1,259	\$1,184	\$1,234	\$1,334
A36	\$943	\$999	\$1,029	\$1,059	\$1,119	\$1,174	\$1,214	\$1,274	\$1,199	\$1,249	\$1,349
A37	\$958	\$1,014	\$1,044	\$1,074	\$1,134	\$1,189	\$1,229	\$1,289	\$1,214	\$1,264	\$1,364

WIDTH:	26.5
DEPTH:	25.0
HEIGHT:	39.5-46.5
SEAT WIDTH:	21.0
SEAT DEPTH:	18.0
SEAT HEIGHT:	16.0-20.5
SEAT HEIGHT W/ SLIDER:	17.5-22.0
BACK WIDTH:	20.0
BACK HEIGHT:	23.0-25.0
COM:	0.9 YD
COL:	11.0 SQ FT
WEIGHT:	42.0 LB

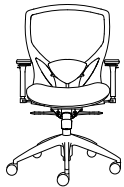

#### 2170 / Y3

##### Mesh Back - MB & Upholstered Seat - US Full Synchro Tilt

- 3-position tilt lock
- 2:1 back-to-seat tilt ratio
- Center knob tension adjustment
- 360° swivel
- Pneumatic cylinder height adjustment

	T01	A	B/COM	C	D	E	F	G	L3/COL	L4	L5
A00	\$878	\$934	\$964	\$994	\$1,054	\$1,109	\$1,149	\$1,209	\$1,134	\$1,184	\$1,284
A8B/S	\$983	\$1,039	\$1,069	\$1,099	\$1,159	\$1,214	\$1,254	\$1,314	\$1,239	\$1,289	\$1,389
A9B/S	\$993	\$1,049	\$1,079	\$1,109	\$1,169	\$1,224	\$1,264	\$1,324	\$1,249	\$1,299	\$1,399
A10	\$988	\$1,044	\$1,074	\$1,104	\$1,164	\$1,219	\$1,259	\$1,319	\$1,244	\$1,294	\$1,394
A36	\$1,003	\$1,059	\$1,089	\$1,119	\$1,179	\$1,234	\$1,274	\$1,334	\$1,259	\$1,309	\$1,409
A37	\$1,018	\$1,074	\$1,104	\$1,134	\$1,194	\$1,249	\$1,289	\$1,349	\$1,274	\$1,324	\$1,424

WIDTH:	26.5
DEPTH:	24.5
HEIGHT:	39.5-46.5
SEAT WIDTH:	21.0
SEAT DEPTH:	18.0
SEAT HEIGHT:	17.0-21.5
SEAT HEIGHT W/ SLIDER:	18.5-23.0
BACK WIDTH:	20.0
BACK HEIGHT:	23.0-25.0
COM:	0.9 YD
COL:	11.0 SQ FT
WEIGHT:	43.5 LB

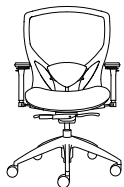

#### 2170 / Y2

##### Mesh Back - MB & Upholstered Seat - US Heavy Duty Synchro Tilt

- 4-position tilt lock
- Side knob tension adjustment
- 2:1 back-to-seat tilt ratio
- 360° swivel
- Pneumatic cylinder height adjustment

	T01	A	B/COM	C	D	E	F	G	L3/COL	L4	L5
A00	\$908	\$964	\$994	\$1,024	\$1,084	\$1,139	\$1,179	\$1,239	\$1,164	\$1,214	\$1,314
A8B/S	\$1,013	\$1,069	\$1,099	\$1,129	\$1,189	\$1,244	\$1,284	\$1,344	\$1,269	\$1,319	\$1,419
A9B/S	\$1,023	\$1,079	\$1,109	\$1,139	\$1,199	\$1,254	\$1,294	\$1,354	\$1,279	\$1,329	\$1,429
A10	\$1,018	\$1,074	\$1,104	\$1,134	\$1,194	\$1,249	\$1,289	\$1,349	\$1,274	\$1,324	\$1,424
A36	\$1,033	\$1,089	\$1,119	\$1,149	\$1,209	\$1,264	\$1,304	\$1,364	\$1,289	\$1,339	\$1,439
A37	\$1,048	\$1,104	\$1,134	\$1,164	\$1,224	\$1,279	\$1,319	\$1,379	\$1,304	\$1,354	\$1,454

WIDTH:	26.5
DEPTH:	25.0
HEIGHT:	38.0-45.0
SEAT WIDTH:	21.0
SEAT DEPTH:	18.5
SEAT HEIGHT:	16.5-21.5
SEAT HEIGHT W/ SLIDER:	18.0-23.0
BACK WIDTH:	20.0
BACK HEIGHT:	21.5-23.5
COM:	0.9 YD
COL:	11.0 SQ FT
WEIGHT:	45.5 LB

# Theory







## MESH BACK UPHOLSTERED SEAT

Webpage

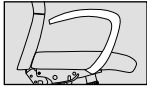
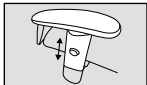

GSA SIN # 33721



### ARM OPTIONS

CODE	DESCRIPTION	PRICE	
<b>A10</b>	Soft Touch C-Shaped Arm	+\$110	
<b>A8B</b>	Height Adjustable Arm • Black	+\$105	
<b>A8S</b>	Height Adjustable Arm • Silver	+\$105	
<b>A9B</b>	Height/Width Adjustable Arm • Black	+\$115	
<b>A9S</b>	Height/Width Adjustable Arm • Silver	+\$115	
<b>A36</b>	Height/Width Adjustable Pivot/Slide Arm	+\$125	
<b>A37</b>	Height/Width Adjustable Pivot/Slide Arm	+\$140	
<b>A90</b>	Height/Width Adjustable Breakaway Arm	+\$240	



### MESH COLORS

CODE	DESCRIPTION	PRICE
<b>M11</b>	Black, M1	+\$0

### STOOL OPTIONS

CODE	DESCRIPTION	PRICE	
<b>CY30B</b>	8" Stool • Seat Height: 22"-30" • Use for work surfaces up to 36" high • Available with Y1	+\$125	
<b>CY36B</b>	10" Stool • Seat Height: 25"-36" • Use for work surfaces up to 42" high • Available with Y1	+\$125	

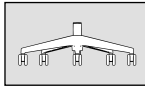
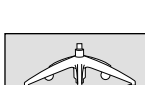
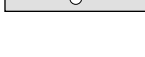
### BASE OPTIONS

CODE	DESCRIPTION	PRICE	
<b>BA11B</b>	27" Mid-Profile Nylon Base • Black	+\$0	
<b>BA12B</b>	27" Mid-Profile Aluminum Base • Black	+\$110	
<b>BA12P</b>	27" Mid-Profile Aluminum Base • Polished	+\$110	
<b>BA12S</b>	27" Mid-Profile Aluminum Base • Silver	+\$110	

### CASTER OPTIONS

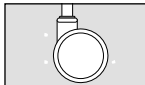
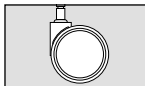
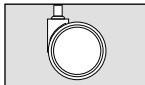
CODE	DESCRIPTION	PRICE	
<b>C6</b>	Large Diameter Carpet Casters	+\$0	
<b>C6S</b>	Large Diameter Hard Floor and Carpet Casters	+\$35	
<b>C7</b>	Chrome-Accented Hard Floor and Carpet Casters	+\$35	

### ADDITIONAL OPTIONS

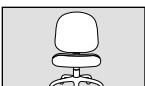
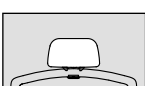
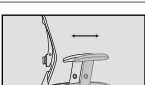
CODE	DESCRIPTION	PRICE	
<b>HD</b>	Heavy Duty Multi-Shift • Upgrade 350 lb. Includes BA12 and C6S. Available with Y2 only.	+\$125	
<b>HR1</b>	Headrest • Pricing applies to any fabric grade	+\$75	
<b>SS</b>	Seat Slider 2.5" • Factory Installed • Not available on stool models	+\$60	



# Theory

THE FACTS SUPPORT THEORY  
AS THE SMART CHOICE

## ALL MESH

- Task, stool, conference and executive seating
- Mesh or upholstered seat
- Ratchet back with independent height-adjustable lumbar standard
- Warranted to 300 lbs.

Webpage

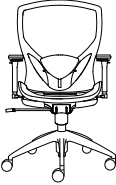
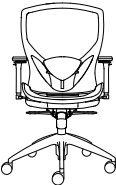
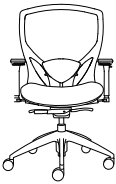

GSA SIN # 33721

MODEL / CONTROL	ARMS	MATERIAL											DIMENSIONS	
 <p><b>2170 / Y1</b> Mesh Back - MB &amp; Mesh Seat - MS Simple Synchro Tilt</p> <ul style="list-style-type: none"> <li>• Upright tilt lock</li> <li>• 3:1 back-to-seat tilt ratio</li> <li>• Center knob tension adjustment</li> <li>• 360° swivel</li> <li>• Pneumatic cylinder height adjustment</li> </ul>		<b>M</b>												WIDTH: 26.5 DEPTH: 26.5 HEIGHT: 38.5-45.5 SEAT WIDTH: 20.0 SEAT DEPTH: 18.0 SEAT HEIGHT: 17.0-20.5 SEAT HEIGHT W/ SEAT SLIDER: 19.0-23.5 BACK WIDTH: 20.5 BACK HEIGHT: 22.5-25.5 COM: N/A COL: N/A WEIGHT: 46.0 LB
	A00	\$874												
	A8B/S	\$979												
	A9B/S	\$989												
	A10	\$984												
	A36	\$999												
A37	\$1,014													
 <p><b>2170 / Y3</b> Mesh Back - MB &amp; Mesh Seat - MS Full Synchro Tilt</p> <ul style="list-style-type: none"> <li>• 3-position tilt lock</li> <li>• 2:1 back-to-seat tilt ratio</li> <li>• Center knob tension adjustment</li> <li>• 360° swivel</li> <li>• Pneumatic cylinder height adjustment</li> </ul>		<b>M</b>											WIDTH: 26.5 DEPTH: 26.5 HEIGHT: 37.5-44.5 SEAT WIDTH: 20.0 SEAT DEPTH: 18.0 SEAT HEIGHT: 16.5-21.0 SEAT HEIGHT W/ SEAT SLIDER: 19.0-23.5 BACK WIDTH: 20.5 BACK HEIGHT: 22.5-25.5 COM: N/A COL: N/A WEIGHT: 46.0 LB	
	A00	\$934												
	A8B/S	\$1,039												
	A9B/S	\$1,049												
	A10	\$1,044												
	A36	\$1,059												
A37	\$1,074													
 <p><b>2170 / Y2</b> Mesh Back - MB &amp; Mesh Seat - MS Heavy Duty Synchro Tilt</p> <ul style="list-style-type: none"> <li>• 4-position tilt lock</li> <li>• Side knob tension adjustment</li> <li>• 2:1 back-to-seat tilt ratio</li> <li>• 360° swivel</li> <li>• Pneumatic cylinder height adjustment</li> </ul>		<b>M</b>											WIDTH: 24.0 DEPTH: 26.5 HEIGHT: 38.5-46.0 SEAT WIDTH: 19.5 SEAT DEPTH: 18.0 SEAT HEIGHT: 17.0-21.5 SEAT HEIGHT W/ SEAT SLIDER: 19.0-23.5 BACK WIDTH: 20.5 BACK HEIGHT: 22.5-25.5 COM: N/A COL: N/A WEIGHT: 46.0 LB	
	A00	\$964												
	A8B/S	\$1,069												
	A9B/S	\$1,079												
	A10	\$1,074												
	A36	\$1,089												
A37	\$1,104													

# Theory







## ALL MESH

Webpage

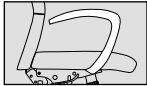
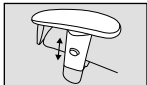

GSA SIN # 33721



### ARM OPTIONS

CODE	DESCRIPTION	PRICE	
<b>A10</b>	Soft Touch C-Shaped Arm	+\$110	
<b>A8B</b>	Height Adjustable Arm • Black	+\$105	
<b>A8S</b>	Height Adjustable Arm • Silver	+\$105	
<b>A9B</b>	Height/Width Adjustable Arm • Black	+\$115	
<b>A9S</b>	Height/Width Adjustable Arm • Silver	+\$115	
<b>A36</b>	Height/Width Adjustable Pivot/Slide Arm	+\$125	
<b>A37</b>	Height/Width Adjustable Pivot/Slide Arm	+\$140	
<b>A90</b>	Height/Width Adjustable Breakaway Arm	+\$240	



### MESH COLORS

CODE	DESCRIPTION	PRICE
<b>M11</b>	Black, M1	+\$0

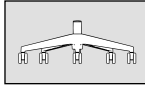
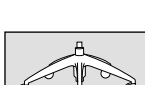
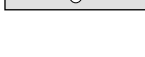

### STOOL OPTIONS

CODE	DESCRIPTION	PRICE	
<b>CY30</b>	8" Stool • (Seat Height: 22"-30") • Use for work surfaces up to 36" high	+\$125	
<b>CY36</b>	10" Stool • (Seat Height: 25"-36") • Use for work surfaces up to 42" high	+\$125	

### BASE OPTIONS

CODE	DESCRIPTION	PRICE	
<b>BA11B</b>	27" Mid-Profile Nylon Base • Black	+\$0	
<b>BA12B</b>	27" Mid-Profile Aluminum Base • Black	+\$110	
<b>BA12P</b>	27" Mid-Profile Aluminum Base • Polished	+\$110	
<b>BA12S</b>	27" Mid-Profile Aluminum Base • Silver	+\$110	

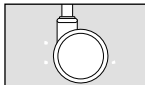
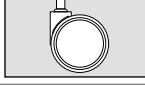
### CASTER OPTIONS

CODE	DESCRIPTION	PRICE	
<b>C6</b>	Large Diameter Carpet Casters	+\$0	
<b>C6S</b>	Large Diameter Hard Floor and Carpet Casters	+\$35	
<b>C7</b>	Chrome-Accented Hard Floor and Carpet Casters	+\$35	

### ADDITIONAL OPTIONS

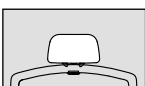
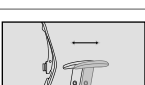
CODE	DESCRIPTION	PRICE	
<b>HR1</b>	Headrest • Pricing applies to any fabric grade	+\$75	
<b>SS</b>	Seat Slider 2.5" • Factory Installed • Not available on stool models	+\$60	



# Tori

UNPARALLELED PERFORMANCE  
WITH IMPACT

## MID-BACK

- Task, stool, conference and executive seating
- Wraparound back design
- Mid-back and high-back models
- Mesh back or upholstered back models
- Multiple frame and mesh colors
- Seat slider and lumbar available
- Warranted to 300 lbs

Webpage



GSA SIN # 33721 PENDING

### MODEL / CONTROL

### ARMS MATERIAL

### DIMENSIONS



#### 3560 / Y1

##### Mesh Back - MB Simple-Synchro Tilt

- Upright tilt lock
- 3:1 back-to seat tilt ratio
- Center knob tension adjustment
- 360° swivel
- Pneumatic cylinder height adjustment
- Seat slider optional

	A	B/COM	C	D	E	F	G			
A00	\$785	\$815	\$845	\$905	\$960	\$1000	\$1060			
A43	\$805	\$835	\$865	\$925	\$980	\$1020	\$1080			
A57	\$815	\$845	\$875	\$935	\$990	\$1030	\$1090			
A58	\$850	\$880	\$910	\$970	\$1025	\$1065	\$1125			
A59	\$885	\$915	\$945	\$1005	\$1060	\$1100	\$1160			

WIDTH: 26.5  
DEPTH: 24.5  
HEIGHT: 37.0-42.0  
SEAT WIDTH: 20.5  
SEAT DEPTH: 18.5  
SEAT HEIGHT: 17.0-22.0  
BACK WIDTH: 20.0  
BACK HEIGHT: 20.0  
COM: 0.9 YD  
COL: 4.02 SQ FT  
WEIGHT: 37.0 LB



#### 3560 / Y6

##### Mesh Back - MB Deluxe Synchro Tilt

- Integrated seat slider
- 4-position tilt lock
- Side knob tension adjustment
- 2:1 back-to seat tilt ratio
- 360° swivel
- Pneumatic cylinder height adjustment

	A	B/COM	C	D	E	F	G			
A00	\$890	\$920	\$950	\$1010	\$1065	\$1105	\$1165			
A43	\$910	\$940	\$970	\$1030	\$1085	\$1125	\$1185			
A57	\$920	\$950	\$980	\$1040	\$1095	\$1135	\$1195			
A58	\$955	\$985	\$1015	\$1075	\$1130	\$1170	\$1230			
A59	\$990	\$1020	\$1050	\$1110	\$1165	\$1205	\$1265			

WIDTH: 26.5  
DEPTH: 24.5  
HEIGHT: 37.0-42.0  
SEAT WIDTH: 20.5  
SEAT DEPTH: 18.5  
SEAT HEIGHT: 16.0-21.00  
BACK WIDTH: 20.0  
BACK HEIGHT: 20.0  
COM: 0.9 YD  
COL: 4.02 SQ FT  
WEIGHT: 37.0 LB



#### 3560 / Y1

##### Upholstered Back - UB Simple-Synchro Tilt

- Upright tilt lock
- 3:1 back-to seat tilt ratio
- Center knob tension adjustment
- 360° swivel
- Pneumatic cylinder height adjustment
- Seat slider optional

	A	B/COM	C	D	E	F	G			
A00	\$850	\$920	\$978	\$1040	\$1145	\$1250	\$1350			
A43	\$870	\$940	\$998	\$1060	\$1165	\$1270	\$1370			
A57	\$880	\$950	\$1008	\$1070	\$1175	\$1280	\$1380			
A58	\$915	\$985	\$1043	\$1105	\$1210	\$1315	\$1415			
A59	\$950	\$1020	\$1078	\$1140	\$1245	\$1350	\$1450			

WIDTH: 26.5  
DEPTH: 24.5  
HEIGHT: 37.0-42.0  
SEAT WIDTH: 20.5  
SEAT DEPTH: 18.5  
SEAT HEIGHT: 17.0-22.0  
BACK WIDTH: 20.0  
BACK HEIGHT: 20.0  
COM: 1.85 YD  
COL: 7.42 SQ FT  
WEIGHT: 37.0 LB



#### 3560 / Y6

##### Upholstered Back - UB Deluxe Synchro Tilt

- Integrated seat slider
- 4-position tilt lock
- Side knob tension adjustment
- 2:1 back-to seat tilt ratio
- 360° swivel
- Pneumatic cylinder height adjustment

	A	B/COM	C	D	E	F	G			
A00	\$955	\$1025	\$1083	\$1145	\$1250	\$1355	\$1455			
A43	\$975	\$1045	\$1103	\$1165	\$1270	\$1375	\$1475			
A57	\$985	\$1055	\$1113	\$1175	\$1280	\$1385	\$1485			
A58	\$1020	\$1090	\$1148	\$1210	\$1315	\$1420	\$1520			
A59	\$1055	\$1125	\$1183	\$1245	\$1350	\$1455	\$1555			

WIDTH: 26.5  
DEPTH: 24.5  
HEIGHT: 37.0-42.0  
SEAT WIDTH: 20.5  
SEAT DEPTH: 18.5  
SEAT HEIGHT: 16.0-21.00  
BACK WIDTH: 20.0  
BACK HEIGHT: 20.0  
COM: 1.85 YD  
COL: 7.42 SQ FT  
WEIGHT: 37.0 LB

# Tori

## MID-BACK



GSA SIN # 33721 PENDING

### ARM OPTIONS

CODE	DESCRIPTION	PRICE	
A43B	Fixed Arm • Black	+\$75	
A43D	Fixed Arm • Dove Gray	+\$75	
A57B	Height Adjustable • Black	+\$90	
A57D	Height Adjustable • Dove Gray	+\$90	
A57W	Height Adjustable • White	+\$90	
A58B	Height/Width Adjustable • Black	+\$125	
A58D	Height/Width Adjustable • Dove Gray	+\$125	
A58W	Height/Width Adjustable • White	+\$125	
A59B	Height/Width Adjustable Pivot/Slide pad • Black	+\$160	
A59D	Height/Width Adjustable Pivot/Slide pad • Dove Gray	+\$160	
A59W	Height/Width Adjustable Pivot/Slide pad • White	+\$160	

### PLASTIC COLORS

CODE	DESCRIPTION	PRICE	CODE	DESCRIPTION	PRICE
PBK	Black	+\$0	PWH	White	+\$35
PDG	Dove Gray	+\$35			

### MESH COLORS

CODE	DESCRIPTION	PRICE	CODE	DESCRIPTION	PRICE
M61	Black, M6	+\$0	M64	Blue, M6	+\$0
M62	Gray, M6	+\$0	M65	Green, M6	+\$0
M63	White, M6	+\$0			

### CASTER OPTIONS

CODE	DESCRIPTION	PRICE	
C6	Large Diameter Carpet Casters	+\$0	
C6S	Large Diameter Hard Floor and Carpet Casters	+\$35	
C6D	Large Diameter Carpet Casters • Dove Gray	+\$0	
C6W	Large Diameter Carpet Casters • White	+\$0	
C7	Chrome-Accented Hard Floor and Carpet Casters	+\$35	

### CYLINDER OPTIONS

CODE	DESCRIPTION	PRICE	
CY17	Low Cylinder-CY17 • Seat Height 15"-18"	+\$0	
CY20	Standard Cylinder-CY20 • Seat Height 16"-21"	+\$0	
CY24	High Cylinder-CY24 • Seat Height 19"-24" • FR20-Foot Ring can be added - \$90 list	+\$0	

### STOOL OPTIONS

CODE	DESCRIPTION	PRICE	
CY30	8" Stool • (Seat Height: 22"-30") • Use for work surfaces up to 36" • Available with Y1	+\$125	
CY36	10" Stool • (Seat Height: 25"-36") • Use for work surfaces up to 42" • Available with Y1	+\$125	

### BASE OPTIONS

CODE	DESCRIPTION	PRICE	
BA26B	27" Low Profile Nylon Base • Black	+\$0	
BA26D	27" Low Profile Nylon Base • Dove Gray	+\$0	
BA26W	27" Low Profile Nylon Base • White	+\$0	
BA36P	27" Low Profile Aluminum Base • Polished	+\$110	
BA36S	27" Low Profile Aluminum Base • Silver	+\$110	
JB1	Jury Base	+\$300	

### ADDITIONAL OPTIONS

CODE	DESCRIPTION	PRICE	
HD	Heavy Duty Multi-Shift • Upgrade 350 lb. Includes BA36P/S Low Profile Aluminum Base (Y6 control only) with C7 casters	+\$125	
LB	Height Adjustable Lumbar	+\$30	
SS	Seat Slider 2.5" • Side Paddle Activated • Optional seat slider applies to Y1 only	+\$60	
TT	Two Tone Contrasting Upholstery (seat and back) • If the two upholstery selections are of different grades, the chair will price at the higher of the two grades.	+\$50	



# Tori

UNPARALLELED PERFORMANCE  
WITH IMPACT

## HIGH-BACK

- Task, stool, conference and executive seating
- Wraparound back design
- Mid-back and high-back models
- Mesh back or upholstered back models
- Multiple frame and mesh colors
- Seat slider and lumbar available
- Warranted to 300 lbs

Webpage



GSA SIN # 33721 PENDING

### MODEL / CONTROL

### ARMS MATERIAL

### DIMENSIONS

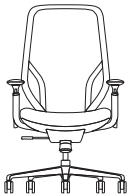

#### 3580 / Y1

##### Mesh Back - MB Simple-Synchro Tilt

- Upright tilt lock
- 3:1 back-to seat tilt ratio
- Center knob tension adjustment
- 360° swivel
- Pneumatic cylinder height adjustment
- Seat slider optional

	A	B/COM	C	D	E	F	G			
A00	\$790	\$820	\$850	\$910	\$965	\$1005	\$1065			
A43	\$810	\$840	\$870	\$930	\$985	\$1025	\$1085			
A57	\$820	\$850	\$880	\$940	\$995	\$1035	\$1095			
A58	\$855	\$885	\$915	\$975	\$1030	\$1070	\$1130			
A59	\$890	\$920	\$950	\$1010	\$1065	\$1105	\$1165			

WIDTH: 26.5  
DEPTH: 24.5  
HEIGHT: 40.0-45.0  
SEAT WIDTH: 20.5  
SEAT DEPTH: 18.5  
SEAT HEIGHT: 17.0-22.0  
BACK WIDTH: 20.0  
BACK HEIGHT: 24.0  
COM: 0.9 YD  
COL: 4.02 SQ FT  
WEIGHT: 38.5 LB

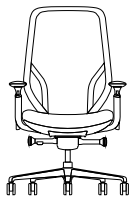

#### 3580 / Y6

##### Mesh Back - MB Deluxe Synchro Tilt

- Integrated seat slider
- 4-position tilt lock
- Side knob tension adjustment
- 2:1 back-to seat tilt ratio
- 360° swivel
- Pneumatic cylinder height adjustment

	A	B/COM	C	D	E	F	G			
A00	\$895	\$925	\$955	\$1015	\$1070	\$1110	\$1170			
A43	\$915	\$945	\$975	\$1035	\$1090	\$1130	\$1190			
A57	\$925	\$955	\$985	\$1045	\$1100	\$1140	\$1200			
A58	\$960	\$990	\$1020	\$1080	\$1135	\$1175	\$1235			
A59	\$995	\$1025	\$1055	\$1115	\$1170	\$1210	\$1270			

WIDTH: 26.5  
DEPTH: 24.5  
HEIGHT: 40.0-45.0  
SEAT WIDTH: 20.5  
SEAT DEPTH: 18.5  
SEAT HEIGHT: 16.0-21.0  
BACK WIDTH: 20.0  
BACK HEIGHT: 24.0  
COM: 0.9 YD  
COL: 4.02 SQ FT  
WEIGHT: 38.5 LB

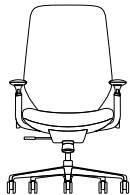

#### 3580 / Y1

##### Upholstered Back - UB Simple-Synchro Tilt

- Upright tilt lock
- 3:1 back-to seat tilt ratio
- Center knob tension adjustment
- 360° swivel
- Pneumatic cylinder height adjustment
- Seat slider optional

	A	B/COM	C	D	E	F	G			
A00	\$855	\$925	\$983	\$1045	\$1150	\$1255	\$1355			
A43	\$875	\$945	\$1003	\$1065	\$1170	\$1275	\$1375			
A57	\$885	\$955	\$1013	\$1075	\$1180	\$1285	\$1385			
A58	\$920	\$990	\$1048	\$1110	\$1215	\$1320	\$1420			
A59	\$955	\$1025	\$1083	\$1145	\$1250	\$1355	\$1455			

WIDTH: 26.5  
DEPTH: 24.5  
HEIGHT: 40.0-45.0  
SEAT WIDTH: 20.5  
SEAT DEPTH: 18.5  
SEAT HEIGHT: 17.0-22.0  
BACK WIDTH: 20.0  
BACK HEIGHT: 24.0  
COM: 2.0 YD  
COL: 8.88 SQ FT  
WEIGHT: 38.5 LB

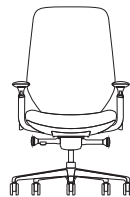

#### 3580 / Y6

##### Upholstered Back - UB Deluxe Synchro Tilt

- Integrated seat slider
- 4-position tilt lock
- Side knob tension adjustment
- 2:1 back-to seat tilt ratio
- 360° swivel
- Pneumatic cylinder height adjustment

	A	B/COM	C	D	E	F	G			
A00	\$960	\$1030	\$1088	\$1150	\$1255	\$1360	\$1460			
A43	\$980	\$1050	\$1108	\$1170	\$1275	\$1380	\$1480			
A57	\$990	\$1060	\$1118	\$1180	\$1285	\$1390	\$1490			
A58	\$1025	\$1095	\$1153	\$1215	\$1320	\$1425	\$1525			
A59	\$1060	\$1130	\$1188	\$1250	\$1355	\$1460	\$1560			

WIDTH: 26.5  
DEPTH: 24.5  
HEIGHT: 40.0-45.0  
SEAT WIDTH: 20.5  
SEAT DEPTH: 18.5  
SEAT HEIGHT: 16.0-21.0  
BACK WIDTH: 20.0  
BACK HEIGHT: 24.0  
COM: 2.0 YD  
COL: 8.88 SQ FT  
WEIGHT: 38.5 LB

# Tori

## HIGH-BACK



Webpage

GSA SIN # 33721 PENDING

### ARM OPTIONS

CODE	DESCRIPTION	PRICE	
<b>A43B</b>	Fixed Arm • Black	+\$75	
<b>A43D</b>	Fixed Arm • Dove Gray	+\$75	
<b>A57B</b>	Height Adjustable • Black	+\$90	
<b>A57D</b>	Height Adjustable • Dove Gray	+\$90	
<b>A57W</b>	Height Adjustable • White	+\$90	
<b>A58B</b>	Height/Width Adjustable • Black	+\$125	
<b>A58D</b>	Height/Width Adjustable • Dove Gray	+\$125	
<b>A58W</b>	Height/Width Adjustable • White	+\$125	
<b>A59B</b>	Height/Width Adjustable Pivot/Slide pad • Black	+\$160	
<b>A59D</b>	Height/Width Adjustable Pivot/Slide pad • Dove Gray	+\$160	
<b>A59W</b>	Height/Width Adjustable Pivot/Slide pad • White	+\$160	

### PLASTIC COLORS

CODE	DESCRIPTION	PRICE	CODE	DESCRIPTION	PRICE
<b>PBK</b>	Black	+\$0	<b>PWH</b>	White	+\$35
<b>PDG</b>	Dove Gray	+\$35			

### MESH COLORS

CODE	DESCRIPTION	PRICE	CODE	DESCRIPTION	PRICE
<b>M61</b>	Black, M6	+\$0	<b>M64</b>	Blue, M6	+\$0
<b>M62</b>	Gray, M6	+\$0	<b>M65</b>	Green, M6	+\$0
<b>M63</b>	White, M6	+\$0			

### CASTER OPTIONS

CODE	DESCRIPTION	PRICE	
<b>C6</b>	Large Diameter Carpet Casters	+\$0	
<b>C6S</b>	Large Diameter Hard Floor and Carpet Casters	+\$35	
<b>C6D</b>	Large Diameter Carpet Casters • Dove Gray	+\$0	
<b>C6W</b>	Large Diameter Carpet Casters • White	+\$0	
<b>C7</b>	Chrome-Accented Hard Floor and Carpet Casters	+\$35	

### CYLINDER OPTIONS

CODE	DESCRIPTION	PRICE	
<b>CY17</b>	Low Cylinder-CY17 • Seat Height 15"-18"	+\$0	
<b>CY20</b>	Standard Cylinder-CY20 • Seat Height 16"-21"	+\$0	
<b>CY24</b>	High Cylinder-CY24 • Seat Height 19"-24" • FR20-Foot Ring can be added - \$90 list	+\$0	

### BASE OPTIONS

CODE	DESCRIPTION	PRICE	
<b>BA26B</b>	27" Low Profile Nylon Base • Black	+\$0	
<b>BA26D</b>	27" Low Profile Nylon Base • Dove Gray	+\$0	
<b>BA26W</b>	27" Low Profile Nylon Base • White	+\$0	
<b>BA36P</b>	27" Low Profile Aluminum Base • Polished	+\$110	
<b>BA36S</b>	27" Low Profile Aluminum Base • Silver	+\$110	
<b>JB1</b>	Jury Base	+\$300	

### ADDITIONAL OPTIONS

CODE	DESCRIPTION	PRICE	
<b>HD</b>	Heavy Duty Multi-Shift • Upgrade 350 lb. Includes BA36P/S Low Profile Aluminum Base (Y6 control only) with C7 casters	+\$125	
<b>LB</b>	Height Adjustable Lumbar	+\$30	
<b>SS</b>	Seat Slider 2.5" • Side Paddle Activated • Optional seat slider applies to Y1 only	+\$60	
<b>TT</b>	Two Tone Contrasting Upholstery (seat and back) • If the two upholstery selections are of different grades, the chair will price at the higher of the two grades.	+\$50	



# Vault

GOES BEYOND THE EXPECTED

## MESH BACK UPHOLSTERED SEAT

- Task, stool, conference and executive seating
- Ratchet back lumbar height adjustment
- Seat slider standard
- Warranted to 300 lbs.

Webpage



GSA SIN # 33721

### MODEL / CONTROL

### ARMS MATERIAL

### DIMENSIONS



#### 1460 / Y1

##### Mesh Back - MB & Upholstered Seat - US Simple Synchro Tilt

- Upright tilt lock
- 3:1 back-to-seat tilt ratio
- Center knob tension adjustment
- 360° swivel
- Pneumatic cylinder height adjustment

	T01	A	B/COM	C	D	E	F	G	L3/COL	L4	L5
A00	\$677	\$702	\$732	\$762	\$822	\$877	\$917	\$977	\$902	\$902	\$1,052
A6	\$837	\$862	\$892	\$922	\$982	\$1,037	\$1,077	\$1,137	\$1,062	\$1,062	\$1,212
A7	\$852	\$877	\$907	\$937	\$997	\$1,052	\$1,092	\$1,152	\$1,077	\$1,077	\$1,227
A8B/S	\$782	\$807	\$837	\$867	\$927	\$982	\$1,022	\$1,082	\$1,007	\$1,007	\$1,157
A9B/S	\$792	\$817	\$847	\$877	\$937	\$992	\$1,032	\$1,092	\$1,017	\$1,017	\$1,167
A10	\$787	\$812	\$842	\$872	\$932	\$987	\$1,027	\$1,087	\$1,012	\$1,012	\$1,162
A36	\$802	\$827	\$857	\$887	\$947	\$1,002	\$1,042	\$1,102	\$1,027	\$1,027	\$1,177
A37	\$817	\$842	\$872	\$902	\$962	\$1,017	\$1,057	\$1,117	\$1,042	\$1,042	\$1,192

WIDTH: 24.5-26  
DEPTH: 25.0  
HEIGHT: 39.0-46  
SEAT WIDTH: 20.0  
SEAT DEPTH: 16.0-18.5  
SEAT HEIGHT: 17.5-22.5  
BACK WIDTH: 18.5  
BACK HEIGHT: 23.0-25.5  
COM: 0.9 YD  
COL: 11.0 SQ FT  
WEIGHT: 40.5 LB

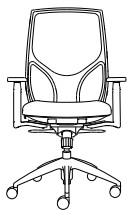

#### 1460 / Y3

##### Mesh Back - MB & Upholstered Seat - US Full Synchro Tilt

- 3-position tilt lock
- 2:1 back-to-seat tilt ratio
- Center knob tension adjustment
- 360° swivel
- Pneumatic cylinder height adjustment

	T01	A	B/COM	C	D	E	F	G	L3/COL	L4	L5
A00	\$737	\$762	\$792	\$822	\$882	\$937	\$977	\$1,037	\$962	\$962	\$1,112
A6	\$897	\$922	\$952	\$982	\$1,042	\$1,097	\$1,137	\$1,197	\$1,122	\$1,122	\$1,272
A7	\$912	\$937	\$967	\$997	\$1,057	\$1,112	\$1,152	\$1,212	\$1,137	\$1,137	\$1,287
A8B/S	\$842	\$867	\$897	\$927	\$987	\$1,042	\$1,082	\$1,142	\$1,067	\$1,067	\$1,217
A9B/S	\$852	\$877	\$907	\$937	\$997	\$1,052	\$1,092	\$1,152	\$1,077	\$1,077	\$1,227
A10	\$847	\$872	\$902	\$932	\$992	\$1,047	\$1,087	\$1,147	\$1,072	\$1,072	\$1,222
A36	\$862	\$887	\$917	\$947	\$1,007	\$1,062	\$1,102	\$1,162	\$1,087	\$1,087	\$1,237
A37	\$877	\$902	\$932	\$962	\$1,022	\$1,077	\$1,117	\$1,177	\$1,102	\$1,102	\$1,252

WIDTH: 24.5-26  
DEPTH: 25.0  
HEIGHT: 39.0-46  
SEAT WIDTH: 20.0  
SEAT DEPTH: 16.0-18.5  
SEAT HEIGHT: 17.5-22.5  
BACK WIDTH: 18.5  
BACK HEIGHT: 23.0-25.5  
COM: 0.9 YD  
COL: 11.0 SQ FT  
WEIGHT: 41 LB



#### 1460 / K2

##### Mesh Back - MB & Upholstered Seat - US Enhanced Knee Tilt

- 4-position tilt lock
- Side knob tension adjustment
- 2:1 back-to-seat tilt ratio
- 360° swivel
- Pneumatic cylinder height adjustment

	T01	A	B/COM	C	D	E	F	G	L3/COL	L4	L5
A00	\$767	\$792	\$822	\$852	\$912	\$967	\$1,007	\$1,067	\$992	\$992	\$1,142
A6	\$927	\$952	\$982	\$1,012	\$1,072	\$1,127	\$1,167	\$1,227	\$1,152	\$1,152	\$1,302
A7	\$942	\$967	\$997	\$1,027	\$1,087	\$1,142	\$1,182	\$1,242	\$1,167	\$1,167	\$1,317
A8B/S	\$872	\$897	\$927	\$957	\$1,017	\$1,072	\$1,112	\$1,172	\$1,097	\$1,097	\$1,247
A9B/S	\$882	\$907	\$937	\$967	\$1,027	\$1,082	\$1,122	\$1,182	\$1,107	\$1,107	\$1,257
A10	\$877	\$902	\$932	\$962	\$1,022	\$1,077	\$1,117	\$1,177	\$1,102	\$1,102	\$1,252
A36	\$892	\$917	\$947	\$977	\$1,037	\$1,092	\$1,132	\$1,192	\$1,117	\$1,117	\$1,267
A37	\$907	\$932	\$962	\$992	\$1,052	\$1,107	\$1,147	\$1,207	\$1,132	\$1,132	\$1,282

WIDTH: 24.5-26  
DEPTH: 25.0  
HEIGHT: 39.0-46  
SEAT WIDTH: 20.0  
SEAT DEPTH: 16.0-18.5  
SEAT HEIGHT: 17.5-22.5  
BACK WIDTH: 18.5  
BACK HEIGHT: 23.0-25.5  
COM: 0.9 YD  
COL: 11.0 SQ FT  
WEIGHT: 41 LB



### ARM OPTIONS

CODE	DESCRIPTION	PRICE	
<b>A6</b>	Height Adjustable Pivot Slide Arm	+\$160	
<b>A7</b>	Height/Width Adjustable Pivot Slide Arm	+\$175	
<b>A8B</b>	Height Adjustable Arm • Black	+\$105	
<b>A8S</b>	Height Adjustable Arm • Silver	+\$105	
<b>A9B</b>	Height/Width Adjustable Arm • Black	+\$115	
<b>A9S</b>	Height/Width Adjustable Arm • Silver	+\$115	
<b>A10</b>	Soft Touch C-Shaped Arm	+\$110	
<b>A36</b>	Height Adjustable Pivot/Slide Arm	+\$125	
<b>A37</b>	Height/Width Adjustable Pivot/Slide Arm	+\$140	
<b>A90</b>	Height/Width Adjustable Breakaway Arm	+\$240	

### MESH COLORS

CODE	DESCRIPTION	PRICE	CODE	DESCRIPTION	PRICE
<b>M21</b>	Black, M2	+\$0	<b>M41</b>	Cloud, M4	+\$0
<b>M22</b>	Gray, M2	+\$0	<b>M42</b>	Lemon, M4	+\$0
<b>M23</b>	White, M2	+\$0	<b>M43</b>	Apple, M4	+\$0
<b>M24</b>	Green, M2	+\$0	<b>M46</b>	Crimson Red, M4	+\$0
<b>M25</b>	Red, M2	+\$0	<b>M48</b>	Onyx, M4	+\$0
<b>M26</b>	Blue, M2	+\$0	<b>M49</b>	Dove, M4	+\$0
<b>M27</b>	Orange, M2	+\$0	<b>M50</b>	Azure, M4	+\$0
<b>M28</b>	Aqua, M2	+\$0	<b>M51</b>	Federal Blue, M4	+\$0
<b>M40</b>	Latte, M4	+\$0	<b>M52</b>	White Whisper, M4	+\$0

### STOOL OPTIONS

CODE	DESCRIPTION	PRICE	
<b>CY30</b>	8" Stool • Seat Height: 22"-30" • Use for work surfaces up to 36" high • Available with Y1	+\$125	
<b>CY36</b>	10" Stool • Seat Height: 25"-36" • Use for work surfaces up to 42" high • Available with Y1	+\$125	

### BASE OPTIONS

CODE	DESCRIPTION	PRICE	
<b>BA11B</b>	27" Mid-Profile Nylon Base • Black	+\$0	
<b>BA12B</b>	27" Mid-Profile Aluminum Base • Black	+\$110	
<b>BA12P</b>	27" Mid-Profile Aluminum Base • Polished	+\$110	
<b>BA12S</b>	27" Mid-Profile Aluminum Base • Silver	+\$110	

### CASTER OPTIONS

CODE	DESCRIPTION	PRICE	
<b>C6</b>	Large Diameter Carpet Casters	+\$0	
<b>C6S</b>	Large Diameter Hard Floor and Carpet Casters	+\$35	
<b>C7</b>	Chrome-Accented Hard Floor and Carpet Casters	+\$35	

### ADDITIONAL OPTIONS

CODE	DESCRIPTION	PRICE	
<b>EF1</b>	1" Extra Foam on Seat. • If EF1 is selected, cannot use MF1 in addition.	+\$30	
<b>MF1</b>	1" Visco Elastic Memory Foam on Seat. • If MF1 is selected, cannot use EF1 in addition.	+\$50	
<b>HR2</b>	Headrest • Available with M2 or M4 mesh	+\$75	



# Vox

CONTEMPORARY STACKING

## 4 LEG

- Stacking side, guest, task and stool
- Flexback movement
- All plastic, upholstered seat or upholstered back and seat
- Pull handle for easy mobility
- Warranted to 300 lbs.

Webpage



GSA SIN # 33721 PENDING

### MODEL / CHAIR TYPE

### ARMS MATERIAL

### DIMENSIONS



#### 1090 / FRM Plastic Back - PB & Plastic Seat - PS Stacking

- Stacks 4 high on the floor
- Stacks 8 high on the optional stacking dolly
- Arms and glides coordinate with the frame color
- Non-marring glides standard

	P											
A00	\$304											
A53	\$359											

	ARMLESS	ARMS
WIDTH:	21.5	22.5
DEPTH:	21.0	21.0
HEIGHT:	34.0	34.0
SEAT WIDTH:	18.5	18.5
SEAT DEPTH:	16.0	16.0
BACK WIDTH:	18.0	18.0
BACK HEIGHT:	17.5	17.5
COM:	N/A	N/A
COL:	N/A	N/A
WEIGHT:	16.0 LB	18.0 LB



#### 1090 / FRM Plastic Back - PB & Upholstered Seat - US Stacking

- Stacks 4 high on the floor
- Stacks 8 high on the optional stacking dolly
- Arms and glides coordinate with the frame color
- Non-marring glides standard

	A	B/COM	C	D	E	F	G	L3/COL	L4	L5
A00	\$369	\$391	\$414	\$444	\$479	\$514	\$544	\$519	\$569	\$639
A53	\$424	\$446	\$469	\$499	\$534	\$569	\$599	\$574	\$624	\$694

	ARMLESS	ARMS
WIDTH:	21.5	22.5
DEPTH:	21.0	21.0
HEIGHT:	34.0	34.0
SEAT WIDTH:	18.5	18.5
SEAT DEPTH:	16.0	16.0
BACK WIDTH:	18.0	18.0
BACK HEIGHT:	17.5	17.5
COM:	0.5 YD	0.5 YD
COL:	3.91 SQ FT	3.91 SQ FT
WEIGHT:	16.0 LB	18.0 LB



#### 1090 / FRM Upholstered Back - UB & Upholstered Seat - US Stacking

- Stacks 4 high on the floor
- Stacks 8 high on the optional stacking dolly
- Arms and glides coordinate with the frame color
- Non-marring glides standard

	A	B/COM	C	D	E	F	G	L3/COL	L4	L5
A00	\$434	\$464	\$484	\$519	\$549	\$584	\$619	\$594	\$644	\$714
A53	\$489	\$519	\$539	\$574	\$604	\$639	\$674	\$649	\$699	\$769

	ARMLESS	ARMS
WIDTH:	21.5	22.5
DEPTH:	21.0	21.0
HEIGHT:	34.0	34.0
SEAT WIDTH:	18.5	18.5
SEAT DEPTH:	16.0	16.0
BACK WIDTH:	18.0	18.0
BACK HEIGHT:	17.5	17.5
COM:	1.0 YD	1.0 YD
COL:	7.82 SQ FT	7.82 SQ FT
WEIGHT:	16.0 LB	18.0 LB



### ARM OPTIONS

CODE	DESCRIPTION	PRICE
<b>A53B</b>	Nylon Fixed Arm for 4 leg models • Black	+\$55
<b>A53G</b>	Nylon Fixed Arm for 4 leg models • Cloud Gray	+\$55



### FRAME COLORS

CODE	DESCRIPTION	PRICE
<b>4LGB</b>	Black	+\$0
<b>4LGS</b>	Silver	+\$0

### PLASTIC COLORS

CODE	DESCRIPTION	PRICE
<b>P01</b>	Black Swan	+\$0
<b>P05</b>	White Whisper	+\$0
<b>P11</b>	Federal Blue	+\$0
<b>P12</b>	Crimson Red	+\$0
<b>P13</b>	Lemon Yellow	+\$0
<b>P14</b>	Dove Gray	+\$0
<b>P15</b>	Cloud Gray	+\$0
<b>P16</b>	Lagoon Blue	+\$0
<b>P17</b>	Apple Green	+\$0
<b>P18</b>	Tangerine Orange	+\$0
<b>P19</b>	Latte	+\$0
<b>P20</b>	Azure Blue	+\$0

### STOOL OPTIONS

CODE	DESCRIPTION	PRICE
<b>ST24B</b>	24" Counter Stool • Use for work surfaces up to 36" high • Black	+\$130
<b>ST24S</b>	24" Counter Stool • Use for work surfaces up to 36" high • Silver	+\$130
<b>ST30B</b>	30" Bar Stool • Use for work surfaces up to 42" high • Black	+\$150
<b>ST30S</b>	30" Bar Stool • Use for work surfaces up to 42" high • Silver	+\$150



### CASTER OPTIONS

CODE	DESCRIPTION	PRICE
<b>C12S</b>	Hard Floor and Carpet Casters	+\$45

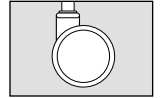

### ADDITIONAL OPTIONS

CODE	DESCRIPTION	PRICE
<b>G21B</b>	Tapered Plastic Glide • Black	+\$0
<b>G21G</b>	Tapered Plastic Glide • Gray	+\$0
<b>G21BN</b>	Swivel Nylon Glide • Black	+\$20
<b>G21GN</b>	Swivel Nylon Glide • Gray	+\$20
<b>G21BS</b>	Swivel Steel Glide • Black	+\$20
<b>G21GS</b>	Swivel Steel Glide • Gray	+\$20
<b>G21BF</b>	Swivel Felt Glide • Black	+\$20
<b>G21GF</b>	Swivel Felt Glide • Gray	+\$20

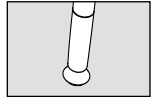
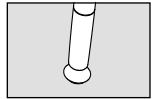
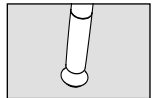
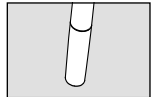

### ACCESSORIES

CODE	DESCRIPTION	PRICE
<b>GC7</b>	Ganging Clip • 2 per set, for 4-leg models • Arm-to-Arm and Armless-to-Armless	+\$30
<b>DL5</b>	Stacking Dolly • Stacks up to 8 High - 4-Leg Models • Stacks up to 20 High - Sled Models	+\$399

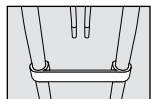

Due to the nature of upholstery, stacking may cause impressions on the seat. 9to5 Seating does not warrant effects of stacking on upholstery.



# Vox

CONTEMPORARY STACKING

## SLED

- Stacking side, guest, task and stool
- Flexback movement
- All plastic, upholstered seat or upholstered back and seat
- Pull handle for easy mobility
- Warranted to 300 lbs.

Webpage



GSA SIN # 33721 PENDING

**MODEL / CHAIR TYPE**

**ARMS MATERIAL**

**DIMENSIONS**



**1090 / FRM**  
**Plastic Back - PB &**  
**Plastic Seat - PS**  
**Sled**

- Stacks 7 high on the floor
- Stacks 20 high on the optional stacking dolly
- Arms and glides coordinate with the frame color
- Optional glides available

	P											
A00	\$282											
A54	\$337											

	ARMLESS	ARMS
WIDTH:	21.5	22.5
DEPTH:	21.0	36.0
HEIGHT:	36.0	36.0
SEAT WIDTH:	18.5	18.5
SEAT DEPTH:	16.0	16.0
SEAT HEIGHT:	18.5	18.5
BACK WIDTH:	18.0	18.0
BACK HEIGHT:	17.5	17.5
COM:	N/A	N/A
COL:	N/A	N/A
WEIGHT:	16.0 LB	18.0 LB



**1090 / FRM**  
**Plastic Back - PB &**  
**Upholstered Seat - US**  
**Sled**

- Stacks 7 high on the floor
- Stacks 20 high on the optional stacking dolly
- Arms and glides coordinate with the frame color
- Optional glides available

	A	B/COM	C	D	E	F	G	L3/COL	L4	L5
A00	\$347	\$369	\$392	\$422	\$457	\$492	\$522	\$497	\$547	\$617
A54	\$402	\$424	\$447	\$477	\$512	\$547	\$577	\$552	\$602	\$672

	ARMLESS	ARMS
WIDTH:	21.5	22.5
DEPTH:	21.0	21.0
HEIGHT:	36.0	36.0
SEAT WIDTH:	18.5	18.5
SEAT DEPTH:	16.0	16.0
SEAT HEIGHT:	18.5	18.5
BACK WIDTH:	18.0	18.0
BACK HEIGHT:	17.5	17.5
COM:	0.5 YD	0.5 YD
COL:	3.91 SQ FT	3.91 SQ FT
WEIGHT:	16.0 LB	18.0 LB



**1090 / FRM**  
**Upholstered Back - UB**  
**& Upholstered Seat - US**  
**Sled**

- Stacks 7 high on the floor
- Stacks 20 high on the optional stacking dolly
- Arms and glides coordinate with the frame color
- Optional glides available

	A	B/COM	C	D	E	F	G	L3/COL	L4	L5
A00	\$412	\$442	\$462	\$497	\$527	\$562	\$597	\$572	\$622	\$692
A54	\$467	\$497	\$517	\$552	\$582	\$617	\$652	\$627	\$677	\$747

	ARMLESS	ARMS
WIDTH:	21.5	22.5
DEPTH:	21.0	21.0
HEIGHT:	36.0	36.0
SEAT WIDTH:	18.5	18.5
SEAT DEPTH:	16.0	16.0
SEAT HEIGHT:	18.5	18.5
BACK WIDTH:	18.0	18.0
BACK HEIGHT:	17.5	17.5
COM:	1.0 YD	1.0 YD
COL:	7.82 SQ FT	7.82 SQ FT
WEIGHT:	16.0 LB	18.0 LB



### ARM OPTIONS

CODE	DESCRIPTION	PRICE
<b>A54B</b>	Nylon Fixed Arm for sled models • Black	+\$55
<b>A54G</b>	Nylon Fixed Arm for sled models • Cloud Gray	+\$55



### FRAME COLORS - SLED

CODE	DESCRIPTION	PRICE
<b>SLDB</b>	Black	+\$0
<b>SLDS</b>	Silver	+\$0

### PLASTIC COLORS

CODE	DESCRIPTION	PRICE
<b>P01</b>	Black Swan	+\$0
<b>P05</b>	White Whisper	+\$0
<b>P11</b>	Federal Blue	+\$0
<b>P12</b>	Crimson Red	+\$0
<b>P13</b>	Lemon Yellow	+\$0
<b>P14</b>	Dove Gray	+\$0
<b>P15</b>	Cloud Gray	+\$0
<b>P16</b>	Lagoon Blue	+\$0
<b>P17</b>	Apple Green	+\$0
<b>P18</b>	Tangerine Orange	+\$0
<b>P19</b>	Latte	+\$0
<b>P20</b>	Azure Blue	+\$0

### ADDITIONAL OPTIONS

CODE	DESCRIPTION	PRICE
<b>G16</b>	Sled Base Clear Plastic Glide • 4 per seat	+\$15
<b>G17</b>	Sled Base Clear Plastic Glide with Felt • 4 per seat	+\$25

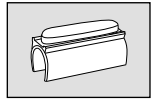
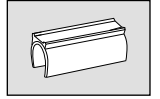

### ACCESSORIES

CODE	DESCRIPTION	PRICE
<b>GC8</b>	Ganging Clip • 2 per set, for Sled models • Arm-to-Arm and Armless-to-Armless • 2" Between Chairs when Ganged	+\$20
<b>DL5</b>	Stacking Dolly • Stacks up to 8 High - 4-Leg Models • Stacks up to 20 High - Sled Models	+\$399

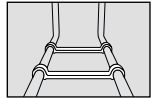

Due to the nature of upholstery, stacking may cause impressions on the seat. 9to5 Seating does not warrant effects of stacking on upholstery.



# Vox

CONTEMPORARY STACKING



## TASK

- Stacking side, guest, task and stool
- Flexback movement
- All plastic, upholstered seat or upholstered back and seat
- Pull handle for easy mobility
- Warranted to 300 lbs.

Webpage



GSA SIN # 33721 PENDING

MODEL / CHAIR TYPE / CONTROL	ARMS	MATERIAL									DIMENSIONS			
 <p><b>1090 / TSK / B1</b> Plastic Back - PB &amp; Plastic Seat - PS Task</p> <ul style="list-style-type: none"> <li>• 360° swivel</li> <li>• Pneumatic cylinder height adjustment</li> <li>• Stool options available for \$125 upcharge. See stool option section</li> </ul>		<b>P</b>										<b>ARMLESS</b>	<b>ARMS</b>	
	A00	\$429										WIDTH:	26.5	26.5
	A53	\$484										DEPTH:	26.5	26.5
												HEIGHT:	33.5	33.5
												SEAT WIDTH:	18.5	18.5
												SEAT DEPTH:	16.0	16.0
												SEAT HEIGHT:	16.0-20.5	16.0-20.5
												BACK WIDTH:	18.0	18.0
												BACK HEIGHT:	17.5	17.5
												COM:	N/A	N/A
												COL:	N/A	N/A
												WEIGHT:	28.0 LB	30.0 LB
 <p><b>1090 / TSK / B1</b> Plastic Back - PB &amp; Upholstered Seat - US Task</p> <ul style="list-style-type: none"> <li>• 360° swivel</li> <li>• Pneumatic cylinder height adjustment</li> <li>• Stool options available for \$125 upcharge. See stool option section.</li> </ul>		<b>A</b>	<b>B/COM</b>	<b>C</b>	<b>D</b>	<b>E</b>	<b>F</b>	<b>G</b>	<b>L3/COL</b>	<b>L4</b>	<b>L5</b>	<b>ARMLESS</b>	<b>ARMS</b>	
	A00	\$494	\$516	\$539	\$569	\$604	\$639	\$669	\$644	\$694	\$764	WIDTH:	26.5	26.5
	A53	\$549	\$571	\$594	\$624	\$659	\$694	\$724	\$699	\$749	\$819	DEPTH:	26.5	26.5
													HEIGHT:	33.5
												SEAT WIDTH:	18.5	18.5
												SEAT DEPTH:	16.0	16.0
												SEAT HEIGHT:	16.0-20.5	16.0-20.5
												BACK WIDTH:	18.0	18.0
												BACK HEIGHT:	17.5	17.5
												COM:	0.5 YD	0.5 YD
												COL:	3.91 SQ FT	3.91 SQ FT
												WEIGHT:	28.0 LB	30.0 LB
 <p><b>1090 / TSK / B1</b> Upholstered Back - UB &amp; Upholstered Seat - US Task</p> <ul style="list-style-type: none"> <li>• 360° swivel</li> <li>• Pneumatic cylinder height adjustment</li> <li>• Stool options available for \$125 upcharge. See stool option section.</li> </ul>		<b>A</b>	<b>B/COM</b>	<b>C</b>	<b>D</b>	<b>E</b>	<b>F</b>	<b>G</b>	<b>L3/COL</b>	<b>L4</b>	<b>L5</b>	<b>ARMLESS</b>	<b>ARMS</b>	
	A00	\$559	\$589	\$609	\$644	\$674	\$709	\$744	\$719	\$769	\$839	WIDTH:	26.5	26.5
	A53	\$614	\$644	\$664	\$699	\$729	\$764	\$799	\$774	\$824	\$894	DEPTH:	26.5	26.5
													HEIGHT:	33.5
												SEAT WIDTH:	18.5	18.5
												SEAT DEPTH:	16.0	16.0
												SEAT HEIGHT:	16.0-20.5	16.0-20.5
												BACK WIDTH:	18.0	18.0
												BACK HEIGHT:	17.5	17.5
												COM:	1.0 YD	1.0 YD
												COL:	N/A	N/A
												WEIGHT:	28.0 LB	30.0 LB



### ARM OPTIONS

CODE	DESCRIPTION	PRICE
<b>A53B</b>	Nylon Fixed Arm for task models • Black	+\$55
<b>A53G</b>	Nylon Fixed Arm for task models • Cloud Gray	+\$55



### FRAME COLORS - TASK

CODE	DESCRIPTION	PRICE
<b>TSKB</b>	Black	+\$0
<b>TSKS</b>	Silver	+\$0

### PLASTIC COLORS

CODE	DESCRIPTION	PRICE
<b>P01</b>	Black Swan	+\$0
<b>P05</b>	White Whisper	+\$0
<b>P11</b>	Federal Blue	+\$0
<b>P12</b>	Crimson Red	+\$0
<b>P13</b>	Lemon Yellow	+\$0
<b>P14</b>	Dove Gray	+\$0
<b>P15</b>	Cloud Gray	+\$0
<b>P16</b>	Lagoon Blue	+\$0
<b>P17</b>	Apple Green	+\$0
<b>P18</b>	Tangerine Orange	+\$0
<b>P19</b>	Latte	+\$0
<b>P20</b>	Azure Blue	+\$0

### STOOL OPTIONS

CODE	DESCRIPTION	PRICE
<b>CY30B</b>	8" Stool • (Seat Height: 22"-30") • Use for work surfaces up to 36" high	+\$125
<b>CY36B</b>	10" Stool • (Seat Height: 25"-36") • Use for work surfaces up to 42" high	+\$125



### BASE OPTIONS

CODE	DESCRIPTION	PRICE
<b>BA11B</b>	27" Mid-Profile Nylon Base • Black	+\$0
<b>BA12B</b>	27" Mid-Profile Aluminum Base • Black	+\$110
<b>BA12P</b>	27" Mid-Profile Aluminum Base • Polished	+\$110
<b>BA12S</b>	27" Mid-Profile Aluminum Base • Silver	+\$110

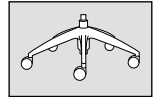
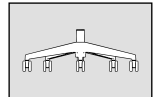

### CASTER OPTIONS

CODE	DESCRIPTION	PRICE
<b>C6</b>	Large Diameter Carpet Casters	+\$0
<b>C6S</b>	Large Diameter Hard Floor and Carpet Casters	+\$35
<b>C7</b>	Chrome-Accented Hard Floor and Carpet Casters	+\$35

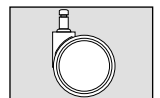
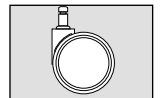
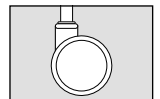



# Vox

CONTEMPORARY STACKING



## TASK

- Stacking side, guest, task and stool
- Flexback movement
- All plastic, upholstered seat or upholstered back and seat
- Pull handle for easy mobility
- Warranted to 300 lbs.

Webpage



GSA SIN # 33721 PENDING

MODEL / CHAIR TYPE / CONTROL	ARMS	MATERIAL									DIMENSIONS			
 <p><b>1090 / TSK / S3</b> Plastic Back - PB &amp; Plastic Seat - PS Task</p> <ul style="list-style-type: none"> <li>• Upright lock</li> <li>• Center knob tension adjustment</li> <li>• 360° swivel</li> <li>• Pneumatic cylinder height adjustment</li> <li>• Stool options available for \$125 upcharge. See stool option section.</li> </ul>		<b>P</b>										<b>ARMLESS</b>	<b>ARMS</b>	
	A00	\$464										WIDTH:	26.5	26.5
	A53	\$519										DEPTH:	26.5	26.5
												HEIGHT:	34.0	34.0
												SEAT WIDTH:	18.5	18.5
												SEAT DEPTH:	16.0	16.0
												SEAT HEIGHT:	16.5-21.0	16.5-21.0
												BACK WIDTH:	18.0	18.0
												BACK HEIGHT:	17.5	17.5
												COM:	N/A	N/A
												COL:	N/A	N/A
												WEIGHT:	17.5 LB	19.5 LB
 <p><b>1090 / TSK / S3</b> Plastic Back - PB &amp; Upholstered Seat - US Task</p> <ul style="list-style-type: none"> <li>• Upright lock</li> <li>• Center knob tension adjustment</li> <li>• 360° swivel</li> <li>• Pneumatic cylinder height adjustment</li> <li>• Stool options available for \$125 upcharge. See stool option section.</li> </ul>		<b>A</b>	<b>B/COM</b>	<b>C</b>	<b>D</b>	<b>E</b>	<b>F</b>	<b>G</b>	<b>L3/COL</b>	<b>L4</b>	<b>L5</b>	<b>ARMLESS</b>	<b>ARMS</b>	
	A00	\$529	\$551	\$574	\$604	\$639	\$674	\$704	\$679	\$729	\$799	WIDTH:	26.5	26.5
	A53	\$584	\$606	\$629	\$659	\$694	\$729	\$759	\$734	\$784	\$854	DEPTH:	26.5	26.5
													HEIGHT:	33.5
												SEAT WIDTH:	18.5	18.5
												SEAT DEPTH:	16.0	16.0
												SEAT HEIGHT:	16.0-20.5	16.0-20.5
												BACK WIDTH:	18.0	18.0
												BACK HEIGHT:	17.5	17.5
												COM:	0.5 YD	0.5 YD
												COL:	3.91 SQ FT	3.91 SQ FT
												WEIGHT:	28.0 LB	30.0 LB
 <p><b>1090 / TSK / S3</b> Upholstered Back - UB &amp; Upholstered Seat - US Task</p> <ul style="list-style-type: none"> <li>• Upright lock</li> <li>• Center knob tension adjustment</li> <li>• 360° swivel</li> <li>• Pneumatic cylinder height adjustment</li> <li>• Stool options available for \$125 upcharge. See stool option section.</li> </ul>		<b>A</b>	<b>B/COM</b>	<b>C</b>	<b>D</b>	<b>E</b>	<b>F</b>	<b>G</b>	<b>L3/COL</b>	<b>L4</b>	<b>L5</b>	<b>ARMLESS</b>	<b>ARMS</b>	
	A00	\$594	\$624	\$644	\$679	\$709	\$744	\$779	\$754	\$804	\$874	WIDTH:	26.5	26.5
	A53	\$649	\$679	\$699	\$734	\$764	\$799	\$834	\$809	\$859	\$929	DEPTH:	26.5	26.5
													HEIGHT:	34.0
												SEAT WIDTH:	18.5	18.5
												SEAT DEPTH:	16.0	16.0
												SEAT HEIGHT:	16.5-21.0	16.5-21.0
												BACK WIDTH:	18.0	18.0
												BACK HEIGHT:	17.5	17.5
												COM:	1.0 YD	1.0 YD
												COL:	N/A	N/A
												WEIGHT:	17.5 LB	19.5 LB



### ARM OPTIONS

CODE	DESCRIPTION	PRICE
<b>A53B</b>	Nylon Fixed Arm for task models • Black	+\$55
<b>A53G</b>	Nylon Fixed Arm for task models • Cloud Gray	+\$55



### FRAME COLORS - TASK

CODE	DESCRIPTION	PRICE
<b>TSKB</b>	Black	+\$0
<b>TSKS</b>	Silver	+\$0

### PLASTIC COLORS

CODE	DESCRIPTION	PRICE
<b>P01</b>	Black Swan	+\$0
<b>P05</b>	White Whisper	+\$0
<b>P11</b>	Federal Blue	+\$0
<b>P12</b>	Crimson Red	+\$0
<b>P13</b>	Lemon Yellow	+\$0
<b>P14</b>	Dove Gray	+\$0
<b>P15</b>	Cloud Gray	+\$0
<b>P16</b>	Lagoon Blue	+\$0
<b>P17</b>	Apple Green	+\$0
<b>P18</b>	Tangerine Orange	+\$0
<b>P19</b>	Latte	+\$0
<b>P20</b>	Azure Blue	+\$0

### STOOL OPTIONS

CODE	DESCRIPTION	PRICE
<b>CY30B</b>	8" Stool • (Seat Height: 22"-30") • Use for work surfaces up to 36" high	+\$125
<b>CY36B</b>	10" Stool • (Seat Height: 25"-36") • Use for work surfaces up to 42" high	+\$125



### BASE OPTIONS

CODE	DESCRIPTION	PRICE
<b>BA11B</b>	27" Mid-Profile Nylon Base • Black	+\$0
<b>BA12B</b>	27" Mid-Profile Aluminum Base • Black	+\$110
<b>BA12P</b>	27" Mid-Profile Aluminum Base • Polished	+\$110
<b>BA12S</b>	27" Mid-Profile Aluminum Base • Silver	+\$110

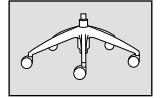
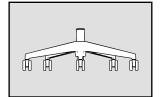

### CASTER OPTIONS

CODE	DESCRIPTION	PRICE
<b>C6</b>	Large Diameter Carpet Casters	+\$0
<b>C6S</b>	Large Diameter Hard Floor and Carpet Casters	+\$35
<b>C7</b>	Chrome-Accented Hard Floor and Carpet Casters	+\$35

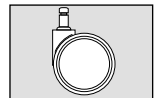
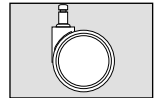
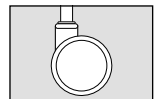





### ARM OPTIONS

CODE	DESCRIPTION	PRICE
<b>A53B</b>	Nylon Fixed Arm for task models • Black	+\$55
<b>A53G</b>	Nylon Fixed Arm for task models • Cloud Gray	+\$55



### FRAME COLORS - TASK

CODE	DESCRIPTION	PRICE
<b>TSKB</b>	Black	+\$0
<b>TSKS</b>	Silver	+\$0

### PLASTIC COLORS

CODE	DESCRIPTION	PRICE
<b>P01</b>	Black Swan	+\$0
<b>P05</b>	White Whisper	+\$0
<b>P11</b>	Federal Blue	+\$0
<b>P12</b>	Crimson Red	+\$0
<b>P13</b>	Lemon Yellow	+\$0
<b>P14</b>	Dove Gray	+\$0
<b>P15</b>	Cloud Gray	+\$0
<b>P16</b>	Lagoon Blue	+\$0
<b>P17</b>	Apple Green	+\$0
<b>P18</b>	Tangerine Orange	+\$0
<b>P19</b>	Latte	+\$0
<b>P20</b>	Azure Blue	+\$0

### STOOL OPTIONS

CODE	DESCRIPTION	PRICE
<b>CY30B</b>	8" Stool • (Seat Height: 22"-30") • Use for work surfaces up to 36" high	+\$125
<b>CY36B</b>	10" Stool • (Seat Height: 25"-36") • Use for work surfaces up to 42" high	+\$125



### BASE OPTIONS

CODE	DESCRIPTION	PRICE
<b>BA11B</b>	27" Mid-Profile Nylon Base • Black	+\$0
<b>BA12B</b>	27" Mid-Profile Aluminum Base • Black Powder Coat	+\$110
<b>BA12P</b>	27" Mid-Profile Aluminum Base • Polished	+\$110
<b>BA12S</b>	27" Mid-Profile Aluminum Base • Silver	+\$110

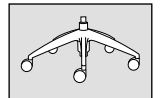
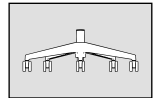

### CASTER OPTIONS

CODE	DESCRIPTION	PRICE
<b>C6</b>	Large Diameter Carpet Casters	+\$0
<b>C6S</b>	Large Diameter Hard Floor and Carpet Casters	+\$35
<b>C7</b>	Chrome-Accented Hard Floor and Carpet Casters	+\$35

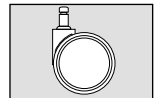
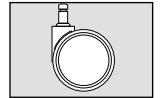
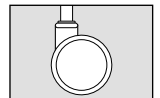



# Zoom

RAPID SETUP FOR A CREW  
OR A CROWD.

## NESTING

- Multipurpose seating, including nesting, task and task stool models
- Flex back with 10° of recline
- Mesh back with plastic or upholstered seat
- Warranted to 300 lbs.

Webpage



GSA SIN # 33721

### MODEL / CHAIR TYPE

### ARMS MATERIAL

### DIMENSIONS

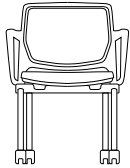

#### 1115 / FRM

Mesh Back - MB &  
Plastic Seat - PS

- Flex back movement of 10°
- Flip up seat for nesting and compact storage

	P										
A00	\$558										
A51	\$623										

	ARMS	ARMLESS
WIDTH:	24.0	24.0
DEPTH:	21.0	21.0
HEIGHT:	34.0	34.0
SEAT WIDTH:	17.5	17.5
SEAT DEPTH:	15.5	15.5
SEAT HEIGHT:	17.0	17.0
BACK WIDTH:	18.0	18.0
BACK HEIGHT:	19.0	19.0
COM:	N/A	N/A
COL:	N/A	N/A
WEIGHT:	20.0 LB	24.0 LB

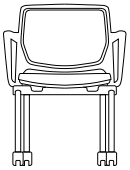

#### 1115 / FRM

Mesh Back - MB &  
Upholstered Seat - US

- Flex back movement of 10°
- Flip up seat for nesting and compact storage
- Molded foam seat

	A	B/COM	C	D	E	F	G				
A00	\$634	\$664	\$694	\$744	\$799	\$844	\$914				
A51	\$699	\$729	\$759	\$809	\$864	\$909	\$979				

	ARMS	ARMLESS
WIDTH:	24.0	24.0
DEPTH:	21.0	21.0
HEIGHT:	34.0	34.0
SEAT WIDTH:	17.5	17.5
SEAT DEPTH:	15.5	15.5
SEAT HEIGHT:	17.5	17.5
BACK WIDTH:	18.0	18.0
BACK HEIGHT:	19.0	19.0
COM:	0.9 YD	0.9 YD
COL:	N/A	N/A
WEIGHT:	21.0 LB	25.0 LB



## ARM OPTIONS

CODE	DESCRIPTION	PRICE
<b>A51</b>	Fixed Arm	+\$65



## FRAME COLORS

CODE	DESCRIPTION	PRICE
<b>NSTS</b>	Silver	+\$0
<b>NSTW</b>	White	+\$0

## PLASTIC AND MESH COLOR COMBINATIONS

CODE	FRAME	CODE	MESH	PRICE
<b>PGG</b>	Graphite Gray	<b>M32</b>	Slate Mesh	+\$0
<b>PWH</b>	White	<b>M33</b>	Snow Mesh	+\$0

## CASTER OPTIONS

CODE	DESCRIPTION	PRICE
<b>C5S</b>	Hard Floor and Carpet Casters	+\$30
<b>C12S</b>	Hard Floor and Carpet Casters	+\$0

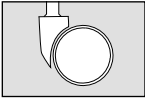
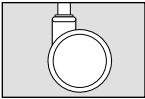
## NESTING FOOTPRINT



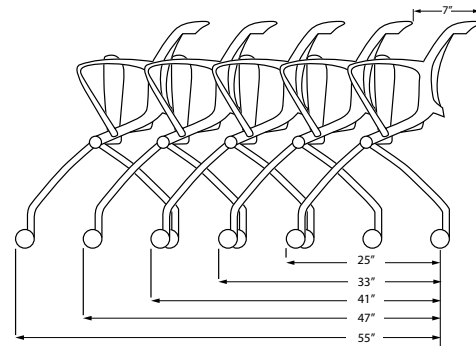

# Zoom

RAPID SETUP FOR A CREW  
OR A CROWD.

## TASK

- Multipurpose seating, including nesting, task and task stool models
- Flex back with 10° of recline
- Mesh back with plastic or upholstered seat
- Warranted to 300 lbs.

Webpage



GSA SIN # 33721

MODEL / CHAIR TYPE / CONTROL	ARMS	MATERIAL	DIMENSIONS	
------------------------------	------	----------	------------	--



### 1115 / TSK / B2

Mesh Back - MB &  
Plastic Seat - PS

- 360° swivel
- Pneumatic cylinder height adjustment

	P									
A00	\$658									
A51	\$723									

	ARMS	ARMLESS
WIDTH:	26.5	26.5
DEPTH:	26.5	26.5
HEIGHT:	35.0	35.0
SEAT WIDTH:	17.5	17.5
SEAT DEPTH:	16.5	16.5
SEAT HEIGHT:	17.0-22.0	17.0-22.0
BACK WIDTH:	18.0	18.0
BACK HEIGHT:	19.0	19.0
COM:	N/A	N/A
COL:	N/A	N/A
WEIGHT:	20.0 LB	24.0 LB



### 1115 / TSK / B2

Mesh Back - MB &  
Upholstered Seat - US

- 360° swivel
- Pneumatic cylinder height adjustment

	A	B/COM	C	D	E	F	G			
A00	\$734	\$764	\$794	\$844	\$899	\$944	\$1,014			
A51	\$799	\$829	\$859	\$909	\$964	\$1,009	\$1,079			

	ARMS	ARMLESS
WIDTH:	24.0	24.0
DEPTH:	21.0	21.0
HEIGHT:	34.0	34.0
SEAT WIDTH:	17.5	17.5
SEAT DEPTH:	15.5	15.5
SEAT HEIGHT:	17.5	17.5
BACK WIDTH:	18.0	18.0
BACK HEIGHT:	19.0	19.0
COM:	0.9 YD	0.9 YD
COL:	N/A	N/A
WEIGHT:	21.0 LB	25.0 LB



## ARM OPTIONS

CODE	DESCRIPTION	PRICE
<b>A51</b>	Fixed Arm	+\$65



## FRAME COLORS



CODE	DESCRIPTION	PRICE
<b>TSKS</b>	Silver	+\$0
<b>TSKW</b>	White	+\$0

## PLASTIC AND MESH COLOR COMBINATIONS

CODE	FRAME	CODE	MESH	PRICE
<b>PGG</b>	Graphite Gray	<b>M32</b>	Slate Mesh	+\$0
<b>PWH</b>	White	<b>M33</b>	Snow Mesh	+\$0

## STOOL OPTIONS

CODE	DESCRIPTION	PRICE
<b>CY30B</b>	8" Stool • (Seat Height: 22"-30") • Use for work surfaces up to 36"	+\$125
<b>CY36B</b>	10" Stool • (Seat Height: 25"-36") • Use for work surfaces up to 42"	+\$125

## BASE OPTIONS

CODE	DESCRIPTION	PRICE
<b>BA11G</b>	27" Mid-Profile Nylon Base • Graphite Gray	+\$0
<b>BA11W</b>	27" Mid-Profile Nylon Base • White	+\$0
<b>BA12P</b>	27" Mid-Profile Aluminum Base • Polished	+\$110



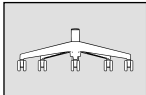
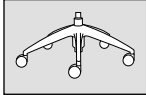



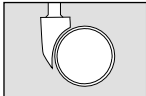

## CASTER OPTIONS

CODE	DESCRIPTION	PRICE
<b>C6</b>	Large Diameter Carpet Casters	+\$0
<b>C6S</b>	Hard Floor and Carpet Casters	+\$35

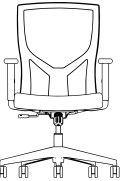

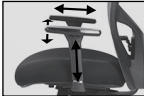
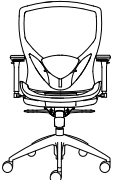
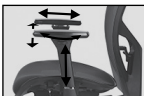

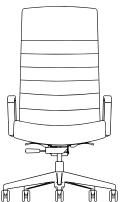

- Ships in 24 hours
- Task, conference and executive seating
- Bleach cleanable (10:1 solution) except HÅG SoFi seat fabric
- Five-year warranty
- Assembly required
- Warranted to 300 lbs.
- GREENGUARD Gold

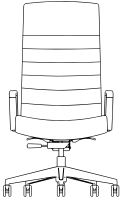

MODEL	PRICE	ARMS	TEXTILES	DIMENSIONS
 <p><b>146</b></p> <ul style="list-style-type: none"> <li>• Y1 - Simple Synchro</li> <li>• Height adjustable arms</li> <li>• Bleach cleanable (10:1 solution)</li> <li>• Ratchet back</li> <li>• Warranted to 300 lbs.</li> </ul>	\$816	 <p><b>A8B</b> Height adjustable</p>	<p><b>M21</b> BACK - Black Mesh</p> <p>SEAT - Black Air Grid Mesh</p>	<p>WIDTH: 24.5-26.0 DEPTH: 25.0 HEIGHT: 39.0-46.0 SEAT WIDTH: 20.0 SEAT DEPTH: 16.0-18.5 SEAT HEIGHT: 17.5-22.5 BACK WIDTH: 18.5 BACK HEIGHT: 23.0-25.5 WEIGHT: 40.5 LB</p>
 <p><b>205</b></p> <ul style="list-style-type: none"> <li>• Contemporary design</li> <li>• Y1-Simple synchro</li> <li>• Height adjustable arms</li> <li>• Bleach cleanable (10:1 solution)</li> <li>• 3" thick molded foam seat</li> <li>• Warranted to 300 lbs.</li> </ul>	\$596	 <p><b>A205</b> Height adjustable</p>	<p><b>M11</b> BACK - Black Mesh</p> <p>SEAT - Black Air Grid Mesh</p>	<p>WIDTH: 25.5 DEPTH: 24.5 HEIGHT: 36.0-41.0 SEAT WIDTH: 19.5 SEAT DEPTH: 17.5 SEAT HEIGHT: 16.0-20.5 BACK WIDTH: 19.0 BACK HEIGHT: 22.5 WEIGHT: 33.5 LB</p>
 <p><b>216</b></p> <ul style="list-style-type: none"> <li>• Y1-Simple synchro</li> <li>• Ratchet back w/ adjustable lumbar</li> <li>• 8-way adjustable arms</li> <li>• Bleach cleanable (10:1 solution)</li> <li>• 3" thick molded foam</li> <li>• Warranted to 300 lbs.</li> </ul>	\$844	 <p><b>A36</b> 8-way adjustable</p>	<p><b>M31</b> BACK - Graphite Mesh</p> <p>SEAT - Black Air Grid Mesh</p>	<p>WIDTH: 26.5 DEPTH: 26.5 HEIGHT: 38.5-45.5 SEAT WIDTH: 21.0 SEAT DEPTH: 20.0 SEAT HEIGHT: 17.5-22.0 BACK WIDTH: 20.5 BACK HEIGHT: 21.0-24.0 WEIGHT: 44.0 LB</p>
 <p><b>217</b></p> <ul style="list-style-type: none"> <li>• Y3-Full synchro</li> <li>• Ratchet back w/ adjustable lumbar</li> <li>• Bleach cleanable (10:1 solution)</li> <li>• 8-way adjustable arms</li> <li>• Polished aluminum base</li> <li>• Warranted to 300 lbs.</li> </ul>	\$973	 <p><b>A36</b> 8-way adjustable</p>	<p><b>M31</b> BACK - Graphite Mesh</p> <p><b>M31</b> SEAT - Graphite Mesh</p>	<p>WIDTH: 26.5 DEPTH: 26.5 HEIGHT: 39.0-46.0 SEAT WIDTH: 19.5 SEAT DEPTH: 18.0 SEAT HEIGHT: 17.5-22.0 BACK WIDTH: 20.5 BACK HEIGHT: 22.5-25.5 WEIGHT: 46.0 LB</p>
 <p><b>245</b></p> <ul style="list-style-type: none"> <li>• Contemporary design with channel stitching</li> <li>• S3-swivel tilt</li> <li>• Fixed chrome arms</li> <li>• Aluminum base</li> <li>• Bleach cleanable (10:1 solution)</li> <li>• Warranted to 300 lbs.</li> </ul>	\$1046	 <p><b>A24</b> Fixed Chrome Wraparound Arm</p>	<p>BACK - Pauly Black Vinyl</p> <p>SEAT - Pauly Black Vinyl</p>	<p>WIDTH: 21.5 DEPTH: 27.5 HEIGHT: 31.50-36.0 SEAT WIDTH: 19.0 SEAT DEPTH: 18.0 SEAT HEIGHT: 17.0-21.5 BACK WIDTH: 18.0 BACK HEIGHT: 16.5 COM: 2.0 YD COL: 19.0 SQ FT WEIGHT: 31.0 LB</p>
 <p><b>305</b></p> <ul style="list-style-type: none"> <li>• Sleek contemporary design</li> <li>• Y2 - Heavy Duty Synchro Tilt</li> <li>• Aluminum fixed arms with black arm pads</li> <li>• Bleach cleanable (10:1 solution)</li> <li>• Molded foam seat and back</li> <li>• Black nylon base</li> <li>• Warranted to 300 lbs.</li> </ul>	\$1,001	 <p><b>A52</b> Fixed Arm</p>	<p>BACK - Pauly Black Vinyl</p> <p>SEAT - Pauly Black Vinyl</p>	<p>WIDTH: 27.5 DEPTH: 24.5 HEIGHT: 42.0-47.0 SEAT WIDTH: 21.5 SEAT DEPTH: 16.5 SEAT HEIGHT: 17.0-21.5 BACK WIDTH: 20.0 BACK HEIGHT: 27.0 WEIGHT: 50.0 LB</p>

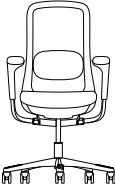
- Ships in 24 hours
- Task, conference and executive seating
- Bleach cleanable (10:1 solution) except HÅG SoFi seat fabric
- Five-year warranty
- Assembly required
- Warranted to 300 lbs.
- GREENGUARD Gold

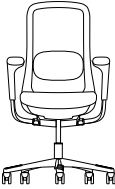

MODEL	PRICE	ARMS	TEXTILES	DIMENSIONS
 <p><b>306</b></p> <ul style="list-style-type: none"> <li>• Sleek contemporary design</li> <li>• Y2 - Heavy Duty Synchro Tilt</li> <li>• Aluminum fixed arms with black arm pads</li> <li>• Bleach cleanable (10:1 solution)</li> <li>• Molded foam seat and back</li> <li>• Polished aluminum base with chrome-accented casters</li> <li>• Warranted to 300 lbs.</li> </ul>	\$1064	 <p><b>A52</b> Fixed Arm</p>	<p>BACK - Pauly White Vinyl</p> <p>SEAT - Pauly White Vinyl</p>	<p>WIDTH: 27.5 DEPTH: 24.5 HEIGHT: 42.0-47.0 SEAT WIDTH: 21.5 SEAT DEPTH: 16.5 SEAT HEIGHT: 17.0-21.5 BACK WIDTH: 20.0 BACK HEIGHT: 27.0 WEIGHT: 50.0 LB</p>
 <p><b>750</b></p> <ul style="list-style-type: none"> <li>• HÅG in Balance mechanism (balanced, flowing tilt function)</li> <li>• Seat depth adjustment</li> <li>• Adjustable lumbar</li> <li>• Fully adjustable slideback arms</li> <li>• Black aluminum base</li> <li>• Limited lifetime warranty-same as 9to5 chairs</li> <li>• LEVEL 3 and GREENGUARD GOLD</li> <li>• Warranted to 300 lbs.</li> </ul>	\$1970	 <p><b>A56</b> Height/Width adjustment arms slide back to move closer to desk or table</p>	<p>BACK - Black Mesh</p> <p>SEAT - Gabriel - Black</p>	<p>WIDTH: 29.0 DEPTH: 29.0 HEIGHT: 50.0 SEAT WIDTH: 18.0 SEAT DEPTH: 18.5 SEAT HEIGHT: 15.5-21.5 BACK WIDTH: 18.0 BACK HEIGHT: 28.5 WEIGHT: 38.0 LB</p>
 <p><b>751</b></p> <ul style="list-style-type: none"> <li>• HÅG in Balance mechanism (balanced, flowing tilt function)</li> <li>• Seat depth adjustment</li> <li>• Adjustable lumbar</li> <li>• Fully adjustable slideback arms</li> <li>• Silver aluminum base</li> <li>• Limited lifetime warranty-same as 9to5 chairs</li> <li>• LEVEL 3 and GREENGUARD GOLD</li> <li>• Warranted to 300 lbs.</li> </ul>	\$1970	 <p><b>A56</b> Height/Width adjustment arms slide back to move closer to desk or table</p>	<p>BACK - Gray Mesh</p> <p>SEAT - Gabriel Select - Dark Gray</p>	<p>WIDTH: 29.0 DEPTH: 29.0 HEIGHT: 50.0 SEAT WIDTH: 18.0 SEAT DEPTH: 18.5 SEAT HEIGHT: 15.5-21.5 BACK WIDTH: 18.0 BACK HEIGHT: 28.5 WEIGHT: 38.0 LB</p>

# Arm Guide

## TASKING ARM OPTIONS

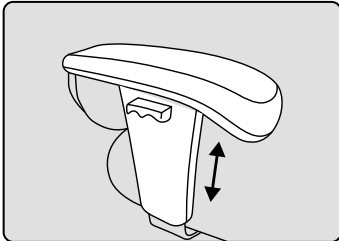

**A4**

**\$100**

**HEIGHT-ADJUSTABLE ARM**

Adjust the height by 3" with the underpad lever. The anti-skid arm pad features a diamond pattern.

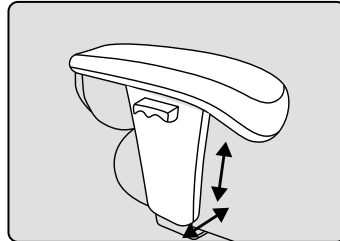

**A5**

**\$115**

**HEIGHT- AND WIDTH-ADJUSTABLE ARM**

Adjust the height by 3" with the underpad lever, and adjust the width by 4" with the underseat knob. The anti-skid arm pad features a diamond pattern.

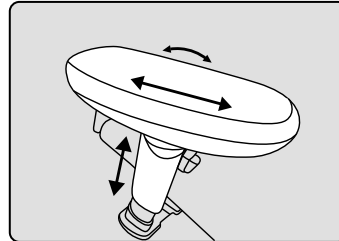

**A6**

**\$160**

**HEIGHT-ADJUSTABLE ARM WITH PIVOTING AND SLIDING PAD**

Adjust the height with the trigger. The polyurethane arm pad slides forward, backward, and pivots.

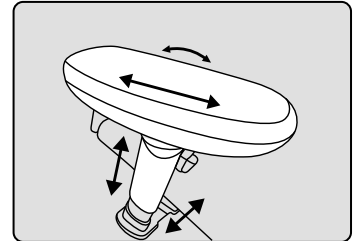

**A7**

**\$175**

**HEIGHT- AND WIDTH-ADJUSTABLE ARM WITH PIVOTING AND SLIDING PAD**

Adjust the height with the trigger, and adjust the width by 4" with the underseat knob. The polyurethane arm pad slides forward, backward, and pivots.

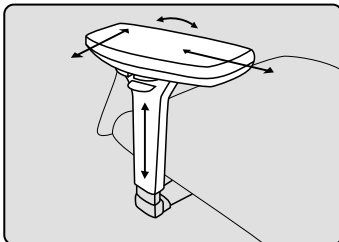

**A36**

**\$125**

**HEIGHT-ADJUSTABLE ARM WITH PIVOTING AND SLIDING PAD**

Adjust the height with the underpad lever. The soft-touch arm pad slides forward, backward, side to side, and pivots 23 degrees.

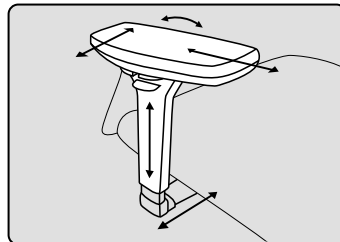

**A37**

**\$140**

**MULTI-ADJUST. PIVOT/SWIVEL**

Adjust the height with the underpad lever, and adjust the width with the underseat knob. The soft-touch arm pad slides forward, backward, side to side, and pivots 23 degrees.

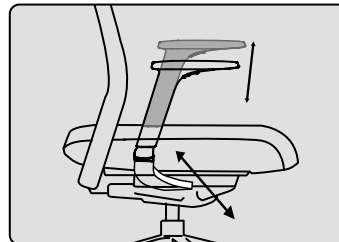

**A45**

**\$90**

**HEIGHT- AND WIDTH-ADJUSTABLE ARM**

Adjust the height with the trigger, and adjust the width using the underseat lever. Available in Black and Dove Gray. Exclusively on Luna.

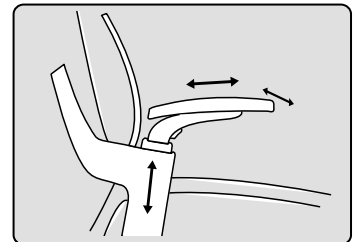

**A48**

**\$150**

**HEIGHT-ADJUSTABLE ARM WITH SLIDING PAD**

Adjust the height with the push button. The arm pad slides forward, backward, and side to side. Exclusively on Sol.

# Arm Guide

## TASKING ARM OPTIONS

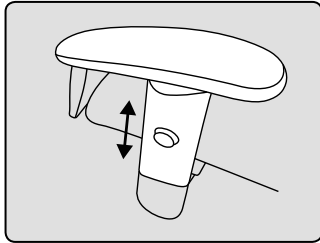

**A8**

**\$105**

**HEIGHT-ADJUSTABLE ARM**

Adjust the height by 3.5" with the push button. Available in Black and Silver.

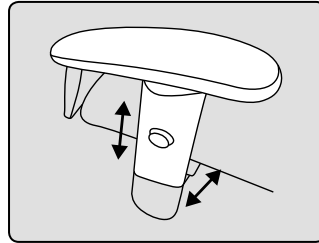

**A9**

**\$115**

**HEIGHT/WIDTH ADJUSTABLE ARM**

Adjust the height with the trigger and adjust the width by 4" with the under seat knob. Available in Black and Silver.

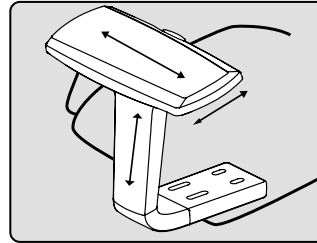

**A23**

**\$95**

**HEIGHT-ADJUSTABLE ARM WITH SLIDING PAD**

Adjust the height with the trigger. The arm pad slides forward, backward, and side to side. Available in Black, Graphite Gray, and White.

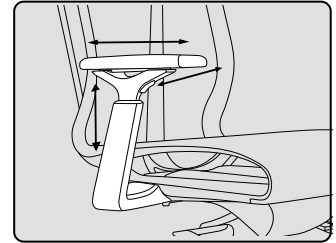

**A35**

**\$125**

**HEIGHT-ADJUSTABLE ARM WITH SLIDING PAD**

Adjust the height with the trigger. The arm pad slides forward, backward, and side to side. Available in Black, Graphite Gray, and White. Exclusively on Cydia.

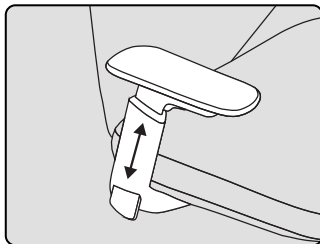

**A57**

**\$90**

**HEIGHT-ADJUSTABLE ARM**

Adjust the height by 4" with the trigger. Available in Black, Dove Gray and White.

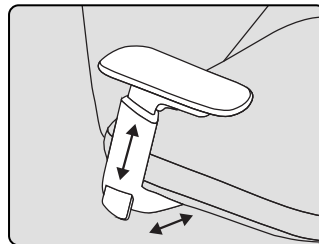

**A58**

**\$125**

**HEIGHT/WIDTH ADJUSTABLE ARM**

Adjust the height by 4" with the trigger and adjust the width using the underseat lever. Available in Black, Dove Gray and White.

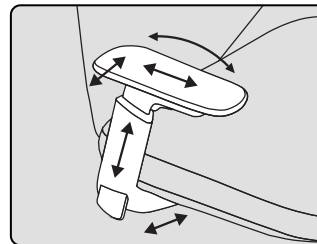

**A59**

**\$160**

**HEIGHT/WIDTH ADJUSTABLE ARM WITH PIVOTING AND SLIDING PAD**

Adjust the height by 4" with the trigger and adjust the width using the underseat lever. The pad slides forward, backward, side to side and pivots 25 degrees. Available in Black, Dove Gray and White.

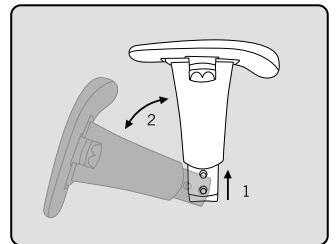

**A90**

**\$240**

**HEIGHT/WIDTH ADJUSTABLE BREAKAWAY ARM**

Adjust the height by 2.5" with the underpad lever and adjust the width using the underseat knob.

**PARTS AND ACCESSORIES DISCOUNT**

INDIVIDUAL PARTS & ACCESSORIES WHEN PURCHASED SEPARATE FROM A CHAIR RECEIVE AN EVEN 50% DISCOUNT.

THE 50% ACCESSORY DISCOUNT PROVIDES FOR EXTRA LABOR, PACKAGING MATERIAL AND SHIPPING CHARGES ASSOCIATED WITH SHIPPING A COMPONENT BY ITSELF.

# Arm Guide

## FIXED ARM OPTIONS

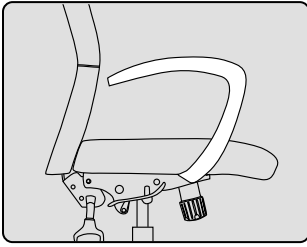

**A10**

**\$110**

**SOFT TOUCH CANTILEVER ARM**

Soft-touch cantilever arm. Available in Black.

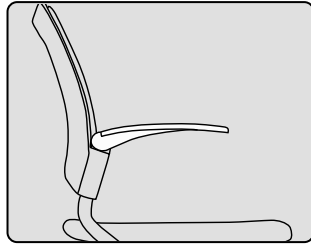

**A12**

**\$60**

**FIXED ARM**

Available in Black. Exclusively on Bella.

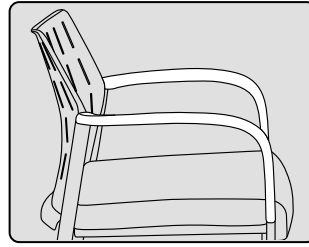

**A15**

**\$70**

**SOFT-TOUCH ARM**

Available in Black and Gray. Exclusively on Link.

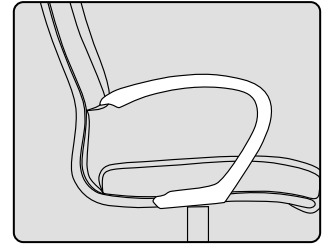

**A16**

**\$125**

**'C' ARM**

Soft-touch C-shaped arm. Available in Black.

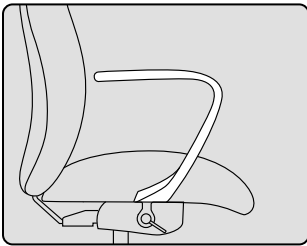

**A27**

**\$235**

**POLISHED ALUMINUM CANTILEVER ARM**

C-shaped polished aluminum arm with a matching upholstered arm pad. Exclusively on Acclaim.

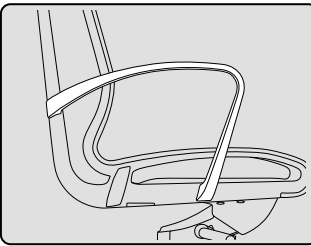

**A34**

**\$95**

**NYLON LOOP ARM**

Available in Black, Graphite Gray and White. Exclusively on Cydia.

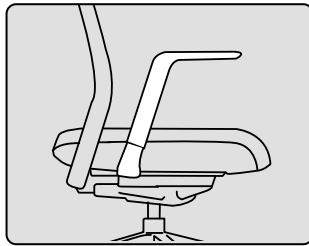

**A43**

**\$70**

**NYLON FIXED ARM**

Available in Black and Dove Gray.

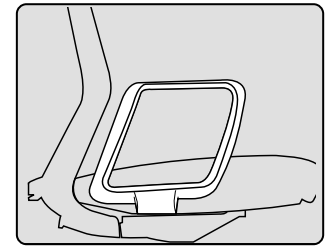

**A46**

**\$75**

**NYLON LOOP ARM**

Available in Black, Graphite Gray and White. Exclusively on Neo and Neo Lite.



**A53**

**\$55**

**NYLON FIXED ARM**

Available in Black and Cloud Gray. Exclusively on Dash and Vox 4 leg guest and task models.

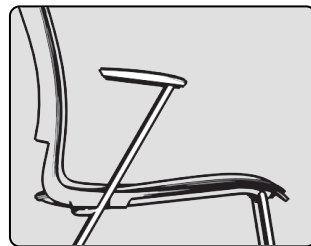

**A54**

**\$55**

**NYLON FIXED ARM**

Available in Black and Cloud Gray. Exclusively on Dash and Vox sled guest models.

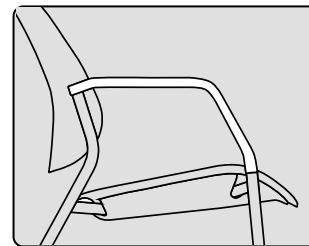

**A55**

**\$60**

**SOFT TOUCH POLYURETHANE ARM**

Available in Black and Gray. Exclusively used on Cavo guest, stool and bariatric models

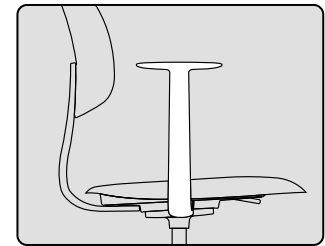

**A60**

**\$75**

**ALUMINUM FIXED ARMS**

Available in black, moss, tumbled, white, silver, blush rose, and polished. Exclusively on Tion.

# Arm Guide

## FIXED ARM OPTIONS

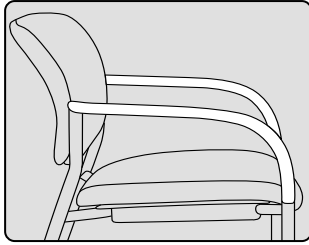

**A18**

**\$65**

**SOFT TOUCH POLYURETHANE ARM**

Available in Black and Gray. Exclusively on Shuttle.

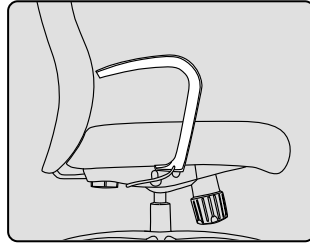

**A19**

**\$235**

**POLISHED CANTILEVER ARM**

C-shaped polished aluminum arm with a black urethane pad.

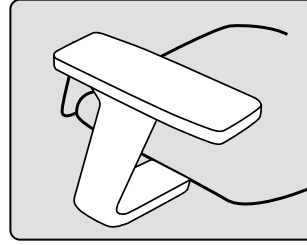

**A22**

**\$70**

**FIXED ARM WITH SOFT PAD**

Available in Black. Exclusively on Core.

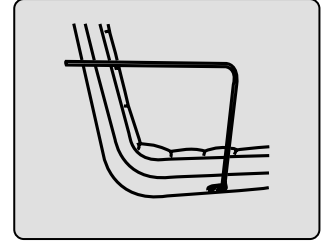

**A24**

**\$135**

**FIXED WRAPAROUND ARM**

Flat arms with a Black or Chrome finish that wrap around the chair back. Exclusively on Diddy.

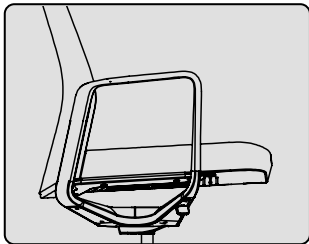

**A47**

**STD**

**FIXED ALUMINUM LOOP ARM WITH SOFT URETHANE PAD**

Sculpted aluminum arm that features a soft-touch urethane arm pad. Available in Silver and Polished Aluminum. Exclusively on Mila.

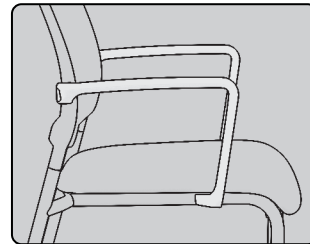

**A49**

**\$60**

**NYLON FIXED ARM**

Available in Black, Dove Gray and Graphite Gray. Exclusively on Clary and Luna side.

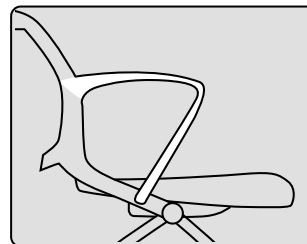

**A51**

**\$65**

**FIXED ARM**

Available in Graphite Gray and White. Exclusively on Zoom.

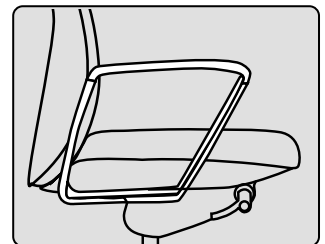

**A52**

**\$95**

**POLISHED ALUMINUM LOOP ARM**

Polished with black arm pad

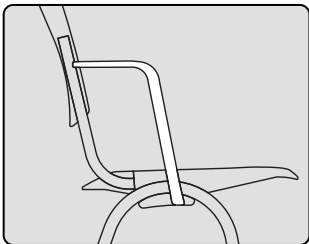

**A61**

**\$130**

**ALUMINUM FIXED ARMS**

Available in black, raw, blueberry, blush rose and silver. Exclusively on Celi.

**PARTS AND ACCESSORIES DISCOUNT**

INDIVIDUAL PARTS & ACCESSORIES WHEN PURCHASED SEPARATE FROM A CHAIR RECEIVE A 50% DISCOUNT, WHICH INCLUDES SHIPPING.

# Caster Guide

## PARTS AND ACCESSORIES DISCOUNT

INDIVIDUAL PARTS & ACCESSORIES WHEN PURCHASED SEPARATE FROM A CHAIR RECEIVE A 50% DISCOUNT, WHICH INCLUDES SHIPPING.

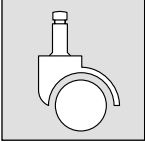
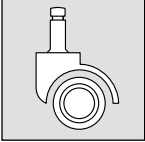
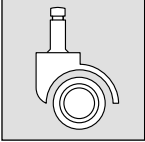
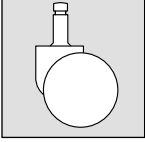
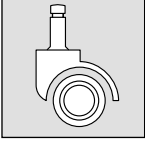
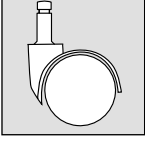
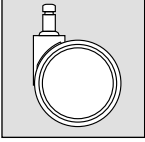
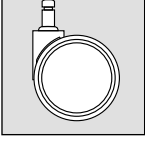
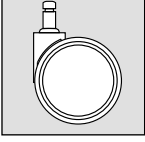
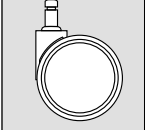
CODE	TYPE	SPECIFICATIONS	DESCRIPTION	PRICE	
<b>C1</b>	Carpet Casters	Hooded Twin Wheel Caster Wheel: 50 mm Barrel: 42 mm Load Rating: 110 lbs*	Best for use on carpeted surfaces. Hard nylon wheels are recommended for use on low-to-medium pile carpeting without padding. Dual wheels place more wheel surface on the carpet pile for optimum weight distribution. Wheels move in opposite directions to minimize carpet fiber twisting.	+\$25	
<b>C1S</b>	Hard Floor and Carpet Casters	Hooded Twin Wheel Caster Wheel: 50 mm Barrel: 42 mm Load Rating: 110 lbs*	Designed for use on carpet, hardwood floors, tile, chair mats, linoleum and concrete surfaces in an open office/workspace environment. (Lab, healthcare, classroom, and conference room.) Wheels are made from a soft polyurethane material. Set of five used with star bases.	+\$35	
<b>C2S</b>	Decompression Hard Floor and Soft Carpet Casters	Hooded Twin Wheel Caster Wheel: 50 mm Barrel: 42 mm Load Rating: 110 lbs*	Designed for use on carpet, hardwood floors, tile, chair mats, linoleum and concrete surfaces in an open office/workspace environment. (Lab, healthcare, classroom, and conference room.) Wheels are made from a soft polyurethane material. Set of five used with star bases. The wheels feature auto-lock; The safety brakes engage when the chair is not in use, this prevents the chair from rolling away when standing up.	+\$35	
<b>C4</b>	Heavy Duty Hard Wood Floor and Carpet Casters	Hoodless Twin Wheel Caster Wheel: 60 mm Barrel: 38 mm Load Rating: 140 lbs*	Recommended when higher weight capacity is required. Large diameter hard nylon wheels designed for use on low- to medium-pile carpeting with or without padding. Large diameter dual wheels place more wheel surface on the carpet pile for optimum weight distribution. Wheels move in opposite directions to minimize carpet fiber twisting.	+\$25	
<b>C5</b>	Carpet Casters	Hooded Twin Wheel Caster Wheel: 50 mm Barrel: 27 mm Load Rating: 110 lbs*	Best for use on carpeted surfaces. Hard nylon wheels are recommended for use on low- to medium-pile carpeting without padding. Dual wheels place more wheel surface on the carpet pile for optimum weight distribution. Wheels move in opposite directions to minimize carpet fiber twisting. Set of four used on guest chairs.	+\$30	
<b>C5S</b>	Hard Floor and Carpet Casters	Hooded Twin Wheel Caster Wheel: 50 mm Barrel: 13 mm Load Rating: 110 lbs*	Designed for use on carpet, hardwood floors, tile, chair mats, linoleum and concrete surfaces in an open office/workspace environment. (Lab, healthcare, classroom, and conference room.) Wheels are made from a soft polyurethane material. Set of four used on guest chairs.	+\$30	
<b>C6</b>	Large Diameter Carpet Casters - Black	Twin Wheel Caster Wheel: 60 mm Barrel: 25 mm Load Rating: 140 lbs*	Recommended for use on carpeted surfaces. Large diameter hard nylon wheels are recommended for use on low to medium pile carpeting with or without padding. 60 mm dual wheels place more wheel surface on the carpet pile for optimum weight distribution and ease of movement. Wheels move in opposite directions to minimize carpet fiber twisting.	+\$30	
<b>C6D</b>	Large Diameter Carpet Casters - Dove Gray	Twin Wheel Caster Wheel: 60 mm Barrel: 25 mm Load Rating: 140 lbs*	Recommended for use on carpeted surfaces. Large diameter hard nylon wheels are recommended for use on low to medium pile carpeting with or without padding. 60 mm dual wheels place more wheel surface on the carpet pile for optimum weight distribution and ease of movement. Wheels move in opposite directions to minimize carpet fiber twisting.	+\$30	
<b>C6S</b>	Large Diameter Hard Floor and Carpet Casters	Twin Wheel Caster Wheel: 60 mm Barrel: 25 mm Load Rating: 140 lbs*	Designed for use on carpet, hardwood floors, tile, chair mats, linoleum and concrete surfaces in an open office/workspace environment. (Lab, healthcare, classroom, and conference room.) Wheels are made from a soft polyurethane material. Set of five used with star bases.	+\$35	
<b>C6W</b>	Large Diameter Carpet Casters - White	Twin Wheel Caster Wheel: 60 mm Barrel: 25 mm Load Rating: 140 lbs*	Recommended for use on carpeted surfaces. Large diameter hard nylon wheels are recommended for use on low to medium pile carpeting with or without padding. 60 mm dual wheels place more wheel surface on the carpet pile for optimum weight distribution and ease of movement. Wheels move in opposite directions to minimize carpet fiber twisting.	+\$30	

\*Load Rating In (Lbs) Per Caster/Glide

# Caster Guide

## PARTS AND ACCESSORIES DISCOUNT

INDIVIDUAL PARTS & ACCESSORIES WHEN PURCHASED SEPARATE FROM A CHAIR RECEIVE A 50% DISCOUNT, WHICH INCLUDES SHIPPING.

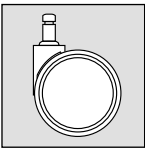
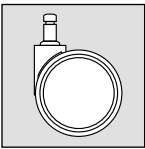
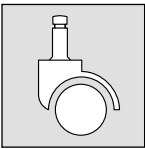
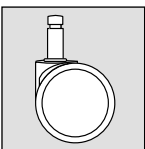
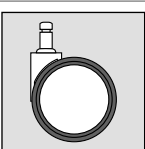
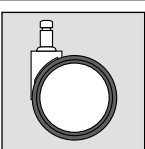
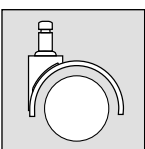
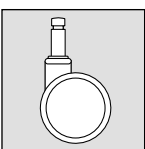
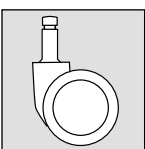
CODE	TYPE	SPECIFICATIONS	DESCRIPTION	PRICE	
<b>C7</b>	Chrome-Accented Hard Floor and Carpet Casters	Twin Wheel Caster Wheel: 60 mm Barrel: 25 mm Load Rating: 140 lbs*	Recommended for use on carpeted and hard floor surfaces. Large diameter hard nylon wheels are recommended for use on low to medium pile carpeting with or without padding and hard floors. 65mm dual wheels place more wheel surface on the carpet pile for optimum weight distribution and ease of movement. Wheels move in opposite directions to minimize carpet fiber twisting.	+\$35	
<b>C8S</b>	Large Diameter Hard Floor and Carpet Casters	Twin Wheel Caster Wheel: 75 mm Barrel: 22 mm Load Rating: 160 lbs*	Recommended for use on carpeted or hard surfaces. Large diameter soft nylon wheels are recommended for use on low to medium pile carpeting with or without padding. 75mm dual wheels place more wheel surface on floors for optimum weight distribution and ease of movement. Wheels move in opposite directions to minimize carpet fiber twisting.	+\$35	
<b>C9S</b>	Compression-Locking Hard Floor and Carpet Casters	Hooded Twin Wheel Caster Wheel: 50 mm Barrel: 42 mm Load Rating: 110 lbs*	Designed for use on carpet, hardwood floors, tile, chair mats, linoleum and concrete surfaces in an open office/workspace environment. (Lab, healthcare, classroom, and conference room.) The wheels feature compression-lock; The brakes engage when the user is seated in the chair. When seated this prevents the user from rolling away from the work surface.	+\$50	
<b>C10BS</b>	Decompression Hard Floor and Carpet Casters - Black	Twin Wheel Caster Wheel: 65 mm Barrel: 23 mm Load Rating: 110 lbs*	Designed for use on carpet, hardwood floors, tile, chair mats, linoleum and concrete surfaces in an open office/workspace environment. (Lab, healthcare, classroom, and conference room.) The wheels feature auto-lock; The safety brakes engage when the chair is not in use, this prevents the chair from rolling away when standing up.	+\$35	
<b>C10G</b>	Decompression Carpet Casters - Gray	Twin Wheel Caster Wheel: 60 mm Barrel: 25 mm Load Rating: 140 lbs*	Recommended for use on carpeted surfaces. The wheels feature a reverse compression lock to engage when the user is not seated in the chair. As the user lifts out of the chair, the caster prevents the chair from rolling away. Set of five used with star bases.	+\$35	
<b>C10GS</b>	Decompression Hard Floor and Carpet Casters - White and Gray	Twin Wheel Caster Wheel: 60 mm Barrel: 25 mm Load Rating: 140 lbs*	Recommended on hard and carpet floor surfaces. The wheels feature a reverse compression lock to engage when the user is not seated in the chair. As the user lifts out of the chair, the caster prevents the chair from rolling away. Set of five used with star bases.	+\$35	
<b>C11S</b>	Compression-Locking Hard Floor and Carpet Casters	Twin Wheel Caster Wheel: 50 mm Barrel: 18 mm Load Rating: 110 lbs*	Designed for use on carpet, hardwood floors, tile, chair mats, linoleum and concrete surfaces in an open office/workspace environment. (Lab, healthcare, classroom, and conference room.) The wheels feature compression-lock; The brakes engage when the user is seated in the chair. When seated this prevents the user from rolling away from the work surface.	+\$50	
<b>C12S</b>	Hard Floor and Carpet Casters	Twin Wheel Caster Wheel: 50 Mm Barrel: 16 Mm Load Rating: 110 Lbs*	Designed for use on carpet, hardwood floors, tile, chair mats, linoleum and concrete surfaces in an open office/workspace environment (Lab, healthcare, classroom and conference room). Can be used on carpet surfaces. Wheels are made of soft polyurethane material. Set of four used on guest or classroom chairs.	+\$25	
<b>C22B/G</b>	Hubless Hard Floor and Carpet Casters	Twin Wheel Caster Wheel: 60 Mm Barrel: 25mm Load Rating: 110 Lbs*	Recommend for use on Carpet or Hard floors. Wheels made of Polyurethane. Available in Black or Gray accents. Stylish hubless design.	+\$35	

\*Load Rating In (Lbs) Per Caster/Glide

# Control Selection Guide

## CONTROL FUNCTION GUIDE

1	INFINITE BACK ANGLE ADJUSTMENT	8	FORWARD TILT LEVER
2	SEAT HEIGHT LEVER	9	EASY-LIFT RATCHET BACK HEIGHT CONTROL
3	BACK DEPTH CONTROL KNOB	10	BACK MULTI-LOCK W/ SAFETY RELEASE
4	ARTICULATING POSTURE BACK W/ FREE FLOAT	11	SEAT SLIDER PADDLE
5	SEAT HEIGHT & TILT LOCK LEVER	12	4 POSITION BACK TRAVEL CONTROL
6	TILT TENSION CONTROL KNOB	13	UPRIGHT TILT LOCK
7	INFINITE POSITION TILT-LOCK		

## BASIC TASK

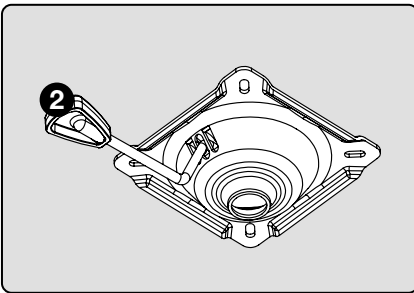

### B1 BASIC TASK

- 360° swivel
  - Pneumatic cylinder height adjustment
- Exclusively on Diddy, Dash Task and Vox Task.*

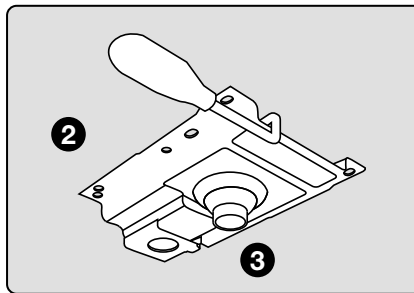

### B2 BASIC TASK WITH BACK DEPTH ADJUSTMENT

- Adjustable back depth
- 360° swivel
- Pneumatic cylinder height adjustment

## SWIVEL TILT

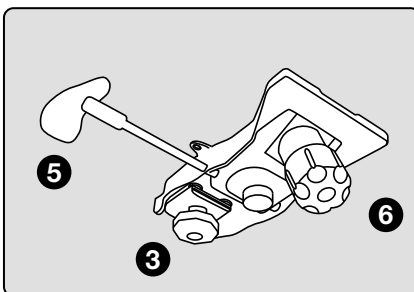

### S2 SWIVEL TILT WITH BACK DEPTH ADJUSTMENT

- Adjustable back depth
- Upright lock
- Center knob tension adjustment
- 360° swivel
- Pneumatic cylinder height adjustment

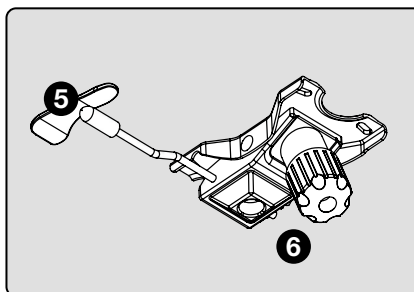

### S3 SWIVEL TILT

- Upright lock
- Center knob tension adjustment
- 360° swivel
- Pneumatic cylinder height adjustment

## POSTURE BACK

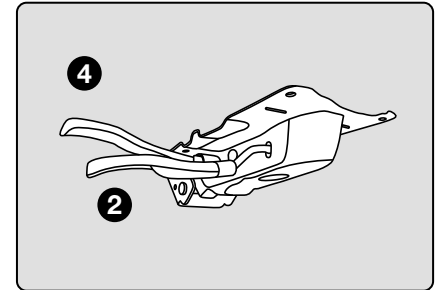

### P1 POSTURE BACK

- Infinite back angle adjustment with free float
- 360° swivel
- Pneumatic cylinder height adjustment

## KNEE TILT

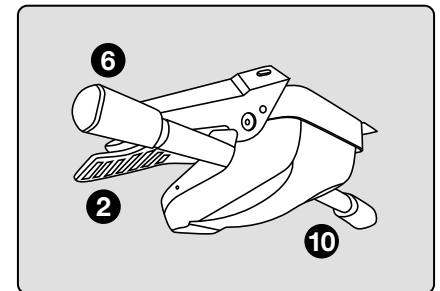

### K2 ADVANCED KNEE TILT

- 4-position tilt lock
  - Side knob tension adjustment
  - 360° swivel
  - Pneumatic cylinder height adjustment
- Exclusively on Core and Vault.*

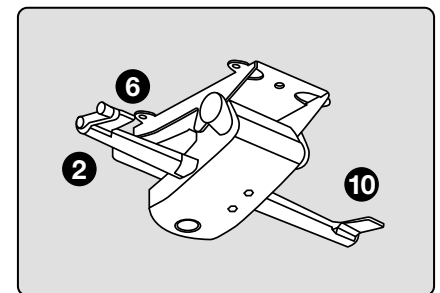

### K3 ADVANCED KNEE TILT

- 4-position tilt lock
  - Side knob tension adjustment
  - 360° swivel
  - Pneumatic cylinder height adjustment
- Exclusively on Cydia.*

# Control Selection Guide

## CONTROL FUNCTION GUIDE

1	INFINITE BACK ANGLE ADJUSTMENT	8	FORWARD TILT LEVER
2	SEAT HEIGHT LEVER	9	EASY-LIFT RATCHET BACK HEIGHT CONTROL
3	BACK DEPTH CONTROL KNOB	10	BACK MULTI-LOCK W/ SAFETY RELEASE
4	ARTICULATING POSTURE BACK W/ FREE FLOAT	11	SEAT SLIDER PADDLE
5	SEAT HEIGHT & TILT LOCK LEVER	12	4 POSITION BACK TRAVEL CONTROL
6	TILT TENSION CONTROL KNOB	13	UPRIGHT TILT LOCK
7	INFINITE POSITION TILT-LOCK		

### ROCKING TILT

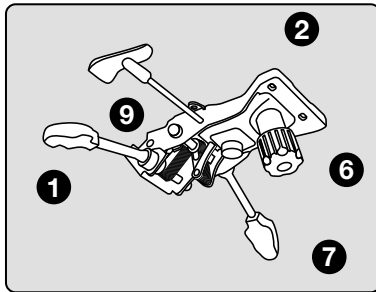

**R1**

**ROCKING TILT**

- Infinite back angle adjustment
- Infinite tilt lock
- Center knob tension adjustment
- 360° swivel
- Pneumatic cylinder height adjustment

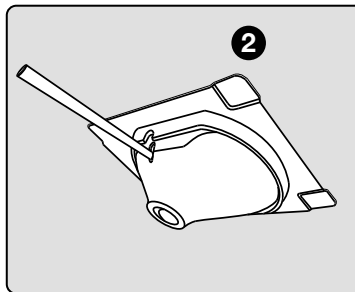

**R2**

**ROCKING TILT FOR LOUNGE AND GUEST**

- Rock left, right, front and back
  - 360° swivel
  - Pneumatic cylinder height adjustment
- Exclusively on Jax Side, Lilly Side, Diddy Guest, Dash Task and Vox Task.*

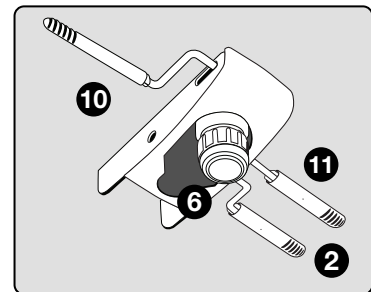

**R3**

**ROCKING TILT**

- Integrated seat slider
  - Upright lock
  - Center knob tension adjustment
  - 360° swivel
  - Pneumatic cylinder height adjustment
- Exclusively on HÅG Capisco and Capisco Puls.*

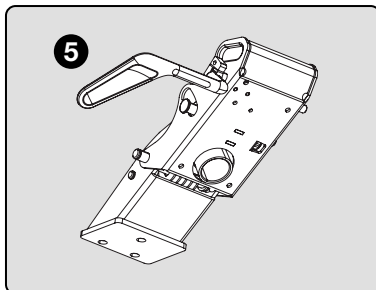

**R4**

- 360° swivel
- Upright tilt lock
- Pneumatic cylinder height adjustment
- Exclusively on Ellie

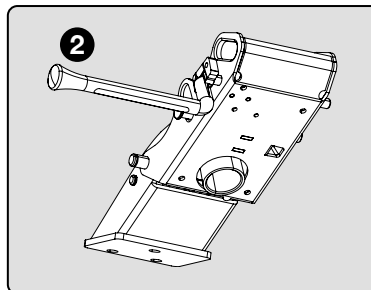

**R5**

- 360° swivel
- Pneumatic cylinder height adjustment
- Exclusively on Ellie

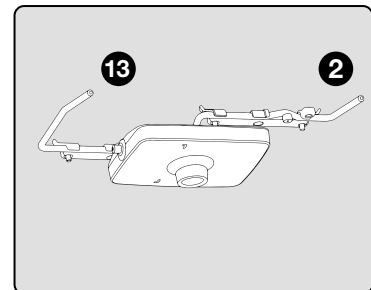

**R6**

- 360° swivel
- Pneumatic cylinder height adjustment
- Upright lock

# Control Selection Guide

## CONTROL FUNCTION GUIDE

1	INFINITE BACK ANGLE ADJUSTMENT	8	FORWARD TILT LEVER
2	SEAT HEIGHT LEVER	9	EASY-LIFT RATCHET BACK HEIGHT CONTROL
3	BACK DEPTH CONTROL KNOB	10	BACK MULTI-LOCK W/ SAFETY RELEASE
4	ARTICULATING POSTURE BACK W/ FREE FLOAT	11	SEAT SLIDER PADDLE
5	SEAT HEIGHT & TILT LOCK LEVER	12	4 POSITION BACK TRAVEL CONTROL
6	TILT TENSION CONTROL KNOB	13	UPRIGHT TILT LOCK
7	INFINITE POSITION TILT-LOCK		

## SYNCHRO TILT

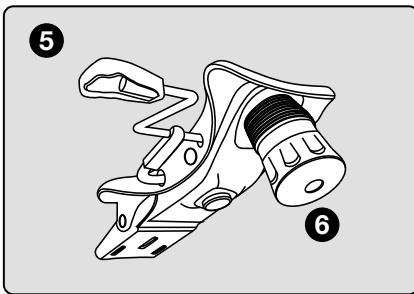

**Y1**

**SIMPLE SYNCHRO TILT**

- Upright tilt lock
- 3:1 back-to-seat tilt ratio
- Center knob tension adjustment
- 360° swivel
- Pneumatic cylinder height adjustment

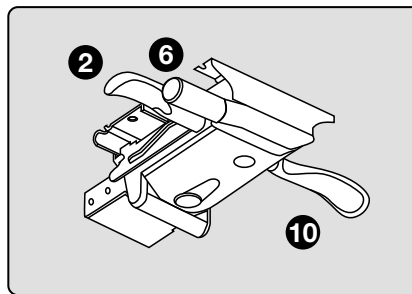

**Y2**

**HEAVY DUTY SYNCHRO TILT**

- 4-position tilt lock
- Side knob tension adjustment
- 2:1 back-to-seat tilt ratio
- 360° swivel
- Pneumatic cylinder height adjustment

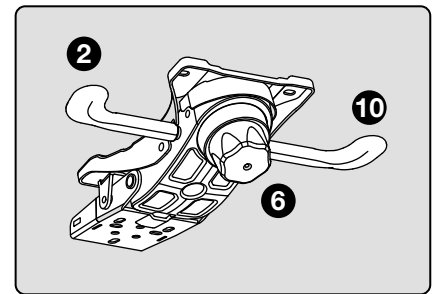

**Y3**

**FULL SYNCHRO TILT**

- 3-position tilt lock
- 2:1 back-to-seat tilt ratio
- Center knob tension adjustment
- 360° swivel
- Pneumatic cylinder height adjustment

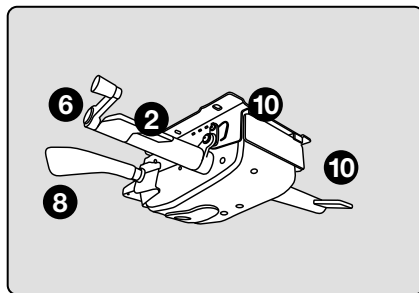

**Y4**

**INTENSIVE SYNCHRO**

- Integrated seat slider
- 4-position tilt lock
- 5° forward tilt
- Side knob tension adjustment
- 2:1 back-to-seat tilt ratio
- 360° swivel
- Pneumatic cylinder height adjustment

*Exclusively on Strata.*

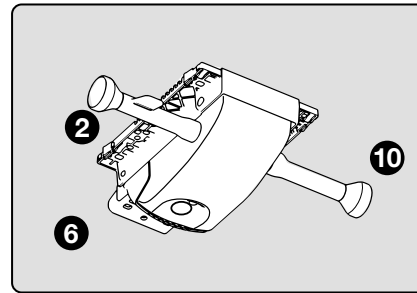

**Y6**

**DELUXE SYNCHRO TILT**

- 4-position tilt lock
- Side knob tension adjustment with 7 settings
- 2:1 back-to-seat tilt ratio
- 360° swivel
- Pneumatic cylinder height adjustment

*Exclusively on Sol and Tori.*

# Control Selection Guide

## CONTROL FUNCTION GUIDE

1	INFINITE BACK ANGLE ADJUSTMENT	8	FORWARD TILT LEVER
2	SEAT HEIGHT LEVER	9	EASY-LIFT RATCHET BACK HEIGHT CONTROL
3	BACK DEPTH CONTROL KNOB	10	BACK MULTI-LOCK W/ SAFETY RELEASE
4	ARTICULATING POSTURE BACK W/ FREE FLOAT	11	SEAT SLIDER PADDLE
5	SEAT HEIGHT & TILT LOCK LEVER	12	4 POSITION BACK TRAVEL CONTROL
6	TILT TENSION CONTROL KNOB	13	UPRIGHT TILT LOCK
7	INFINITE POSITION TILT-LOCK		

### WEIGHT-BALANCED

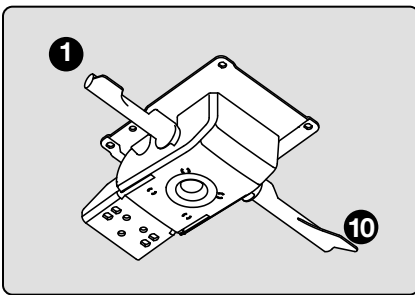

**W1**

#### WEIGHT-BALANCED SYNCHRO TILT

- Automatic tension adjustment
- 2-position tilt lock
- 3:1 back-to-seat tilt ratio
- 360° swivel
- Pneumatic cylinder height adjustment

*Exclusively on Core, Luna and Neo.*

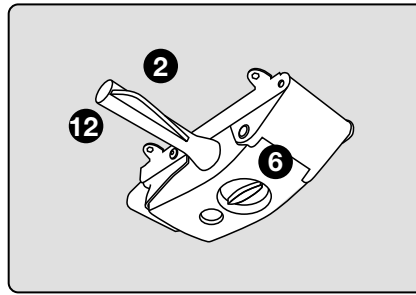

**W2**

#### ADVANCED WEIGHT-BALANCED SYNCHRO TILT

- Automatic tension adjustment with option to modify
- Tilt-limiter 4-position lock
- 3:1 back-to-seat tilt ratio
- 360° swivel
- Pneumatic cylinder height adjustment

*Exclusively on Acclaim and Luna.*

### MULTI-FUNCTION

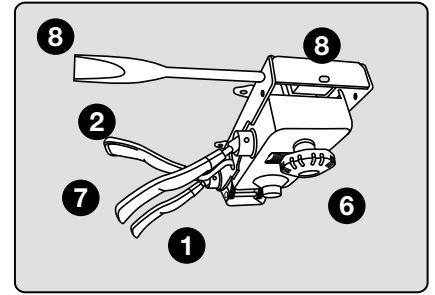

**M1**

#### MULTI-FUNCTION

- Infinite back angle adjustment
- 6° forward tilt
- Center knob tension adjustment
- 360° swivel
- Pneumatic cylinder height adjustment

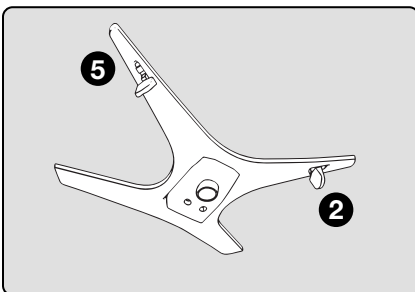

**Z1**

#### SIMPLE WEIGHT-BALANCED

- Automatic tension adjustment
- 12° recline or upright tilt lock
- 360° swivel
- Pneumatic cylinder height adjustment

*Exclusively on Mila.*

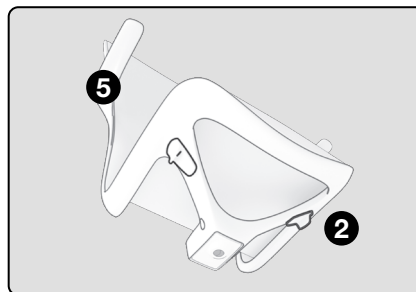

**Z2**

#### SIMPLE WEIGHT-BALANCED

- Automatic tension adjustment
- 9° recline or upright tilt lock
- 360° swivel
- Pneumatic cylinder height adjustment

*Exclusively on Omnia.*

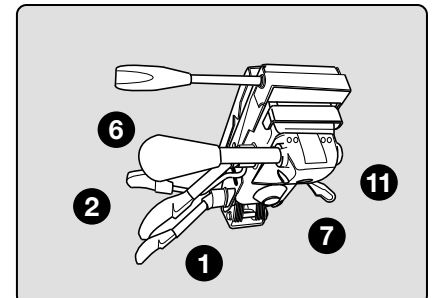

**M2**

#### HEAVY DUTY MULTI-FUNCTION

- Weight capacity up to 500 lbs.
- Integrated seat slider
- Infinite back angle adjustment
- 6° forward tilt
- Side knob tension adjustment
- 360° swivel
- Pneumatic cylinder height adjustment

*Exclusively on Logic Plus.*

# Controls by Series

	B1   B2   B3	P1	S2   S3	R1/R2/R3/R4/R5	K2   K3	Y1	Y2	Y3
	Basic	Posture Tilt	Swivel Tilt	Rocking Tilt	Knee Tilt	Simple Synchro	Heavy Duty Synchro Tilt	Full Synchro
Acclaim							✓	✓
Agent	✓	✓	✓	✓			✓	
Agent Stools	✓	✓						
Bella Task	✓		✓					
Bella Stools	✓							
Bristol		✓	✓	✓			✓	
Bristol Stools		✓						
Core					✓			
Core Stools								
Cortina			✓				✓	
Cydia			✓		✓			
Cydia Stools			✓					
Dash	✓		✓	✓				
Diddy	✓		✓	✓				
Ellie				✓				
HÅG Capisco				✓				
HÅG Capisco Puls				✓				
Jax Side				✓				
Lilly Side				✓				
Logic	Low-back	Low-, Mid-back	✓	✓			✓	
Logic Stools								
Logic Plus								
Luna						✓		✓
Luna Stools						✓		
Mila								
Neo Lite						✓		✓
Neo Lite Stools						✓		
Neo						✓		✓
Neo Stools						✓		
Omnia								
Omnia Stools								
Sol								
Strata							✓	
Strata Stools							✓	
Strata Lite						✓		
Strata Lite Stools						✓		
Theory						✓	✓	✓
Theory Stools						✓		
Tori						✓		
Vault					✓	✓		✓
Vault Stools						✓		
Vox	✓		✓	✓				
Zoom Task	✓		✓	✓				
Zoom Stools	✓							

# Controls by Series

	Y4	Y6	W1	W2	Z1   Z2	M1   M2	
	Intensive Synchro	Deluxe Synchro	Weight Balanced Synchro	Advanced Weight Balanced Synchro	Simple Weight Balanced	Multi-function	
Acclaim				✓			
Agent						✓	
Agent Stools							
Bella Task							
Bella Stools							
Bristol						✓	
Bristol Stools							
Core			✓				
Core Stools			✓				
Cortina						✓	
Cydia							
Cydia Stools							
Dash							
Diddy							
HÅG Capisco							
HÅG Capisco Puls							
Jax Side							
Lilly Side							
Logic						✓	
Logic Stools							
Logic Plus						✓	
Luna			✓	✓			
Luna Stools							
Mila					✓		
Neo Lite							
Neo Lite Stools							
Neo			✓				
Neo Stools							
Omnia					✓		
Omnia Stools					✓		
Sol		✓					
Strata							
Strata Stools							
Strata Lite	✓						
Strata Lite Stools							
Theory							
Tori		✓					
Theory Stools							
Vault							
Vault Stools							
Vox							
Zoom Task							
Zoom Stools							

# Parts Pricing

PRICES FOR INDIVIDUAL PARTS MAY BE LOWER WHEN PURCHASED ALONGSIDE A CHAIR CONFIGURATION.

## Bases

Model number	Description	
BA1B	26" Nylon - Black	\$75
BA1HD	26" Heavy Duty Nylon (Logic Plus) - Black	\$110
BA2B/S	26" Aluminum - Black, Silver	\$110
BA11B/G	27" Mid-Profile Nylon - Black, Graphite	\$75
BA12B/P/S	27" Mid-Profile Aluminum - Black, Polished, Silver	\$110
BA14P	26" Aluminum Four-Star - Polished	\$110
BA16B/P	27" Mid-Profile Aluminum - Polished	\$110
BA21B/S/W	26" Low-Profile Aluminum (HÅG Capisco & HÅG Capisco Puls) - Black, Silver, White	\$155
BA26B/D/W	27" Low Profile Nylon Base - Black, Dove Gray, White	\$75
BA27B/S/W	24.5" Low-Profile Aluminum (HÅG Tion) - Black, Silver, White	\$155
BA36P/S	27" Mid-Profile Aluminum (Sol 7 Tori) - Polished, Silver	\$110
Lilly Counter Frame	ST24 Frame Only - Black, Silver	\$190
Lilly Bar Frame	ST30 Frame Only - Black, Silver	\$210
FR18	18" Foot Ring (HÅG Capisco & HÅG Capisco Puls)	\$165
FR20	20" Foot Ring	\$90
JB1	Jury Base - Standard	\$300
G25B	Koble Adjustable Glides	\$35

## Cylinders

CY16	3" Lift	\$30
CY17	3" Lift	\$30
CY18	4" Lift	\$30
CY19	5" Lift	\$30
CY19H	5" Lift	\$30
CY20	5" Lift	\$30
CY20N	No Lift	\$30
CY24	5" Lift	\$30
CY30	8" Lift	\$30
CY36	10" Lift	\$30
CY9N	No Lift, Free Swivel (Lilly 9131/9134, Jax 9236/9231/9234)	\$30
CY9NA	No Lift, Auto-Return (Lilly 9131/9134, Jax 9236/9231/9234)	\$50
CY23	5.1" Lift (HÅG Capisco and HÅG Capisco Puls)	\$85
CY29	6.9" Lift (HÅG Capisco and HÅG Capisco Puls)	\$85
CY37	9.5" Lift (HÅG Capisco and HÅG Capisco Puls)	\$85
CYL-AHRB	5" Lift (For use with jury base option)	\$150

## Headrests

HR1	Strata, Strata Lite and Theory Headrest - Upholstered	\$85
HR2	Vault Headrest - M2 or M4	\$75
HDR-U8107-UPH	HÅG Capisco Headrest - Fabric - Black/Silver	\$250
HDR-U8107-UPH	HÅG Capisco Headrest - Leather - Black/Silver	\$320

## Accessories

DL5	Stacking Cart	\$399
DL6	Stacking Cart only for HÅG Celi	\$699
DL7	Stacking Cart only for Kelley and Kip	\$399
BRK	Book Rack (Shuttle)	\$70
GC1	Ganging Clip - For Bella, Clary, Luna and Shuttle Armless	\$30
GC2	Ganging Clip - For Bella, Clary, Luna and Shuttle Armed	\$30

# Parts Pricing

PRICES FOR INDIVIDUAL PARTS MAY BE LOWER WHEN PURCHASED ALONGSIDE A CHAIR CONFIGURATION.

## Accessories cont.

GC5	Ganging Clip - For Kelley and Kip Armless	\$20
GC7	Ganging Clip - For Dash and Vox 4-Leg Arm and Armless	\$30
GC8	Ganging Clip - For Dash and Vox Sled Arm and Armless	\$30
GC9	Ganging Clip - For Cavo Arm and Armless	\$30
PS	On Logic	\$50
BT	Bolt (B2, S2)	\$15
BN1/BN2	Upholstered Back w/Ballistic Nylon (Logic, Shuttle)	\$35
AW1	4" Arm Width Adjustment Bracket (A4, A6, A8, A36)	\$25

## Arm Pads

Please note that each arm pad is sold individually, not as a set of two.  
Some parts require a left or right specification.

ARM-P8000-101/102	Compatible with Sophie. Specify Black or Gray.	\$50
ARM-PAD22-101	Compatible with Core A22.	\$30
ARM-PAD33-L/R01	Compatible with Cosmo A33. Specify L or R.	\$30
ARM-PAD38-R/L01-V2	Compatible with Cosmo A38. Specify L or R.	\$30
ARM-PAD40-101	Compatible with A40.	\$30
ARM-PAD41-AS1	Compatible with A41.	\$30
ARM-PAD47L/R-P33	Compatible with Mila. Specify L or R.	\$30
ARM-PADA4-101	Compatible with A4, A5, A90.	\$20
ARM-PADA6-101	Compatible with A6, A7.	\$30
ARM-PADA8-101	Compatible with A8, A9.	\$25
ARM-PAD57-P01	Compatible with A57, A58, A59 in Black.	\$30
ARM-PAD57-P14	Compatible with A57, A58, A59 in Dove Gray.	\$30

## Controls

MEC-B0010-101	B1 Basic Task	\$50
MEC-B0020-101	B2 Basic Task with Depth Adjustment	\$50
MEC-P0010-101	P1 Posture Back	\$80
MEC-S0020-101	S2 Swivel Tilt with Back Depth Adjustment	\$60
MEC-S0030-101	S3 Swivel Tilt	\$60
MEC-R0010-101	R1 Rocking Tilt	\$70
MEC-R0020-000	R2 Rocking Tilt for Lounge and Guest	\$80
MEC-R0030-101	R3 Rocking Tilt	\$250
MEC-K0020-101-V5	K2 Advanced Knee Tilt	\$140
MEC-K0030-101	K3 Advanced Knee Tilt	\$140
MEC-Y0010-101	Y1 Simple Synchro Tilt	\$70
MEC-Y0020-101	Y2 Heavy Duty Synchro Tilt	\$130
MEC-Y0030-101	Y3 Full Synchro Tilt	\$90
MEC-Y0040-101	Y4 Intensive Synchro	\$160
MEC-Y0060-101	Y6 Deluxe Synchro Tilt	\$180
MEC-W0010-101	W1 Weight-Balanced Synchro Tilt	\$120
MEC-W0020-101	W2 Advanced Weight-Balanced Synchro Tilt	\$140
MEC-M0010-101	M1 Multi-Function	\$140
MEC-M02HD-101	M2 Heavy Duty Multi-Function	\$240

# Product Options

## HEAVY DUTY SEATING

	BRISTOL	CAVO BARIATRIC	CAVO GUEST	LOGIC	LOGIC PLUS	LUNA	KOBLE	SHUTTLE BARIATRIC	SOPHIE BARIATRIC	STRATA	THEORY	TORI
MODELS	2360-Y2 2380-Y2	1912	1910	1760-Y2 1760-M1 1780-Y2 1780-M1	1790-M2	3460-Y3	ANY MODEL	1250-GT	8119-GT	1560-Y2 1580-Y2	2160-Y2 2170-Y2 2180-Y2	3560-Y6 3580-Y6
WEIGHT CAPACITY	350 LBS.	750 LBS.	350 LBS.	350 LBS.	500 LBS.	350 LBS.	400 LBS.	600 LBS.	500 LBS.	350 LBS.	350 LBS.	350 LBS.
WARRANTY	10 YEARS MULTI-SHIFT	LIFETIME SINGLE-SHIFT	LIFETIME SINGLE-SHIFT	10 YEARS MULTI-SHIFT	10 YEARS SINGLE-SHIFT	10 YEARS MULTI-SHIFT	12 YEARS MULTI-SHIFT	LIFETIME SINGLE-SHIFT	12 YEARS MULTI-SHIFT	10 YEARS MULTI-SHIFT	10 YEARS MULTI-SHIFT	10 YEARS MULTI-SHIFT

## TASK SEATING OPTIONS

	Agent	Bristol	Core	Cydia	HÅG Capisco	HÅG Capisco Puls	Logic	Luna	Mila	Neo	Neo Lite	Sol	Strata	Strata Lite	Theory	Tori	Vault
Back Size																	
One Size			✓		✓	✓		✓	✓	✓	✓	✓					
Low-Back	✓						✓										
Mid-Back	✓	✓		✓			✓						✓	✓	✓	✓	✓
High-Back		✓		✓			✓						✓	✓	✓	✓	✓
Back Material																	
Knit Back									✓								
Mesh Back				✓				✓	✓	✓	✓	✓	✓	✓	✓	✓	✓
Upholstered Back	✓	✓	✓	✓	✓		✓		✓			✓				✓	
Plastic Back						✓											
Seat Material																	
Mesh Seat				✓									✓	✓	✓		
Upholstered Seat	✓	✓	✓	✓	✓	✓	✓	✓	✓	✓	✓	✓	✓	✓	✓	✓	✓
Models																	
Task Chair	✓	✓	✓	✓	✓	✓	✓	✓	✓	✓	✓	✓	✓	✓	✓	✓	✓
Task Stool	✓	✓	✓	✓	✓	✓	✓	✓		✓	✓		✓	✓	✓	✓	✓
Guest Chair								✓									
Lumbar																	
Height & Depth Adjustable													Standard	Standard			
Height Adjustable				Optional				Optional		Standard	Standard	Standard			Standard	Optional	
Ratchet Back	P1, R1, M1, Y2 Standard	Standard	Standard		Standard	Standard	P1, R1, M1, Y2 Standard								Standard		Standard
Frame Colors																	
Black			PBK	PBK	BF	BF		PBK	BF	PBK	PBK		BF	BF	BF	PBK	BF
Dove Gray								PDG								PDG	
Graphite Gray				PGG						PGG	PGG						
Silver					SF	SF						SF	SF				
White				PWH	WF	WF				PWH	PWH					PWH	
Polished Aluminum									PF			PF					

# Product Options

## MESH AND KNIT SELECTION

	M01	M1	M2	M3	M4	M6	KIP MESH	OMNIA MESH	KNIT KB
Bella		✓							
Clary		✓	✓	✓	✓				
Cydia		✓		✓					
Kip							✓		
Link		✓							
Luna			✓		✓				
Luna Side			✓		✓				
Mila			✓		✓				✓
Neo				✓	✓				
Neo Lite				✓					
Omnia								✓	
Shuttle		✓	✓	✓	✓				
Sol			✓		✓				
Strata	✓								
Strata Lite	✓								
Theory		✓							
Tori						✓			
Vault			✓		✓				
Zoom				M32 & M33					

# Glide Guide

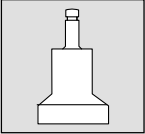
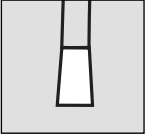
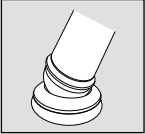
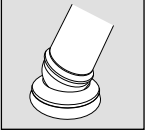
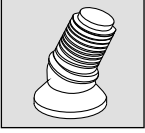
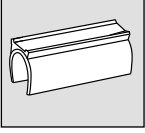
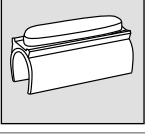
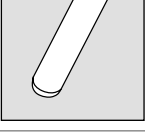
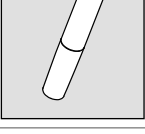
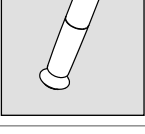
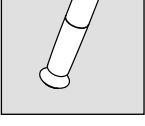
CODE	DESCRIPTION	LOAD RATING	SURFACE	CHAIRS	PRICE	
<b>G1</b>	Stationary Base Glide	110 LBS.	All Surfaces Except Hard Floors		+\$30	
<b>G3</b>	Tapered Plastic Glide	125 LBS.	All Surfaces	Bella	+\$20	
<b>G8</b>	Swivel Steel Glide	150 LBS.	Carpet	Jax, Lilly, Shuttle	+\$20	
<b>G9</b>	Swivel Nylon Glide	150 LBS.	All Surface	Jax, Lilly, Shuttle	+\$20	
<b>G10</b>	Swivel Felt Glide	110 LBS.	All Surfaces Except Carpet, Concrete, and Tile	Jax, Lilly, Shuttle	+\$20	
<b>G16</b>	Sled Base Clear Plastic Glide	90 LBS.	All Surfaces Except Carpet, VCT, and Wood	Dash, Kelley, Jax Wire, Lilly Stool, Lilly Wire, and Vox	+\$15	
<b>G17</b>	Sled Base Clear Plastic Glide with Felt	90 LBS.	All Surfaces Except Carpet, Concrete, and Tile	Dash, Kelley, Jax Wire, Lilly Stool, Lilly Wire, and Vox	+\$25	
<b>G18</b>	Dome Glide	125 LBS.	Carpet, Hard Floors	Jax, Lilly, Shuttle	+\$15	
<b>G19</b>	Tapered Plastic Glide	125 LBS.	Carpet, Hard Floors	Clary, Luna, Shuttle	+\$15	
<b>G19S</b>	Swivel Steel Glide	125 LBS.	Carpet	Clary, Luna, Shuttle	+\$20	
<b>G19N</b>	Swivel Nylon Glide	125 LBS.	All Surfaces	Clary, Luna, Shuttle	+\$20	

# Glide Guide

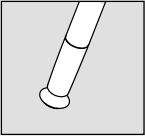
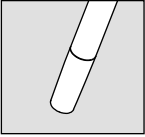
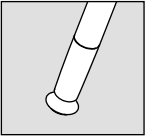
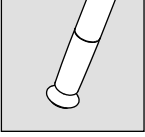
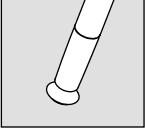
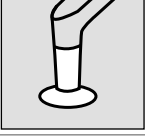
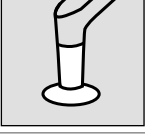
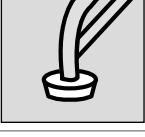
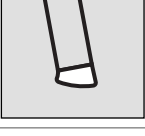
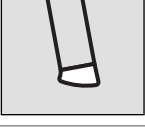
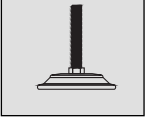
CODE	DESCRIPTION	LOAD RATING	SURFACE	CHAIRS	PRICE	
<b>G19F</b>	Swivel Felt Glide	125 LBS.	All Surfaces Except Carpet, Concrete, and Tile	Clary, Luna, Shuttle	+\$20	
<b>G21</b>	Tapered Plastic Glide	125 LBS.	Carpet, Hard Floors	Dash, Vox	+\$20	
<b>G21S</b>	Swivel Steel Glide	125 LBS.	Carpet	Dash, Vox	+\$20	
<b>G21N</b>	Swivel Steel Glide	125 LBS.	All Surfaces	Dash, Vox	+\$20	
<b>G21F</b>	Swivel Felt Glide	125 LBS.	All Surfaces Except Carpet, Concrete, and Tile	Dash, Vox	+\$20	
<b>G22F</b>	Stationary Felt Glide	125 LBS.	All Surfaces Except Carpet, Concrete, and Tile	Ellie	+\$25	
<b>G22T</b>	Stationary Teflon Glide	125 LBS.	All Surfaces	Ellie	+\$25	
<b>G23T</b>	Stationary Glide - Felt/Teflon	125 LBS.	All Surfaces	Ellie	+\$25	
<b>G24</b>	Nylon Glide	125 LBS.	All Surfaces	HÅG Celi	+\$20	
<b>G24F</b>	Nylon Glide Felt	125 LBS.	All Surfaces	HÅG Celi	+\$20	
<b>G25B</b>	Adjustable Glide	150 LBS.	All Surfaces	Koble	+\$30	

# BIFMA Ultimate Test for Fit (UTFF)

## ERGONOMICS - THE WORK CHAIR

The Business and Institutional Furniture Manufacturer's Association (BIFMA) has developed the following guidelines for UTFF. Parenthetical numbers following each item indicate corresponding subdivisions in the guidelines.

### Seat Height (7.1)

Users should be able to sit with their feet comfortably on the floor or footrest without undue pressure on the underside of the thighs. The thigh-to-torso angle should not be less than 90°.

### Seat Depth (7.2)

Users should be able to sit in the chair without undue pressure against the back of the knees, their back properly supported by the backrest and with adequate buttock and thigh support.

### Seat Width (7.3)

The seat should be wider than the hip breadth of the user with allowance for movement and clothing. The seat width should not limit the ability to use the armrests comfortably.

### Seat Pan Angle (7.4)

This should allow users to support their feet on the floor or footrest. They should not cause the user's torso-to-thigh angle to be less than 90°. Forward seat pan angles should not cause users to shift excessive weight to their feet or experience the sensation of sliding out of the chair.

## BACK SUPPORT (7.5)

### Seat Backrest Height (7.5.1)

All backrests should provide adequate support and buttocks clearance. For tasks requiring upper body mobility, the backrest should not interfere with the user's movement. For users who prefer reclining postures or greater upper back support, the back height should provide support for the shoulder blades.

### Backrest Width (7.5.2)

The width of the backrest should provide adequate support for the curvature of the user's back without causing localized pressure points.

### Lumbar Support (7.5.3)

The height and shape of the lumbar should coincide with the lumbar curve ("the small") of the user's back. The support should be firm, but not cause localized pressure points.

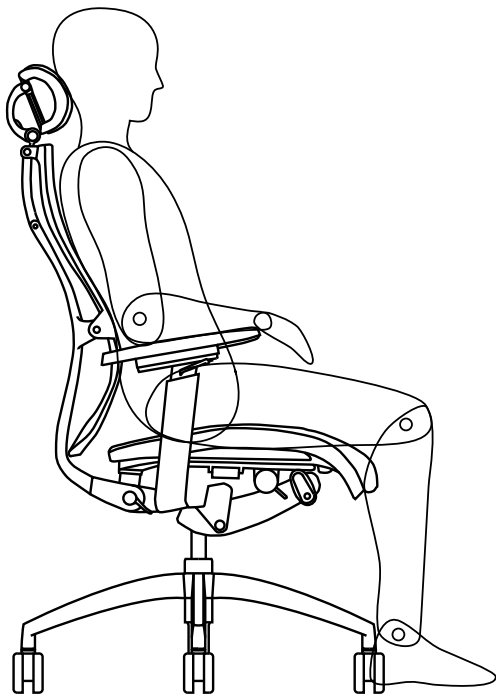

### Movements of the Seat Pan and Back Support (7.6)

The user should be able to sit in a position where the torso-to-thigh angle is equal to or greater than 90°. The seat and backrest angles should accommodate the varying postures assumed by the user throughout the day.

## ARM SUPPORT (7.7)

### Armrest Height (7.7.1)

This should allow users to sit in a variety of postures while supporting their forearms and/or elbows in a manner that avoids lifting the shoulders (armrests too high) or leaning to the side to reach the armrest (armrests too low). The armrest height should allow accessibility to, and performance of, tasks.

### Armrest Length (7.7.2)

The length of the armrest should allow users to sit close enough to the work surface to perform their tasks while maintaining contact with the backrest.

### Inside Distance Between Armrests (7.7.3)

Armrests should allow users to sit in a variety of postures while supporting their forearms in a manner that avoids lifting the shoulders and/or excessive outward positioning of the elbows. Armrests should allow accessibility to, and performance of, tasks. The inside distance between the armrests should allow the user to enter and exit the chair easily. The hips should comfortably fit between the armrests or supports.

# Care and Maintenance

- Ensure the gas cylinder is inserted into the control firmly. Improper connection may cause wobbling.
  - Choose correct casters for different floor surfaces. We suggest choosing hard floor casters for tile or concrete surfaces.
  - For drafting stool use, we recommend self-locking casters for hard floors. See Caster Guide for more details.
  - Do not stand on foot ring.
  - Do not sit on any part of the chair except the seat. Do not sit on arms or backrest.
  - To avoid chair collapse, do not remove knobs or screws.
  - Properly dispose of packing materials. Do not use plastic as head covering. It may cause suffocation.
  - If any parts are missing, broken, damaged or worn, do not use the chair until repairs are made using factory-authorized parts.
  - Do not attempt to make any alterations to chair.
  - Do not use chair on uneven floor surfaces.
  - Do not drape coats or sweaters on back of chairs with casters. Hanging fabric may suddenly stop casters from rolling.
  - Do not use excessive speed when moving the chair with casters while seated.
  - Do not overexert the functions of a chair which are only to be used under normal conditions.
  - Do not stand on and/or use this chair as a stepladder. Use this product only for seating one person at a time.
  - Do not use this chair unless all bolts, screws and knobs are firmly secured.
- Check the following at 4 month intervals;**
- All exposed fasteners should be checked and any loose fasteners tightened. Use appropriate tools. Replace any fasteners that appear to be damaged in any way.
  - The chair mechanism should be checked for any looseness, excessive wear or signs of damage. Immediately remove the chair from service if any damage or failure is found.
  - The base and casters should be checked for any signs of excessive wear for failure. Immediately replace any parts that show such wear or failure.

Choose from over 1,000 textiles offered by C.F. Stinson, Designtex, Maharam, Momentum, and 9to5 Seating's Signature, Breeze and Nautilus Cards. In the rare case we don't have what you're looking for, we'll upholster your chair in any fabric provided to us!

**Lifetime Warranty** on all structural and mechanical components. Fabric and foam are warranted against wear through and deterioration for five years.

Part of the Flokk Group



Additional Product Materials

Webpage 



3D Models 

Photo Collection 

9to5seating.com  
3211 Jack Northrop Ave.  
Hawthorne, CA 90250

P: 888.925.SEAT  
F: 866.925.SEAT  
E: sales@9to5seating.com

Follow us @9to5seating

