



3211 Jack Northrop Avenue
Hawthorne, CA 90250
P. 888.925.SEAT F. 866.925.SEAT
E. sales@9to5seating.com



9to5seating.com | Follow us @9to5seating



PRICES EFFECTIVE JANUARY 1, 2024
Please refer to our online price book at 9to5seating.com/download for the latest changes including product drops and additions.

Part of the Flokk Group
9to5[®] seating **@NCE**
from 9to5 Seating

© 2024 9to5 Seating LLC

2024 Price List



9to5[®] seating

2024 Price List

EFFECTIVE JANUARY 1, 2024

table of contents

INFORMATION

2	about 9to5 Seating
3	green practice
4	lifetime warranty
6	general information
7	condition of sale
8	dimensions / lead time
10	order procedure
11	packaging codes / upholstery selection
12	customer material program
13	customer's own material/leather form
14	CAL TB 133 fire code
15	two tone option
16	custom embroidery submission form

SEATING PRODUCTS

18	new for 2024
20	acclaim: 2780
22	agent: 1425, 1426, 1428, 1660, 1666, 1668
34	bella: 1310, 1315, 1320, 1325, 1326, 1328, 1360, 1365, 1370, 1375, 1376, 1378
52	bristol: 2360, 2366, 2368, 2380
58	cavo: 1910,1912
66	clary: 1510
68	core: 2260, 2266, 2268
72	cortina: 2900, 2910
76	cosmo: 3250, 3260, 3220, 3230
80	cydia: 3300, 3306, 3308, 3310
88	dash: 1130, 1131, 1134, 1135
100	diddy: 2450
102	ellie: 9360, 9380
106	HÅG capisco: 8105, 8106, 8126
108	HÅG capisco puls: 8001, 8002, 8010, 8020
110	HÅG celi: 1150
112	HÅG tion: 2100, 2120
114	jax: 9201, 9204, 9206, 9211, 9214, 9216, 9221, 9224, 9226, 9231, 9234, 9236, 9254, 9264
120	kelley: 1060, 1066, 1070, 1076
128	kip: 1080, 1081
132	koble: 9300, 9301, 9303, 9310, 9311, 9312, 9320, 9321, 9322, 9323, typicals
138	lilly: 9101, 9104, 9111, 9121, 9124, 9131, 9114, 9134, 9154, 9164, 9165
144	link: 1410, 1415
150	logic: 1725, 1726, 1728, 1760, 1766, 1768, 1780, 1790
164	luna: 3460, 3461, 3466, 3468
170	mila: 3760
172	neo: 3160, 3166, 3168
174	neo lite: 3150, 3156, 3158
176	omnia: 2860, 2866, 2868
178	shuttle: 1210, 1215, 1230, 1250, 1260, 1265, 1280
198	sol: 3680
200	sophie: 8111, 8112, 8113, 8118, 8119, 8122, 8123, 8102, 8103, 8104
206	sophie tables: 8170, 8190, 8191, 8192, 8193
208	strata: 1560, 1566, 1568, 1580, 1570, 1576, 1578, 1590
212	strata lite: 1535, 1536, 1537, 1538, 1545, 1555
220	theory: 2160, 2166, 2168, 2170, 2176, 2178, 2180, 2190
228	tori: 3560, 3580
232	vault: 1460, 1466, 1468, 1480
236	vox: 1090, 1091, 1094, 1095
260	zoom: 1115, 1125, 1126, 1128
268	zoom: 1115, 1125, 1126, 1128

ACCESSORIES

270	arm guide
274	caster guide
276	control selection guide
280	controls by series
282	parts pricing
284	product options
286	glide guide
287	BIFMA ultimate test for fit (UTFF)
288	care and maintenance instructions
289	notes

about 9to5 Seating

Sit Down and Get Comfortable

Sit down and get comfortable. While sitting comes naturally, there's much more to the "get comfortable" part of this saying. It might take a simple height adjustment or a slide of the seat pan, but if the price of the chair does not align with your budget, it'll never be the right fit for you. Our team of industrial designers, engineers, and manufacturing automation specialists is constantly improving the product and discovering efficiencies in processes, resulting in greater value and shorter lead times. From task to lounge, we are designing and delivering chairs that are as gorgeous as they are functional, yet most find the quality most attractive. When comparing seating, fit and finish is often a pretty good indicator of price, but with us that's not the case. Our chairs are often perceived to be much more expensive than they are. Innovation, along with unmatched manufacturing prowess, is why other brands only talk about quality while we're able to back it up with one of the best warranties in the industry. Not only will you be comfortable specifying 9to5 Seating, you'll be able to relax, knowing the customer will be sitting pretty for years to come.

Designed to Be Accessible

At 9to5 Seating, we place a strong emphasis on design and accessibility. Our efforts are laser-focused on one thing: improving efficiencies and the performance of seating. Our industrial design thinking, engineering forte, manufacturing automation, vertical integration, and sourcing savvy enable us to deliver quality, beautiful seating products that won't break the budget. Our chairs are built to be accessible, and that's just one of the reasons for our continued growth. Pair that with our award-winning designs and overall high quality, and it becomes easy to see why we're a favorite choice among both designers and facility managers.

Customers, Please Take a Seat

Customers are at the heart of everything we do. Whether it's the occupants of the space, facility managers, interior designers, or furniture dealers, our passion is the relentless effort to please. In addition to great service, we have specialists in the field and at our headquarters, we invest in advanced technologies throughout our operations, which enables clients to configure products, order, track, and service with the utmost accuracy and shorter lead times. From the first meeting and throughout your relationship with 9to5 Seating, you can truly sit back and relax.

Ahead of the Curve

At 9to5 Seating, we know that the pace of change is always accelerating. Our culture is one of innovation. It's in our atmosphere. Some say it's our forward-thinking California team, our constant exploration of what's next in design and technology, or the fact that we're a part of Flokk, the European leader in seating brands. We say it's all of those things and more. Bottom line: We do it so you can rely on 9to5 Seating to consistently deliver industry-leading innovations engineered to align with the needs of an ever-changing market.



RESPONSIBLE

We are dedicated to eco-friendly and sustainable manufacturing practices.



FORWARD THINKING

We believe in staying ahead of the curve when it comes to manufacturing and design.



UNCOMPROMISING

We never settle. We insist on sourcing our own materials, utilizing cutting-edge technology, providing superior value, and satisfying our customers completely.



ROCK SOLID

We have built top-quality products for more than 16 years - chairs that are built to last.



CUSTOMIZATION

We allow our customers to customize their chairs to best suit their style and needs.

green practice

9to5 Seating Commits to Thinking & Acting Green

9to5 Seating is committed to sustainable and environmentally responsible business practices. This global perspective is endorsed and executed throughout every aspect of our corporate culture, and within our warehousing, manufacturing and office facilities. We are proud to demonstrate our commitment by offering GREENGUARD GOLD Certified products, participating in the U.S. Environmental Protection Agency's WasteWise Program, achieving LEED® NC Gold Certification for our corporate headquarters facility and achieving BIFMA's LEVEL sustainability certification program for furniture.

Environmental Commitment in Action

9to5 Seating's corporate headquarters uses a rooftop photovoltaic panel system to generate electricity for the facility. To view how much power we are generating in real time, visit our solar portal at www.9to5seating.com.

Over 30 years, the system will offset:

- 6,102,370 lbs. of CO2 | a leading cause of global climate change
- 4,192 lbs. of NOx | a leading cause of smog
- 1,048 lbs. of SO2 | a leading cause of acid rain
- 1,215 lbs. of particulates | a leading cause of asthma

6,102,370 lbs. of CO2 is equivalent to the amount absorbed by 13 acres of trees over their lifetime

LEVEL, GREENGUARD GOLD and LEED® Certified

9to5 Seating is committed to sustainable and environmentally responsible business practices. This global perspective is endorsed and executed throughout every aspect of our corporate culture, and within our warehousing, manufacturing and office facilities. 9to5 Seating chairs are BIFMA LEVEL 2 certified. HÅG Capisco and Puls, HÅG SoFi and Ellie are BIFMA LEVEL 3 certified.

Developed by the Business and Institutional Furniture Manufacturer's Association (BIFMA), LEVEL is a voluntary certification program in which third-party auditors measure a product and its producer against the ANSI/BIFMA e3 Furniture Sustainability Standard. The LEVEL program was created to provide the most comprehensive, unbiased and transparent means of evaluating and communicating the environmental and social impacts of commercial furniture products. The LEVEL mark demonstrates that the product, the manufacturing facility, and the company responsible for the product brand, have all met the requirements for certification. Visit www.levelcertified.org for more information.

Our entire product line earned GREENGUARD GOLD Indoor Air Quality Certification issued by the GREENGUARD Environmental Institute. The program assures that products designed for use in office environments and other indoor spaces meet strict chemical emissions limits.

9to5 Seating products contribute to healthier interior environments. Our products are manufactured using plastic, nylon, steel, aluminum and polypropylene components that are 100% recyclable; we offer fabrics made from 100% recycled content; and we also use suppliers that share an Earth-friendly philosophy. We're proud that our products are certified below chemical emissions limits for TVOC, formaldehyde, total aldehydes, individual VOCs, and 4-phenylcyclohexene. Environmental Data Sheets for all 9to5 Seating products can be found at our web site www.9to5seating.com. For more information about GREENGUARD programs, visit www.GREENGUARD.org.

At its core, a green building is a better-performing building. It uses fewer resources and offers a better place to work through improved energy and water efficiency, better air quality, and access to natural daylight. We have been awarded the LEED® NC Gold Certification for our newly constructed corporate headquarters and manufacturing facility. Visit <https://9to5seating.com/sustainability/> to learn more about our commitment to sustainability.

lifetime warranty

9to5 Seating products are manufactured with meticulous attention to detail to achieve a level of quality that is free from defects in material and workmanship. In an effort to stand behind this philosophy, 9to5 Seating warrants to the original purchaser of the product and from the original date of sale, the following:

For all series except @NCE, Logic Plus, Sophie, and chairs that include the Heavy Duty (HD) option in the Logic, Strata and Theory series, Lifetime Warranty to the original end user; the company will repair or replace, at its option, factory-defective structural and mechanical parts with comparable product, without charge. This warranty is for single-shift, standard commercial usage, defined as a standard eight-hour work day, five days a week. Weight limitations vary by product. For Sophie and Sophie Tables Series: 9to5 Seating warrants Sophie and Sophie tables for a period of twelve (12) years of multi-shift use to the original purchaser. The company will repair or replace at its option factory defective structural and mechanical parts with comparable product, without charge.

Upholstery fabric, mesh and foam are warranted against wear through and deterioration during normal usage for a period of five (5) years. However, the company does not warrant leather against routine scratching and scuffing, as all leather is subject to minor blemishes during use. COM and COL are not warranted. Due to natural variations in material, furniture containing leather is sold subject to normal variations and/or irregularities of color, texture, and grain.

For the @NCE Series:

9to5 Seating warrants the @NCE series of chairs for a period of five (5) years of single-shift use to the original purchaser; the company will repair or replace, at its option, factory-defective structural and mechanical parts with comparable product, without charge. This warranty is for single-shift, standard commercial usage, defined as a standard eight-hour work day, five days a week. Weight limitations vary by product.

For Logic Plus Large Occupant Series:

9to5 Seating warrants the Logic Plus Large Occupant chairs for a period of ten (10) years of single-shift use to the original purchaser; the company will repair or replace, at its option, factory-defective structural and mechanical parts with comparable product, without charge. This warranty is for single-shift applications with persons weighing less than 500 lbs.

For the chairs that include the Heavy Duty (HD) option in the Logic, Strata and Theory Series:

9to5 Seating warrants the aforementioned chairs for a period of ten (10) years of multi-shift use to the original purchaser; the company will repair or replace at its option factory defective structural and mechanical parts with comparable product, without charge. This warranty is for multi-shift applications with persons weighing less than 350 lbs.

Only upholstery fabrics with an abrasion resistance performance rating of 150,000 double rubs or more are warranted against wear-through and foam deterioration for a period of three (3) years of multiple-shift use.

Claim Process

Should parts fail for any model during normal use within the applicable warranty period, please fill out a Warranty Request Form on our website here: <https://9to5seating.com/warranty-request/>. Provide 9to5 Seating with a description of the failure and proof of purchase (Sales Order number located on the bottom of the chair). If requested by the company, the original purchaser must return the part or product with freight or other shipping charges prepaid, together with a copy of original sales receipt. Please do not send parts without prior authorization.

Send parts to:

9to5 Seating – Warranty Department
3211 Jack Northrop Avenue
Hawthorne, CA 90250

9to5 Seating will inspect the part in question, and repair or replace with a comparable product, at its option, any defective part at no charge to the original purchaser and return defective item thereafter. This warranty does not apply to product or parts of the product that have been subjected to misuse or abuse, accident, alteration, unauthorized repair, or damage in transit. You agree to indemnify and hold harmless 9to5 Seating, its officers, directors, shareholders, employees, and agents from any actions, claims, demands, damages, liabilities, costs, and strict liability in tort or contract, or any other legal theory arising out of the misuse or abuse, alteration, or damage in transit of the product. Under no circumstances will the company be liable for injuries or damages arising from the use of the product.

Limitation of Liability

Under no circumstance, including but not limited to breach of contract, breach of warranty, or negligence, shall 9to5 Seating be liable for lost profits, loss of goodwill, stored data, general, special, consequential or exemplary damages, even if 9to5 Seating had notice of these damages or they were foreseeable. 9to5 Seating shall not be responsible for verifying dealers' or customers' description of needs, data, or fitness for a particular purpose of goods. 9to5 Seating's liability in all cases shall be limited to repair or replacement of the defective parts with a comparable product. Should a comparable replacement not be available, 9to5 Seating maximum liability will be limited to the original purchase price of the product. Damages resulting from misuse, abuse, alteration, negligence, or accidents are not covered under this warranty.

9to5 Seating makes no warranty that any of its products are suitable for any particular purpose and makes no other warranties, express or implied, other than those set out here. As codes and standards vary from one

jurisdiction to another, references to compliance are solely for convenience and without any representation as to accuracy or suitability. Users must verify the suitability of such information or product for their specific application. In no event shall 9to5 Seating be liable in either tort or contract for any loss or direct, special, incidental, consequential, or exemplary damages.

EXCEPT AS OTHERWISE PROVIDED, 9to5 Seating MAKES NO OTHER WARRANTIES, EXPRESSED OR IMPLIED, INCLUDING BUT NOT LIMITED TO THE WARRANTIES OF MERCHANTABILITY AND FITNESS FOR A PARTICULAR PURPOSE.

Labor Reimbursement

For products ordered on or after July 1, 2017, 9to5 Seating will pay the pre-approved labor costs to repair or replace defective parts, up to 12 months from the date of shipment from 9to5 Seating, excluding the @NCE series. All payments for such preapproved labor costs will be in the form of a credit to an active company account.

ANSI/BIFMA

The Business and Institutional Furniture Manufacturer's Association (BIFMA) has developed tests that have been approved by the American National Standards Institute (ANSI) for determining the strength and durability of seating in its everyday use. This statement does not serve as a warranty or guarantee, however, 9to5 Seating products found within this price list generally meet or exceed applicable BIFMA and ANSI standards.

Warranty Exceptions

- Colorfastness or matching of colors, or textures occurring in leather, or other materials that naturally exhibit inherent color variations
- COM/COL textiles
- Damage of textiles from exposure to sunlight and UV rays
- Damage to textiles from the use of cleaners not specified for use in the fabric specifications
- Variation of texture and natural markings such as neck wrinkles, scratches, backbone marks and stretch marks in leather
- Dye transfers caused by external contaminants (including clothing and accessory dyes such as those used on denim jeans) may migrate to lighter colors. This phenomenon is increased by humidity and temperature and is irreversible.
- Color matching of textiles exactly to samples, swatches or prior purchases
- Minor variations of color in textiles
- Minor irregularities of color, surface, grain and texture

- Creasing and/or gathering of textiles during upholstery application process
- Product normal wear and tear, which is to be expected over the course of ownership, e.g., fabric, mesh and arm pads
- Damage caused by the carrier in-transit, which will be handled as separate terms and/or claims against the carrier.
- Damage can be defined as concealed or visible. Visible damage needs to be reported immediately. Concealed damage needs to be reported within seven (7) business days.
- Damage caused by delivery/installation contractors, which will be handled as claims against the designated company, e.g., knife cuts on the exterior surfaces of a chair resulting from opening packaging or removing plastic wraps
- Failures and damage which result from negligence, abuse, accident or misuse, e.g., arm pads repeatedly hitting a desk or table
- Damage caused by markings or staining; damage caused by sharp objects or imprinting from instruments
- Products exposed to extreme hot and cold temperatures or excessive dry environments
- Products that have been modified or altered and any attachments to the product
- Products or parts not used, maintained or installed in accordance with the Company's installation, maintenance and/or applicable guidelines
- Floor samples or display models
- Products purchased "as is" and/or secondhand
- Products sold by unauthorized dealers
- The warranty is limited to replacement or repair and does not cover cost of transportation, labor or installation.

9to5 Seating reserves the right to make changes in design and construction or discontinue products without prior notice. 9to5 Seating reserves the right to make changes to the lifetime warranty or price book.

Since textiles vary in weave, thickness and memory, some creasing and/or gathering may occur during the upholstery application process. Due to natural variations over which we have no control, all chairs are sold subject to minor irregularities of color, surface, grain, and texture. Textiles are sold subject to minor variations of color. Because leather is a natural product, variations of texture are common and should be expected. Leather will contain natural markings such as neck wrinkles, scratches, backbone marks and stretch marks. These distinctions give leather its unique characteristics and are considered to be part of the natural beauty of leather.

general information

Hours

Order Desk: Monday – Friday: 6:00 a.m. to 5:00 p.m. PST

Shipping & Receiving: 8:00 a.m. to 4:30 p.m. PST

Telephone: 888.925.SEAT (7328)

www.9to5Seating.com

Visit our new Chair Designer, on our website, to build custom chairs to your project specs.

Condition of Sale

Possession of this price book does not necessarily constitute authority to purchase.

Minimum Order Size*

- Free freight for all orders of five or more 9to5 Seating and @NCE chairs
- \$20 (net) per chair for all orders of four 9to5 Seating and @NCE chairs or less

Sophie Series Chairs*

- \$120 (net) for Sophie orders of three units or less (excluding tables and accessories).

*Minimum quantities for Sophie cannot be combined with other 9to5 Seating chair series

Residential Delivery

- \$10 (net) per chair for 9to5 Seating and @NCE chairs. From the Sophie collection, only the single guest and bariatric models can be delivered to residences (residential delivery fee is in addition to the minimum order size charge if applicable).

Payment

9to5 Seating accepts all major credit cards, company checks, cash, and terms payment for approved accounts. Credit card payments are subject to a 3% service charge. A \$35 fee will be charged for returned checks.

Terms

Standard terms are net 30 days from date of invoice. Please respect these terms in order to protect your competitive pricing. Credit terms may be changed or canceled at 9to5 Seating's discretion.

1. All new accounts are required to remit a 50% deposit of the initial order's total dollar value prior to the order entry and the balance must be paid at the time of pick up or release to common carrier. A line of credit may be established upon acceptance of satisfactory references and the completion and signing of credit application.

2. The customer will be liable for any cost incurred in attempting collection of past due amounts, including attorney fees, whether or not a lawsuit is filed. Past due accounts are subject to a 2% per month (24% per annum) late charge, or maximum amount permitted under local law, for each thirty days, or part thereof that the outstanding balance remains unpaid beyond the thirtieth day after invoice date. Withholding of payments, because of carrier damages, shortages or other disputes is illegal and subject to charges.

3. Orders delayed due to credit hold will be rescheduled for production once the order has been credit released. A new lead time will be given at that time. Please contact Customer Care to coordinate details.

Prices

All prices are suggested retail and are subject to change without notice. We make every effort to notify all customers of such changes. Prices in effect at the time of shipment will prevail. Please refer to our online price book for the latest changes including product drops and additions.

Order Acknowledgement

Unless there is a credit issue or you are otherwise contacted, an order acknowledgement will be emailed to you once the order is approved by our Planning department. The order acknowledgement will confirm quantities, items ordered, and prices effective at the time of the order acceptance (prices may vary from the published list). Be sure to read these acknowledgements and contact us immediately if incorrect.

Shipping

Complete and specific instructions for shipping should be given at the time an order is placed. Orders that do not have specific instructions will be routed by the best method of shipment in accordance with the judgement of our traffic department. Any changes to shipping instructions must be submitted to our office in writing. Standard shipments are made via common carrier unless otherwise requested by the customer. Special routing requests made by the customer or the consignee may result in additional charges. Standard deliveries are dock-to-dock and are scheduled to occur Monday through Friday between 8:00 a.m. to 4:30 p.m.

9to5 Seating reserves the right to charge the customer for non-standard customer delivery requirements that may include delivery appointments, drop shipments, inside deliveries, residential, limited access, or requests for trucks with lift gates. Additional charges may also be incurred for redeliveries or re-consignments if the initial delivery cannot be made for any reason. 9to5 Seating will not be held responsible for issues or costs to the customer arising from carrier transit delays or missed appointments. For information concerning these charges, please contact Sales Support.

Change of Delivery Address Charges

- \$25 (net) charge for change of delivery address for small parcel (via Fed-x)
- For change of address requests for all other shipment methods, contact Customer Care

Guaranteed Delivery and Delivery Appointment

Shipments are not guaranteed. Guaranteed service is available at an additional cost. Please contact Customer Care for more information. We will work to arrange a specific delivery time with the carrier. Service guarantees contracted with carrier are done solely at the request of the customer and 9to5 Seating in no way assumes responsibility financially or otherwise for any costs incurred by the customer as a result of a carrier's failure on a guaranteed shipment. In the event of a carrier's failure on a guaranteed shipment, the associated guaranteed service fee will be removed.

Expedited Freight

Expedited service is available at an additional cost. Please contact Customer Care for more information

Drop Shipments

9to5 Seating will not drop ship without prior approval; additional charges may apply. Please contact Customer Care for additional information.

condition of sale

Fee Schedule

LTL – ACCESSORIAL CHARGES – Standard deliveries are dock-to-dock during standard business hours.

Courtesy Call Before Delivery (CCBD): \$0

- This is NOT a delivery appointment (not guaranteed a call will happen but will be requested)
- BOL Instructions = "For Carrier Convenience ONLY, call John Smith at XXX-XXX-XXXX"
- This is not applicable to Fedex parcel shipments

Mandatory Call Before Delivery (MSBD): \$25

- BOL Instructions = "MUST CALL before delivery, John Smith at XXX-XXX-XXXX"
- Guaranteed Delivery: Contact shipping department for quote
- BOL Instructions: "GUARANTEED DELIVERY, MUST DELIVER ON XX/XX/XX, Must Call John Smith at XXX-XXX-XXXX"

Liftgate for Delivery: \$100

- BOL Instructions = "Lift Gate Required for Delivery"
- Inside Delivery: Contact shipping department for quote
- Minimum of \$60, Based on weight and number of units, therefore every request needs to be quoted by shipping department

Blanket wrap orders fee: \$450

Limited Access Delivery: \$125

- Everything other than a standard dock-to-dock business location delivery, such as hospitals, schools, universities, construction sites, military bases, hotels, resorts, government buildings, casinos, amusement parks, golf courses, airports, etc.
- Limited access locations where a dock is difficult to access with a 53-ft. trailer

Redelivery: \$100

- In the event that no one is available to receive a shipment and a redelivery is necessary

Drop Shipments Direct to Site: \$150 (Includes Delivery Appointment)

- If within standard business hours and dock-to-dock; if there is a wait time to off load, additional charges will be incurred

Product Design

9to5 Seating reserves the right to make alterations in design and construction or to discontinue products without prior notice.

Change Orders

Orders that have been scheduled for production may not be changed. All changes on customer orders previously acknowledged must be requested in writing and subject to approval. In the event a revision is accepted, change fees may apply.

Will Call

Will Call orders will be scheduled and manufactured based on Customer requested completion dates. Customers will receive a notification once the Will Call order is ready to be picked up. Customers will have five (5) business days to pick up the order. If the order is not picked up within this timeframe, 9to5 Seating will ship the order to an offsite storage facility and will invoice the Customer. The following storage fees will be invoiced to the Customer:

- 1- 50 chairs: \$25/day
- 51-100 chairs: \$50/day
- 101+ chairs: \$75/day

Please direct any questions about the new Will Call policy to your Customer Care Representative at sales@9to5seating.com or 888.925.3728.

Freight Damage or Shortage

Before accepting a shipment from the carrier, check the boxes for visible damages. If a shortage or damage occurs during transit, it should be noted on the freight bill of lading at the time of delivery, and a claim filed within seven days from receipt of product. If concealed damage is discovered after delivery, request inspection from the delivering carrier IMMEDIATELY and save all packing materials until inspection is made. Contact Customer Care as soon as possible to report damage or shortage.

For all Will Call orders, make sure to inspect merchandise thoroughly. 9to5 Seating will not be liable for any damage or shortage to merchandise after it has been signed for at our dock. 9to5 Seating will not be liable for any installation costs that result from freight damage.

Cancellations & Returns

Due to immediate production scheduling, orders that have entered any stage of production cannot be cancelled. All 9to5 Seating chairs are made-to-order, custom designed chairs and are not "off the shelf". Requests for cancellation are not accepted until confirmed by 9to5 Seating. Product may only be returned after receiving a Return Merchandise Authorization number from 9to5 Seating. Returns are subject to a restocking charge equivalent to 35% of the net order plus freight. Unauthorized returns will be refused.

Replacement Parts

When ordering a replacement part submit a warranty request through our website by navigating to the warranty page and selecting the Warranty Request Form. As a helpful tip, have your 9to5 Seating Sales Order number available and please reference your instructions sheet to properly identify the correct part for your 9to5 Seating product.

Replacement parts are shipped within 48 hours from time of request. 9to5 Seating does not reimburse for labor and installation costs related to warranty replacements. Replacement parts needed to repair freight damage can be granted only if the request is received within five business days of receipt of the merchandise.

dimensions

Outside Width (W)

Distance measured at widest edges of chair.

Outside Depth (D)

With the outside back of chair against wall, the distance from the wall to the front edge of seat.

Outside Height (H)

Distance from floor to highest point of back.

Seat Width (SW)

Distance measured at narrowest point of seat's side edges.

Seat Depth (SD)

Distance measured using the BIFMA CMD (Chair Measuring Device) from the most prominent point of the lumbar to the front edge of the seat

Seat Height (SH)

Distance measured using the BIFMA CMD (Chair Measuring Device) from the floor to the bottom of the device on the front edge of the seat. The CMD weighs 100 lbs.

Back Width (BW)

Distance measured at narrowest point of back's side edges.

Back Height (BH)

Distance measured from inside edge of rear seat to top edge of back.

Inside Arm Width

Distance between arms, typically measured from mid-point.

Arm Height

Measured from the floor to top edge of arm.

lead time

9to5 Seating intends to have all approved orders ready for shipment within the below lead times. However, there may be delays due to causes beyond our control. Orders received after noon PST will be considered as having been received the following day. Credit must be cleared before processing. 9to5 Seating is not responsible for late deliveries from freight carriers.

Lead Times

1 Day ExpressShip includes the @NCE series.

5 Business Days ExpressShip includes all series excluding Lilly, Jax, Ellie and Sophie and new products for the following fabric cards: 9to5 Seating Breeze, 9to5 Seating Signature, 9to5 Seating Vivid, Momentum Swift 2.0 and 9to5 Seating Highlands L3.

Please specify "5 Day ExpressShip" on a separate purchase order to ensure proper handling and delivery time. DO NOT COMBINE with any other purchase order. In the event that a purchase order is not marked, order will be scheduled per our standard lead time below.

Standard 10 Day Lead Time includes all series excluding Sophie and new products for the following textiles: 9to5 Seating's cards including Breeze, Nautilus, Signature, Highlands L3 and Vivid. Supplier cards including Momentum Swift 2.0 and Performance 3.0, Green Hides Sierra L4, Maharam M Series, Stinson Fresh Energy and Ultrafabrics Impress the Senses.

Standard 15 Day Lead Time includes all series, all fabrics for the Standard 10 Day Lead Time plus Green Hides L5 Lena and graded-in textiles.

Contact Customer Care at (888) 925-7328 for lead times on large orders.

order procedure

To Place an Order

1. Fax your order to: 866.925.SEAT
2. E-mail your order to: sales@9to5seating.com

Specify complete model number, frame or plastic color, fabric pattern and color, quantity, ship-to address, payment method, and purchase order number. In the event that an error is made in production of the chair, the hard copy of the purchase order will be used as the resolution document.

Order Acknowledgement

Unless there is a credit issue or you are otherwise contacted, an order acknowledgement will be sent once the order is released from our Purchasing department. It will be faxed or emailed to you to confirm

Model Number Structure

When ordering, please create model number in accordance with the nomenclature below. Refer to Creating Series Model Number in the top right hand corner of specific model's price book page.

For orders that include a textile selection, please specify the names of the fabric manufacturer, the pattern, and the colorway. For example: Knoll Textiles Retreat Oasis

Bella

MODEL NUMBER CONTROL ARMS FRAME COLOR UPHOLSTERY MESH COLOR PLASTIC COLOR CASTERS PACKAGING OPTIONS
 1 3 - G T - A - F - A P - M - P - C 5 - - - -

* FOR ARMLESS CODE USE A00 * ONLY SELECT FOR MODELS 1360/1365 * ONLY SELECT CASTER CODE FOR MODELS 1315/1365

Lilly

MODEL NUMBER CONTROL BASE FINISH GRADE PACKAGING OPTIONS
 9 1 1 - L G - - - - -

Luna

MODEL NUMBER CONTROL ARMS PLASTIC COLOR MESH COLOR GRADE BASE CASTERS PACKAGING OPTIONS
 3 4 6 0 - - A 4 - P - M - - - B A - C - - - -

* FOR ARMLESS CODE USE A00

Neo

MODEL NUMBER CONTROL PLASTIC COLOR MESH COLOR ARM GRADE BASE NUMBER CASTERS PACKAGING
 3 1 6 - - P - M - A - - - B A - C - - - -

quantities, items ordered, and prices effective at the time of the order acceptance (prices may vary from the published list). Be sure to read these acknowledgements and contact us immediately if incorrect.

Shipment Notification

Upon shipment of an order a shipment notification will be faxed or emailed with carrier information.

packaging codes

How to Specify

9to5 Seating offers several packaging methods for most models. Please note not all packaging codes are available for each model. Reference the price book page for the model in question to view the packaging methods available. All available packaging methods and their corresponding prices can be found at the top of the price book page.

After determining the appropriate packaging method, please add the packaging code to the model nomenclature of the model as it appears on your purchase order. Example: 1725-M1-A4-101-AB.

AB – Assembled in Bag for Will Call and Blanket Wrapped

The chair will be fully assembled and covered with a clear plastic bag for protection from dust. Chairs shipping via blanket wrap carrier will be produced with packing method "AB" as the chairs will be picked up at the dock fully assembled in the will call area.

PAC – Partially Assembled in Carton

The chair will be produced and packed partially assembled typically with seat and back separated, and arms and controls pre-assembled in a shipping carton. Specially designed spacers are used to position all chairs in the carton and to prevent freight damage.

BAC – Back Assembled in Carton

The chair will be fully assembled with exception of the base, gas lift and casters that are packed into a specially designed carton for this hardware. The chair may be removed, casters placed in the base, gas lift placed in the base and the remaining chair set on top of the cylinder. No tools are required.

AC – Assembled in Carton

The chair will be fully assembled and placed in a carton. This applies primarily to guest chairs that must ship fully assembled to accommodate chair design. Some guest chairs ship with multiple chairs in one carton.

upholstery selection

Fabrics

Choose from thousands of different fabrics, comprised of varying price grades offered through 9to5 Seating's fabric cards. If you still can't find what you are looking for, you may choose from any of the textiles offered by one of our textile partners. There are thousands of patterns and colors to choose from. To make this easy for you, we have graded-in their entire product lines. Please refer to our website's Materials section to access the graded-in fabrics PDF.

Please note that while we strive to accurately represent our fabric swatches online, variations in screen settings and lighting may cause colors to appear slightly different in person. We recommend referencing physical fabric samples or requesting fabric swatches before making your final decision.

Leather

9to5 Seating offers three grades of leather. All L3 and L4 are upholstered with leather on the seating surface and vinyl on the back and side boxing. L5 is an all-leather cover. 9to5 also has a COL (customer's own leather) program.

L3 is a glove-soft, top grain European hide, available in Black.

L4 is a glove-soft, top grain Italian cowhide leather.

L5 is a luxurious Italian full-grain, semi-aniline dye leather with a soft hand and smooth supple surface with even coloration throughout the entire hide.

Fabric Orientation

In order to offer optimal customization with our upholstery, customers must indicate a railroad orientation on a purchase order. Fabric manufacturers suggest within the specifications if a fabric pattern is recommended for railroad orientation. Refer to the graded-in PDF on the 9to5 Seating website with fabrics with a railroad orientation.

Railroad or horizontal orientation requires more fabric than vertical orientation. When railroad orientation is requested, the fabric grade will be increased by one grade to compensate for any additional fabric. Please indicate railroad orientation if this is desired on a purchase order. The order will be handled as a special, and the railroad orientation will be executed. Please contact your Customer Care Representative if you have questions about railroad orientation.

customer material program

COM = customer's own material
COL = customer's own leather

Ordering Instructions

Contact Customer Care for inquiries regarding COM/COL or follow the instructions below to assure the best results to produce your COM/COL order.

Complete 9to5 Seating COM/COL form (see opposite page or download from website) and send it to 9to5 Seating along with a fabric sample.

All COM/COL fabrics must be approved by 9to5 Seating and will not be scheduled for production until the entire yardage/square footage requirements have been received. Approval can be completed by 9to5 Seating in 72 hours. 9to5 Seating will not return any excess COM/COL material. After 60 days from when the order ships, any excess COM/COL material will be recycled.

For non-directional, plain, solid colors or non-patterned fabrics, please follow COM yardage requirements as specified under each individual model number in our price list. For fabrics which require special application or direction, please attach a sample of the COM fabric to our COM form.

Include all information and return to 9to5 Seating at address shown below. All COM textiles received at 9to5 Seating must be clearly marked with customer's name, purchase order number, 9to5 Seating sales order number (if available) and any special instructions for application of textile.

Send fabric to:

9to5 Seating
 Attn.: COM Fabric Receiving
 3211 Jack Northrop Ave.
 Hawthorne, CA 90250

Upon receipt of COM textile, a production date will be given to the order and you will receive an acknowledgement by fax or e-mail.

Notes

1. COM/COL EXCESS YARDAGE - 9to5 Seating is not responsible for yardage submitted to 9to5 Seating beyond the required amount. Excess COM/COL materials will be discarded at the discretion of 9to5 Seating unless otherwise instructed by the customer at the time of order placement. If a customer requires the COM/COL excess yardage returned, they must contact Sales Support before order placement to make return COM/COL arrangements. The customer will be responsible for all COM/COL return delivery charges.

2. The yardage figures shown throughout the price list are estimates only. Calculations are based on 54" wide material with no repeat and cut in the woven way cutting direction for a single chair. For specific yardage based on width of material, chair model, and quantity, please contact Sales Support.

3. For large quantity orders please contact Sales Support for more precise yardage requirement. Actual yardage requirement per chair often decreases with larger orders.

4. To calculate COM yardage, use the chart below as a guide and add appropriate amounts to the generic yardage requirements listed in the pricer.

FABRIC		2'-14"	15'-27"	28'-36"
WIDTH	GENERIC YARDAGE	REPEAT	REPEAT	REPEAT
54"		+20%	+30%	+40%

5. COL: Leather quality can vary depending on the size of the hides. Larger hides (50 to 60 sq. ft.) tend to be higher quality and yield. Smaller hides (40 to 50 sq. ft.) tend to have more quality issues that may cause smaller yields, requiring the need for additional hides to be ordered.

6. For all COL orders, 9to5 Seating cannot take responsibility for the need to order additional COL due to quality issues and related small material yields.

customer's own material/ leather form

All COM textiles received at 9to5 Seating must be clearly marked with customer's name, purchase order number, 9to5 Seating sales order number (if available) and any special instructions for application of textile. Send COM textiles to 9to5 Seating Attention: COM Department 3211 Jack Northrop Ave. Hawthorne, CA 90250. For pattern matching/alignment, please contact Customer Care 888-925-7328.

PDF - ONLINE FORM

DATE:	ACCOUNT NUMBER:
DEALER NAME:	PURCHASE ORDER NUMBER:
ADDRESS	CITY/ZIP CODE
9T05 ORDER NUMBER (IF AVAILABLE)	PHONE NUMBER
MODEL NUMBER	DEALER CONTACT
QUANTITY	TRACKING # (IF AVAILABLE)

TEXTILE INFORMATION

MILL	FABRIC NAME/NUMBER
FABRIC COLOR	TOTAL YARDAGE SHIPPED

APPLICATION

IS THERE A DESIRED TOP AND BOTTOM TO THE FABRIC?	IS THE FABRIC STRIPE OR TWO-COLOR PLAID?
YES NO	YES NO

CHECK APPROPRIATE BOX FOR YOUR CHOICE OF FABRIC DIRECTION

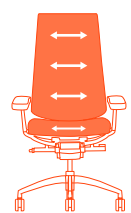
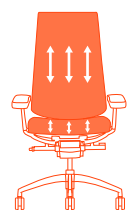
HORIZONTAL <input type="checkbox"/> 	TOP ATTACH SAMPLE TEXTILE HERE WITH DESIRED FACE AND DIRECTION DISPLAYED. IF THERE IS A PATTERN OR REPEAT, THE SAMPLE SHOULD BE LARGE ENOUGH TO SHOW ENTIRE REPEAT. BOTTOM
VERTICAL <input type="checkbox"/> 	

Upon receipt of COM textile, a production date will be given to the order and you will receive an acknowledgement by fax or e-mail. After 90 days from when the order ships, any excess COM/COL material will be recycled.

CAL TB 133 fire code

9to5 Seating's entire line of office seating meets California Technical Bulletin 117-2013 (CAL TB 117-2013) which has been in effect since January 1, 2015. This is a standard by which upholstered furniture has been tested for approval to meet a minimum fire standard. 9to5 Seating's standard product is not designed to meet California Technical Bulletin 133. However, upon special request, most 9to5 Seating products can be manufactured to meet the California Technical Bulletin 133 (CAL TB 133).

CAL TB 133

CAL TB 133 is the standard of furniture flammability required by the California Bureau of Home Furnishings and Thermal Insulation for furniture used in public buildings. New requirements proposed for furniture used in public buildings include: healthcare facilities, convalescent homes, public assembly areas of hotels and motels, hospitals, board and care homes, stadiums, licensed child care facilities, prisons and jails

CAL TB 133 Test

CAL TB 133 is a full-scale fire test for furniture manufactured for use in public buildings. The standards do not specify how to construct furniture, but only how it should perform when tested by the following procedures: A finished piece of furniture, never single components, is placed in a 10' x 12' x 8' chamber and is tested by applying a gas flame for 80 seconds. Then measurements are taken for the rate and amount of heat generated, temperature of the test room while furniture is burning, smoke capacity, amount of carbon monoxide generated and mass loss of the furniture for one hour or until the fire is completely extinguished.

A solution to pass this fire standard test is to sandwich a fire blocking liner between the foam and fabric of our chairs. This liner acts as a "fire extinguisher" by smothering the flame. As a response to CAL TB 133, and in order to meet customers' needs, 9to5 Seating has designed a variety of models and fabrics that can be combined to meet this new standard.

CAL 133 Models

The following models when combined with approved textiles and blocker meet the CAL 133 standard. All plastic models of Shuttle and Bella are also approved.

Acclaim: 2780

Agent: 1425, 1426, 1428, 1660, 1666, 1668

Bella: 1310, 1315, 1320, 1325, 1326, 1328, 1360, 1365, 1370, 1375, 1376, 1378

Bristol: 2360, 2366, 2368, 2380

Cosmo: 3220, 3230, 3250, 3260, 3250-GT

Cydia: 3300, 3300-GT, 3310, 3310-GT, 3306, 3308

Dash: 1130, 1131, 1134, 1135

Diddy: 2450, 2450-GT, 2450 R2

HÅG Capisco: 8106

Kelley: 1060, 1066, 1070, 1076

Link: 1410, 1415

Logic: 1725, 1726, 1728, 1760, 1766, 1768, 1780, 1790

Neo: 3160, 3166, 3168

Neo Lite: 3150, 3156, 3158

Shuttle: 1210, 1215, 1230, 1250, 1260, 1265, 1280

Sophie: 8102, 8103, 8104, 8111, 8112, 8113, 8118, 8119, 8122, 8123

Strata: 1545, 1546, 1548, 1555, 1560, 1580, 1560-GT, 1566, 1568, 1561, 1563

Vault: 1460, 1466, 1468, 1480

Zoom: 1115, 1125, 1126, 1128

COM CAL TB 133

COM compliance for CAL 133 models listed above can be determined by specifying upholstery with the exact characteristics as approved 9to5 Seating fabrics or by conducting a full chair burn test. The non-discountable test fee for each chair-fabric combination is \$500 net.

CAL TB 133 Upcharge

- 1 – 49 chairs: \$100 List upcharge per seat
- 50+ chairs: \$50 List upcharge per seat

To Order CAL TB 133

Clearly specify CAL TB 133 on order, choose your desired fabric, from options above, then add the indicated amount above to the standard list price. Standard lead times apply.

To Check Purchased Seating For CAL 133

To determine whether your current 9to5 Seating chair meets CAL TB 133, or to check an order you have recently received, check the bottom of the chair seat pan for the label shown below.

If your chair does not show this tag below, then your chair does NOT meet CAL TB 133.

NOTICE

This article is manufactured for use in public occupancies and meets the flammability requirements of California Bureau of Home Furnishings Technical Bulletin 133. Care should be exercised near open flame or with burning cigarettes.

two-tone options

Two-Tone Contrasting Textiles

When multiple textiles are selected on a single chair, clearly indicate your selection for both the seat or the back only on your purchase order. All fabric-upholstered chairs may be ordered with two-tone upholstery for no additional charge, except for the Koble, Lilly, Jax and Sophie series. **For Koble, Lilly, Jax, Ellie and Sophie, there is a \$100 list upcharge per item.** For two-tone with any chairs, if the two upholstery selections are of different grades, the chair will price at the higher of the two grades.

Available on these models:

Acclaim, Agent, Bella, Bristol, Clary, Core, Cortina, Cosmo, Dash, Ellie, HÅG Capisco, HÅG Celi, HÅG Tion, Jax, Lilly, Link, Logic, Shuttle, Sol, Sophie, Tori and Vox.



Ellie-Two Tone Option (Only Available for Ellie)

Reference for Lilly or Jax collections

custom embroidery form

Custom embroidery is a great way to display your company logo on upholstered chair backs. Embroidery can be done in multiple colors, shapes and sizes to suit your needs for a very reasonable cost and leadtime. To obtain a quote for embroidered upholstery, please fill out the adjacent form as completely as possible. You will need a graphic file, preferable in AI, EPS or other graphic format. Generally, higher resolution art (greater than 300 dpi) will be easier to work with. There will be a set-up charge to create a digitized file if you do not have one available. We will also need a PMS color number for each color thread required. 9to5 Seating is not responsible for poorly digitized files or graphic files from the requestor. If the logo is NOT to be in the back center; the location of the logo needs to be specified as an offset from the center of the back, vertically and horizontally. See form.

Keep in mind, embroidery is not a one-to-one replacement for printing, patches or heat transfer vinyl lettering. Embroidery thread is heavier, stronger and tighter density than the surrounding fabric and may pull or pucker on loosely woven fabric. Embroidery will always look best on strong, closely knit fabrics or vinyl. It is best to always get a sample for approval before placing the full production order.

All logos are trademarks of their respective owners. 9to5 Seating is not responsible for obtaining permission or use of copyrighted logos. Before you use, reproduce or distribute in any manner, you must first receive the express permission of the holder of the copyright or trademark of that logo. Failure to obtain such permission is a violation under international law.

Note: Dimensional tolerance of logo placement is $\pm 1/2$ " vertical and $\pm 1/4$ " horizontal.

PLEASE SEND A COMPLETED PHOTOCOPY OF THIS PAGE TO 9TO5 SEATING

FILLABLE FORMS LOCATED ON 9TOSSEATING.COM/DOWNLOADS

DATE:	ACCOUNT NUMBER:
DEALER NAME:	PURCHASE ORDER NUMBER:
DEALER CONTACT NAME:	CITY/ZIP CODE
PROJECT(END USER):	PHONE NUMBER
MODEL NUMBER	DEALER CONTACT
TOTAL PROJECT QUANTITY	TOTAL PROJECT NET:

COMMENTS:

IS THE EMBROIDERY FOR A BID?	IS A SAMPLE REQUIRED FOR CUSTOMER REVIEW PRIOR TO PRODUCTION OF ORDER?
YES NO	YES NO

IS A LOGO/GRAPHIC FILE AVAILABLE?	LOGO/GRAPHIC FILE TYPE?
YES NO	AI EPS PDF JPEG PNG OTHER:

STANDARD MODEL	QTY	HEIGHT	WIDTH	COLOR/PMS EQUIVALENT	TEXTILE MILL/PATTERN/COLOR

LOGO/IMAGE LOCATION (FROM LOGO CENTER TO CHAIR BACK CENTER)

VERTICAL OFFSET FROM CENTER:	HORIZONTAL OFFSET FROM CENTER:
INCHES	INCHES



TOP
ATTACH SAMPLE LOGO/GRAPHIC HERE.
BOTTOM

new for 2024

Available now

tori



UNPARALLELED PERFORMANCE WITH IMPACT

- Wraparound back design
- Mesh back or upholstered back models
- Mid-back or high-back options
- Seat slider and adjustable lumbar available

See pages 220-223



mila
black
frame



Available now

NEW KNIT BACK

- Add warmth and comfort to any space with Mila in knit back
- Available in a variety of colors

See pages 160-161

HÅG
tion



Available February 2024

HARMONIZING WORK AND WELLNESS

- Designed for flexibility and to fit in any workspace
- Multiple plastic and aluminum color options
- Made from 75% recycled and renewable materials
- GOOD DESIGN and Red Dot award winner

See pages 218-219

HÅG
celi



Available March 2024

SUSTAINABLE SEATING FOR DYNAMIC WORKSPACES

- Elegant chair for social and collaborative spaces
- Lightweight and comfortable
- Monochromatic plastic and aluminum color options
- Made with 75% recycled and renewable materials

acclaim

contemporary european styling yet subtle detailing

HIGH-BACK

GSA SIN # 33721

- Task, conference and executive seating
- Sleek rectilinear design with fine stitching
- Dual density foam provides firm profile with plush comfortable interior
- Polished arm with upholstered pad available
- Warranted to 300 lbs.



CREATING ACCLAIM MODEL NUMBER

MODEL NUMBER CONTROL ARMS GRADE BASE CASTERS PACKAGING OPTIONS

2 7 8 0 - [] [] - A [] [] - A [] [] - B A [] [] [] - C [] [] - [] [] [] - [] [] []

*FOR ARMLESS USE CODE A00 *IF BASE AND CASTER MODEL NUMBERS ARE LEFT BLANK THEN STANDARD OPTION WILL BE ASSUMED *GT MODELS DO NOT HAVE A CASTER CODE

PACKAGING NOTES

CODE	DESCRIPTION	LIST UPCHARGE
AB	ASSEMBLED IN BAG	\$0
PAC	PARTIALLY ASSEMBLED IN CARTON	\$0
BAC	BACK ASSEMBLED IN CARTON	\$80

MODEL	CONTROL	DESCRIPTION	ARM	FABRIC/LEATHER	FEATURES	DIMENSIONS	ARM OPTIONS	CASTER OPTIONS																																																																																						
2780	Y3	HIGH-BACK FULL SYNCHRO TILT	A00	<table border="1"> <thead> <tr> <th>A</th> <th>B/COM</th> <th>C</th> <th>D</th> <th>E</th> <th>F</th> <th>G</th> <th>L3/COL</th> <th>L4</th> <th>L5</th> </tr> </thead> <tbody> <tr><td>916</td><td>981</td><td>1036</td><td>1091</td><td>1194</td><td>1296</td><td>1386</td><td>1166</td><td>1216</td><td>1411</td></tr> <tr><td>A10</td><td>1026</td><td>1091</td><td>1146</td><td>1201</td><td>1304</td><td>1406</td><td>1276</td><td>1326</td><td>1521</td></tr> <tr><td>A19</td><td>1151</td><td>1216</td><td>1271</td><td>1326</td><td>1429</td><td>1531</td><td>1621</td><td>1401</td><td>1451</td><td>1646</td></tr> <tr><td>A23B/G</td><td>1011</td><td>1076</td><td>1131</td><td>1186</td><td>1289</td><td>1391</td><td>1481</td><td>1261</td><td>1311</td><td>1506</td></tr> <tr><td>A27</td><td>1151</td><td>1216</td><td>1271</td><td>1326</td><td>1429</td><td>1531</td><td>1621</td><td>1401</td><td>1451</td><td>1646</td></tr> <tr><td>A36</td><td>1041</td><td>1106</td><td>1161</td><td>1216</td><td>1319</td><td>1421</td><td>1511</td><td>1291</td><td>1341</td><td>1536</td></tr> <tr><td>A37</td><td>1056</td><td>1121</td><td>1176</td><td>1231</td><td>1334</td><td>1436</td><td>1526</td><td>1306</td><td>1356</td><td>1551</td></tr> </tbody> </table>	A	B/COM	C	D	E	F	G	L3/COL	L4	L5	916	981	1036	1091	1194	1296	1386	1166	1216	1411	A10	1026	1091	1146	1201	1304	1406	1276	1326	1521	A19	1151	1216	1271	1326	1429	1531	1621	1401	1451	1646	A23B/G	1011	1076	1131	1186	1289	1391	1481	1261	1311	1506	A27	1151	1216	1271	1326	1429	1531	1621	1401	1451	1646	A36	1041	1106	1161	1216	1319	1421	1511	1291	1341	1536	A37	1056	1121	1176	1231	1334	1436	1526	1306	1356	1551	<ul style="list-style-type: none"> • 3-position tilt lock • 2:1 back-to-seat tilt ratio • Center knob tension adjustment • 360° swivel • Pneumatic cylinder height adjustment 	WIDTH: 27.5 DEPTH: 26.5 HEIGHT: 44.0-48.5 SEAT WIDTH: 20.0 SEAT DEPTH: 17.0 SEAT HEIGHT: 18.0-23.0 SEAT HEIGHT W/ SEAT SLIDER: 19.0-24.0 BACK WIDTH: 21.5 BACK HEIGHT: 26.5 COM: 1.9 YD COL: 39.0 SQ FT WEIGHT: 48.0 LB	A10 \$110 Soft Touch C-Shaped Arm	A19 \$235 Polished Aluminum C-Shape Arm	C6 STD Large Diameter Carpet Casters
A	B/COM		C	D	E	F	G	L3/COL	L4	L5																																																																																				
916	981		1036	1091	1194	1296	1386	1166	1216	1411																																																																																				
A10	1026		1091	1146	1201	1304	1406	1276	1326	1521																																																																																				
A19	1151		1216	1271	1326	1429	1531	1621	1401	1451	1646																																																																																			
A23B/G	1011		1076	1131	1186	1289	1391	1481	1261	1311	1506																																																																																			
A27	1151		1216	1271	1326	1429	1531	1621	1401	1451	1646																																																																																			
A36	1041	1106	1161	1216	1319	1421	1511	1291	1341	1536																																																																																				
A37	1056	1121	1176	1231	1334	1436	1526	1306	1356	1551																																																																																				
2780	Y2	HIGH-BACK HEAVY DUTY SYNCHRO TILT	A00	<table border="1"> <thead> <tr> <th>A</th> <th>B/COM</th> <th>C</th> <th>D</th> <th>E</th> <th>F</th> <th>G</th> <th>L3/COL</th> <th>L4</th> <th>L5</th> </tr> </thead> <tbody> <tr><td>946</td><td>1011</td><td>1066</td><td>1121</td><td>1224</td><td>1326</td><td>1416</td><td>1196</td><td>1246</td><td>1441</td></tr> <tr><td>A10</td><td>1056</td><td>1121</td><td>1176</td><td>1231</td><td>1334</td><td>1436</td><td>1306</td><td>1356</td><td>1551</td></tr> <tr><td>A19</td><td>1181</td><td>1246</td><td>1301</td><td>1356</td><td>1459</td><td>1561</td><td>1431</td><td>1481</td><td>1676</td></tr> <tr><td>A23B/G</td><td>1041</td><td>1106</td><td>1161</td><td>1216</td><td>1319</td><td>1421</td><td>1511</td><td>1291</td><td>1341</td><td>1536</td></tr> <tr><td>A27</td><td>1181</td><td>1246</td><td>1301</td><td>1356</td><td>1459</td><td>1561</td><td>1431</td><td>1481</td><td>1676</td></tr> <tr><td>A36</td><td>1071</td><td>1136</td><td>1191</td><td>1246</td><td>1349</td><td>1451</td><td>1541</td><td>1321</td><td>1371</td><td>1566</td></tr> <tr><td>A37</td><td>1086</td><td>1151</td><td>1206</td><td>1261</td><td>1364</td><td>1466</td><td>1556</td><td>1336</td><td>1386</td><td>1581</td></tr> </tbody> </table>	A	B/COM	C	D	E	F	G	L3/COL	L4	L5	946	1011	1066	1121	1224	1326	1416	1196	1246	1441	A10	1056	1121	1176	1231	1334	1436	1306	1356	1551	A19	1181	1246	1301	1356	1459	1561	1431	1481	1676	A23B/G	1041	1106	1161	1216	1319	1421	1511	1291	1341	1536	A27	1181	1246	1301	1356	1459	1561	1431	1481	1676	A36	1071	1136	1191	1246	1349	1451	1541	1321	1371	1566	A37	1086	1151	1206	1261	1364	1466	1556	1336	1386	1581	<ul style="list-style-type: none"> • 4-position tilt lock • Side knob tension adjustment • 2:1 back-to-seat tilt ratio • 360° swivel • Pneumatic cylinder height adjustment 	WIDTH: 27.5 DEPTH: 26.5 HEIGHT: 44.0-49.0 SEAT WIDTH: 20.0 SEAT DEPTH: 17.0 SEAT HEIGHT: 18.0-23.0 SEAT HEIGHT W/ SEAT SLIDER: 19.0-24.0 BACK WIDTH: 21.5 BACK HEIGHT: 26.5 COM: 1.9 YD COL: 39.0 SQ FT WEIGHT: 44.0 LB	A23B/D \$95 6-Way Height Adjustable Arm w/ Sliding Pad - Black/ Dove Gray	A27 \$235 Polished Aluminum C-Shape Arm with Matching Upholstered Pad	C6S \$35 Large Diameter Hard Floor and Carpet Casters		
A	B/COM		C	D	E	F	G	L3/COL	L4	L5																																																																																				
946	1011		1066	1121	1224	1326	1416	1196	1246	1441																																																																																				
A10	1056		1121	1176	1231	1334	1436	1306	1356	1551																																																																																				
A19	1181		1246	1301	1356	1459	1561	1431	1481	1676																																																																																				
A23B/G	1041		1106	1161	1216	1319	1421	1511	1291	1341	1536																																																																																			
A27	1181		1246	1301	1356	1459	1561	1431	1481	1676																																																																																				
A36	1071	1136	1191	1246	1349	1451	1541	1321	1371	1566																																																																																				
A37	1086	1151	1206	1261	1364	1466	1556	1336	1386	1581																																																																																				
2780	W2	HIGH-BACK WEIGHT BALANCED SYNCHRO TILT	A00	<table border="1"> <thead> <tr> <th>A</th> <th>B/COM</th> <th>C</th> <th>D</th> <th>E</th> <th>F</th> <th>G</th> <th>L3/COL</th> <th>L4</th> <th>L5</th> </tr> </thead> <tbody> <tr><td>961</td><td>1026</td><td>1081</td><td>1136</td><td>1239</td><td>1341</td><td>1431</td><td>1211</td><td>1261</td><td>1456</td></tr> <tr><td>A10</td><td>1071</td><td>1136</td><td>1191</td><td>1246</td><td>1349</td><td>1451</td><td>1321</td><td>1371</td><td>1566</td></tr> <tr><td>A19</td><td>1196</td><td>1261</td><td>1316</td><td>1371</td><td>1474</td><td>1576</td><td>1446</td><td>1496</td><td>1691</td></tr> <tr><td>A23B/G</td><td>1056</td><td>1121</td><td>1176</td><td>1231</td><td>1334</td><td>1436</td><td>1526</td><td>1306</td><td>1356</td><td>1551</td></tr> <tr><td>A27</td><td>1196</td><td>1261</td><td>1316</td><td>1371</td><td>1474</td><td>1576</td><td>1446</td><td>1496</td><td>1691</td></tr> <tr><td>A36</td><td>1086</td><td>1151</td><td>1206</td><td>1261</td><td>1364</td><td>1466</td><td>1556</td><td>1336</td><td>1386</td><td>1581</td></tr> <tr><td>A37</td><td>1101</td><td>1166</td><td>1221</td><td>1276</td><td>1379</td><td>1481</td><td>1571</td><td>1351</td><td>1401</td><td>1596</td></tr> </tbody> </table>	A	B/COM	C	D	E	F	G	L3/COL	L4	L5	961	1026	1081	1136	1239	1341	1431	1211	1261	1456	A10	1071	1136	1191	1246	1349	1451	1321	1371	1566	A19	1196	1261	1316	1371	1474	1576	1446	1496	1691	A23B/G	1056	1121	1176	1231	1334	1436	1526	1306	1356	1551	A27	1196	1261	1316	1371	1474	1576	1446	1496	1691	A36	1086	1151	1206	1261	1364	1466	1556	1336	1386	1581	A37	1101	1166	1221	1276	1379	1481	1571	1351	1401	1596	<ul style="list-style-type: none"> • Automatic tension adjustment with option to modify • Tilt-limiter 4-position lock • 3:1 back-to-seat tilt ratio • 360° swivel • Pneumatic cylinder height adjustment 	WIDTH: 27.5 DEPTH: 26.5 HEIGHT: 44.0-48.5 SEAT WIDTH: 20.0 SEAT DEPTH: 17.0 SEAT HEIGHT: 18.0-22.5 BACK WIDTH: 21.5 BACK HEIGHT: 26.5 COM: 1.9 YD COL: 39.0 SQ FT WEIGHT: 44.0 LB	BA11B/G STD 27" Mid-Profile Nylon Base BA11B - Black BA11D - Graphite	BA12B/P \$110 27" Mid-Profile Aluminum Base BA12B - Black Powder Coat BA12P - Polished (C7 Chrome-Accented Casters Standard with Polished Base)			
A	B/COM		C	D	E	F	G	L3/COL	L4	L5																																																																																				
961	1026		1081	1136	1239	1341	1431	1211	1261	1456																																																																																				
A10	1071		1136	1191	1246	1349	1451	1321	1371	1566																																																																																				
A19	1196		1261	1316	1371	1474	1576	1446	1496	1691																																																																																				
A23B/G	1056		1121	1176	1231	1334	1436	1526	1306	1356	1551																																																																																			
A27	1196		1261	1316	1371	1474	1576	1446	1496	1691																																																																																				
A36	1086	1151	1206	1261	1364	1466	1556	1336	1386	1581																																																																																				
A37	1101	1166	1221	1276	1379	1481	1571	1351	1401	1596																																																																																				
							SS \$60 Seat Slider 2.5" Side Paddle Activated (for Models with Y2 and Y3 Controls Only)																																																																																							

agent

lending comfort, durability, and value to every project

LOW-BACK

GSA SIN # 33721

- Task, conference and stool seating
- Ratchet back lumbar height adjustment on select models
- Poly outer back
- Low- or mid-back models
- Warranted to 300 lbs.





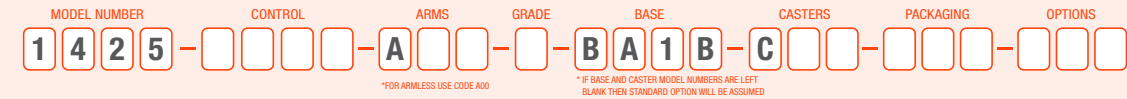









CREATING AGENT MODEL NUMBER



PACKAGING NOTES

CODE	DESCRIPTION	LIST UPCHARGE
AB	ASSEMBLED IN BAG	\$0
PAC	PARTIALLY ASSEMBLED IN CARTON	\$0
BAC	BACK ASSEMBLED IN CARTON	\$80

MODEL	CONTROL	DESCRIPTION	ARM	FABRIC										FEATURES	DIMENSIONS	ARM OPTIONS	CASTER OPTIONS	BASE OPTIONS	ADDITIONAL OPTIONS
				A	B/COM	C	D	E	F	G	L4	L5							
1425	B2	LOW-BACK BASIC TASK	A00	462	492	522	562	612	667	737	872	952	<ul style="list-style-type: none"> • 360-degree swivel • Pneumatic seat height adjustment 	WIDTH: 27.0 DEPTH: 26.5 HEIGHT: 31.5-36.0 SEAT WIDTH: 19.5 SEAT DEPTH: 15.5 SEAT HEIGHT: 17.5-22.0 BACK WIDTH: 16.5 BACK HEIGHT: 16.5 COM: 0.8 YD WEIGHT: 33.0 LB	 A4 \$100  A5 \$115	 A6 \$160  A7 \$175	 C1 STD		
			A4	562	592	622	662	712	767	837	972	1052							
			A5	577	607	637	677	727	782	852	987	1067							
			A6	622	652	682	722	772	827	897	1032	1112							
			A7	637	667	697	737	787	842	912	1047	1127							
			A16	587	617	647	687	737	792	862	997	1077							
			A36	587	617	647	687	737	792	862	997	1077							
			A37	602	632	662	702	752	807	877	1012	1092							
				SEAT SLIDER (SS) - NOT AVAILABLE															
1425	S2	LOW-BACK SWIVEL TILT WITH BACK DEPTH ADJUSTMENT	A00	507	537	567	607	657	712	782	917	997	<ul style="list-style-type: none"> • Adjustable back depth • Upright lock • Center knob tension adjustment • 360° swivel • Pneumatic cylinder height adjustment 	WIDTH: 27.0 DEPTH: 26.5 HEIGHT: 31.5-36.0 SEAT WIDTH: 19.5 SEAT DEPTH: 15.5 SEAT HEIGHT: 17.5-22.0 SEAT HEIGHT W/ SEAT SLIDER: 18.5-23 BACK WIDTH: 16.5 BACK HEIGHT: 16.5 COM: 0.8 YD WEIGHT: 35.0 LB	 A16 \$125	 A36 \$125	 C1S \$35		
			A4	607	637	667	707	757	812	882	1017	1097							
			A5	622	652	682	722	772	827	897	1032	1112							
			A6	667	697	727	767	817	872	942	1077	1157							
			A7	682	712	742	782	832	887	957	1092	1172							
			A16	632	662	692	732	782	837	907	1042	1122							
			A36	632	662	692	732	782	837	907	1042	1122							
			A37	647	677	707	747	797	852	922	1057	1137							
				SEAT SLIDER (SS) - ADD \$60															
1425	P1	LOW-BACK POSTURE BACK	A00	547	577	607	647	697	752	822	957	1037	<ul style="list-style-type: none"> • Ratchet back lumbar adjustment • Infinite back angle adjustment with free float • 360° swivel • Pneumatic seat height adjustment 	WIDTH: 27.0 DEPTH: 26.5 HEIGHT: 31.5-39.0 SEAT WIDTH: 19.5 SEAT DEPTH: 15.5 SEAT HEIGHT: 17.5-22.0 SEAT HEIGHT W/ SEAT SLIDER: 18.5-23.0 BACK WIDTH: 16.5 BACK HEIGHT: 16.5-19.5 COM: 0.8 YD WEIGHT: 37.0 LB			 BA1B STD		
			A4	647	677	707	747	797	852	922	1057	1137							
			A5	662	692	722	762	812	867	937	1072	1152							
			A6	707	737	767	807	857	912	982	1117	1197							
			A7	722	752	782	822	872	927	997	1132	1212							
			A16	672	702	732	772	822	877	947	1082	1162							
			A36	672	702	732	772	822	877	947	1082	1162							
			A37	687	717	747	787	837	892	962	1097	1177							
				SEAT SLIDER (SS) - ADD \$60															
1425	R1	LOW-BACK ROCKING TILT	A00	557	587	617	657	707	762	832	967	1047	<ul style="list-style-type: none"> • Ratchet back lumbar adjustment • Infinite back angle adjustment • Infinite tilt lock • Center knob tension adjustment • 360° swivel • Pneumatic cylinder height adjustment 	WIDTH: 27.0 DEPTH: 26.5 HEIGHT: 31.5-36.0 SEAT WIDTH: 19.5 SEAT DEPTH: 15.5 SEAT HEIGHT: 17.5-22.0 SEAT HEIGHT W/ SEAT SLIDER: 18.5-23.0 BACK WIDTH: 16.5 BACK HEIGHT: 16.5-19.5 COM: 0.8 YD WEIGHT: 33.0 LB	 EF1 \$30	 MF1 \$50	 SS \$60		
			A4	657	687	717	757	807	862	932	1067	1147							
			A5	672	702	732	772	822	877	947	1082	1162							
			A6	717	747	777	817	867	922	992	1127	1207							
			A7	732	762	792	832	882	937	1007	1142	1222							
			A16	682	712	742	782	832	887	957	1092	1172							
			A36	682	712	742	782	832	887	957	1092	1172							
			A37	697	727	757	797	847	902	972	1107	1187							
				SEAT SLIDER (SS) - ADD \$60															

ADDITIONAL OPTIONS

EF1 \$30: 1" Extra Foam on Seat. If EF1 is selected, cannot use MF1 in addition.

MF1 \$50: 1" Visco Elastic Memory Foam on Seat. If MF1 is selected, cannot use EF1 in addition.

SS \$60: Seat Slider 2.5" Side Paddle Activated (Standard with Y2 Control)

BT \$15: Replace Knob with Bolt (for B2 or S2 Controls Only)

agent

lending comfort, durability, and value to every project

GSA SIN # 33721

- Task, conference and stool seating
- Ratchet back lumbar height adjustment on select models
- Poly outer back
- Low- or mid-back models
- Warranted to 300 lbs.



LOW-BACK

CREATING AGENT MODEL NUMBER

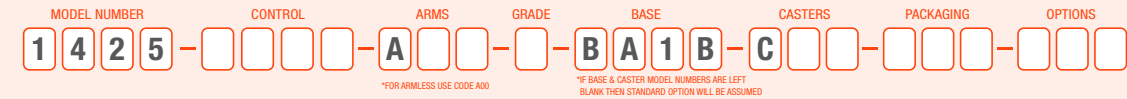

PACKAGING NOTES

CODE	DESCRIPTION	LIST UPCHARGE
AB	ASSEMBLED IN BAG	\$0
PAC	PARTIALLY ASSEMBLED IN CARTON	\$0
BAC	BACK ASSEMBLED IN CARTON	\$80

MODEL: 1425 CONTROL: M1

LOW-BACK MULTI-FUNCTION

ARM	FABRIC		A	B/COM	C	D	E	F	G	L4	L5
A00	607	637	667	707	757	812	882	1017	1097		
A4	707	737	767	807	857	912	982	1117	1197		
A5	722	752	782	822	872	927	997	1132	1212		
A6	767	797	827	867	917	972	1042	1177	1257		
A7	782	812	842	882	932	987	1057	1192	1272		
A16	732	762	792	832	882	937	1007	1142	1222		
A36	732	762	792	832	882	937	1007	1142	1222		
A37	747	777	807	847	897	952	1022	1157	1237		

SEAT SLIDER (SS) - ADD \$60

- FEATURES
- Ratchet back lumbar adjustment
 - Infinite back angle adjustment
 - 6° forward tilt
 - Center knob tension adjustment
 - 360° swivel
 - Pneumatic cylinder height adjustment

DIMENSIONS

WIDTH: 27.0
 DEPTH: 26.5
 HEIGHT: 31.5-36.0
 SEAT WIDTH: 19.5
 SEAT DEPTH: 15.5
 SEAT HEIGHT: 19.0-23.5
 SEAT HEIGHT W/ SEAT SLIDER: 20.0-24.5
 BACK WIDTH: 16.5
 BACK HEIGHT: 16.5-19.5
 COM: 0.8 YD
 WEIGHT: 43.0 LB

ARM OPTIONS

A4 \$100
 A5 \$115
 A6 \$160
 A7 \$175

A4 - Height Adjustable Arm
 A5 - Height/Width Adjustable Arm
 A6 - Height Adjustable Pivot Slide Arm
 A7 - Height/Width Adjustable Pivot Slide Arm

CASTER OPTIONS

C1 STD
 Carpet Casters

MODEL: 1425 CONTROL: Y2-SS

LOW-BACK HEAVY DUTY SYNCHRO TILT WITH SEAT SLIDER

ARM	FABRIC		A	B/COM	C	D	E	F	G	L4	L5
A00	647	677	707	747	797	852	922	1057	1137		
A4	747	777	807	847	897	952	1022	1157	1237		
A5	762	792	822	862	912	967	1037	1172	1252		
A6	807	837	867	907	957	1012	1082	1217	1297		
A7	822	852	882	922	972	1027	1097	1232	1312		
A16	772	802	832	872	922	977	1047	1182	1262		
A36	772	802	832	872	922	977	1047	1182	1262		
A37	787	817	847	887	937	992	1062	1197	1277		

SEAT SLIDER (SS) - STANDARD

- FEATURES
- Ratchet back lumbar adjustment
 - Seat slider included
 - 4-position tilt lock
 - Side knob tension control
 - 2:1 back-to-seat tilt ratio
 - 360° swivel
 - Pneumatic cylinder height adjustment

DIMENSIONS

WIDTH: 27.0
 DEPTH: 26.5
 HEIGHT: 31.5-36.0
 SEAT WIDTH: 19.5
 SEAT DEPTH: 15.5
 SEAT HEIGHT: 19.0-23.5
 BACK WIDTH: 16.5
 BACK HEIGHT: 16.5-19.5
 COM: 0.8 YD
 WEIGHT: 35.0 LB

ARM OPTIONS

A16 \$125
A36 \$125
A37 \$140

Soft Touch C-Shape Arm
 Height Adjustable Pivot/Slide Arm
 Height/Width Adjustable Pivot/Slide Arm

CASTER OPTIONS

C1S \$35
 Hard Floor and Carpet Casters

CASTER OPTIONS

C2S \$35
 Decompression Hard Floor and Soft Carpet Caster

BASE OPTIONS

BA1B STD
 26" Nylon Base - Black

ADDITIONAL OPTIONS

EF1 \$30
MF1 \$50
SS \$60

1" Extra Foam on Seat. If EF1 is selected, cannot use MF1 in addition.
 1" Visco Elastic Memory Foam on Seat. If MF1 is selected, cannot use EF1 in addition.
 Seat Slider 2.5" Side Paddle Activated (Standard with Y2 Control)

BT \$15
 Replace Knob with Bolt (for B2 or S2 Controls Only)

agent

lending comfort, durability, and value to every project

GSA SIN # 33721

- Task, conference and stool seating
- Ratchet back lumbar height adjustment on select models
- Poly outer back
- Low- or mid-back models
- Warranted to 300 lbs.



CREATING AGENT MODEL NUMBER



PACKAGING NOTES

CODE	DESCRIPTION	LIST UPCHARGE
AB	ASSEMBLED IN BAG	\$0
PAC	PARTIALLY ASSEMBLED IN CARTON	\$0
BAC	BACK ASSEMBLED IN CARTON	\$80

LOW-BACK STOOLS

MODEL	CONTROL	DESCRIPTION	ARM	FABRIC	A	B/COM	C	D	E	F	G	L4	L5
1426	B2	LOW-BACK 10" STOOL BASIC TASK WITH BACK DEPTH ADJUSTMENT Use for work surfaces up to 42" high	A00		587	617	647	687	737	792	862	997	1077
			A4		687	717	747	787	837	892	962	1097	1177
			A5		702	732	762	802	852	907	977	1112	1292
			A6		747	777	807	847	897	952	1022	1157	1452
			A7		762	792	822	862	912	967	1037	1172	1627
			A16		712	742	772	812	862	917	987	1122	1752
			A36		712	742	772	812	862	917	987	1122	1877
		A37		727	757	787	827	877	932	1002	1137	2017	

SEAT SLIDER (SS) - NOT AVAILABLE

- FEATURES**
- Height-adjustable 20" diameter foot ring
 - 360° swivel
 - Pneumatic cylinder height adjustment

DIMENSIONS

WIDTH: 27.0
 DEPTH: 26.5
 HEIGHT: 40.5-50.5
 SEAT WIDTH: 19.5
 SEAT DEPTH: 15.5
 SEAT HEIGHT: 26.5-36.5
 BACK WIDTH: 16.5
 BACK HEIGHT: 16.5
 COM: 0.8 YD
 WEIGHT: 38.0 LB

ARM OPTIONS

A4 \$100
A5 \$115
 A4 - Height Adjustable Arm
 A5 - Height/Width Adjustable Arm

A6 \$160
A7 \$175
 A6 - Height Adjustable Pivot Slide Arm
 A7 - Height/Width Adjustable Pivot Slide Arm

CASTER OPTIONS

C1 STD
 Carpet Casters

C1S \$35
 Hard Floor and Carpet Casters

C2S \$35
 Decompression Hard Floor and Soft Carpet Caster

MODEL	CONTROL	DESCRIPTION	ARM	FABRIC	A	B/COM	C	D	E	F	G	L4	L5
1426	P1	LOW-BACK 10" STOOL POSTURE BACK Use for work surfaces up to 42" high	A00		672	702	732	772	822	877	947	1082	1162
			A4		772	802	832	872	922	977	1047	1182	1652
			A5		787	817	847	887	937	992	1062	1197	1222
			A6		832	862	892	932	982	1037	1107	1242	1262
			A7		847	877	907	947	997	1052	1122	1257	1312
			A16		797	827	857	897	947	1002	1072	1207	1367
			A36		797	827	857	897	947	1002	1072	1207	1437
		A37		812	842	872	912	962	1017	1087	1222	1162	

SEAT SLIDER (SS) - NOT AVAILABLE

- FEATURES**
- Height-adjustable 20" diameter foot ring
 - Ratchet back lumbar adjustment
 - Infinite back angle adjustment with free float
 - 360° swivel
 - Pneumatic cylinder height adjustment

DIMENSIONS

WIDTH: 27.0
 DEPTH: 26.5
 HEIGHT: 40.5-53.5
 SEAT WIDTH: 19.5
 SEAT DEPTH: 15.5
 SEAT HEIGHT: 26.5-36.5
 BACK WIDTH: 16.5
 BACK HEIGHT: 16.5-19.5
 COM: 0.8 YD
 WEIGHT: 42.0 LB

A16 \$125
 Soft Touch C-Shape Arm

A36 \$125
 Height Adjustable Pivot/Slide Arm

A37 \$140
 Height/Width Adjustable Pivot/Slide Arm

MODEL	CONTROL	DESCRIPTION	ARM	FABRIC	A	B/COM	C	D	E	F	G	L4	L5
1428	B2	LOW-BACK 8" STOOL BASIC TASK WITH BACK DEPTH ADJUSTMENT Use for work surfaces up to 36" high	A00		587	617	647	687	737	792	862	997	1282
			A4		687	717	747	787	837	892	962	1097	1382
			A5		702	732	762	802	852	907	977	1112	1397
			A6		747	777	807	847	897	952	1022	1157	1442
			A7		762	792	822	862	912	967	1037	1172	1457
			A16		712	742	772	812	862	917	987	1122	1407
			A36		712	742	772	812	862	917	987	1122	1407
		A37		727	757	787	827	877	932	1002	1137	1422	

SEAT SLIDER (SS) - NOT AVAILABLE

- FEATURES**
- Height-adjustable 20" diameter foot ring
 - 360° swivel
 - Pneumatic cylinder height adjustment

DIMENSIONS

WIDTH: 27.0
 DEPTH: 26.5
 HEIGHT: 35.0-43.0
 SEAT WIDTH: 19.5
 SEAT DEPTH: 15.5
 SEAT HEIGHT: 21.5-29.5
 BACK WIDTH: 16.5
 BACK HEIGHT: 16.5
 COM: 0.8 YD
 WEIGHT: 37.0 LB

BASE OPTIONS

BA1B STD
 26" Nylon Base - Black

MODEL	CONTROL	DESCRIPTION	ARM	FABRIC	A	B/COM	C	D	E	F	G	L4	L5
1428	P1	LOW-BACK 8" STOOL POSTURE BACK Use for work surfaces up to 36" high	A00		672	702	732	772	822	877	947	1082	1162
			A4		772	802	832	872	922	977	1047	1182	1262
			A5		787	817	847	887	937	992	1062	1197	1277
			A6		832	862	892	932	982	1037	1107	1242	1322
			A7		847	877	907	947	997	1052	1122	1257	1337
			A16		797	827	857	897	947	1002	1072	1207	1287
			A36		797	827	857	897	947	1002	1072	1207	1287
		A37		812	842	872	912	962	1017	1087	1222	1302	

SEAT SLIDER (SS) - NOT AVAILABLE

- FEATURES**
- Height-adjustable 20" diameter foot ring
 - Ratchet back lumbar adjustment
 - Infinite back angle adjustment with free float
 - 360° swivel
 - Pneumatic cylinder height adjustment

DIMENSIONS

WIDTH: 27.0
 DEPTH: 26.5
 HEIGHT: 35.0-43.0
 SEAT WIDTH: 19.5
 SEAT DEPTH: 15.5
 SEAT HEIGHT: 21.5-29.5
 BACK WIDTH: 16.5
 BACK HEIGHT: 16.5-19.5
 COM: 0.8 YD
 WEIGHT: 41.0 LB

ADDITIONAL OPTIONS

EF1 \$30
 1" Extra Foam on Seat. If EF1 is selected, cannot use MF1 in addition.

MF1 \$50
 1" Visco Elastic Memory Foam on Seat. If MF1 is selected, cannot use EF1 in addition.

BT \$15
 Replace Knob with Bolt (for B2 or S2 Controls Only)

agent

lending comfort, durability, and value to every project

GSA SIN # 33721

- Task, conference and stool seating
- Ratchet back lumbar height adjustment on select models
- Poly outer back
- Low- or mid-back models
- Warranted to 300 lbs.













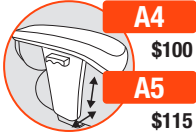

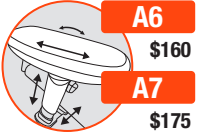













CREATING AGENT MODEL NUMBER



PACKAGING NOTES

CODE	DESCRIPTION	LIST UPCHARGE
AB	ASSEMBLED IN BAG	\$0
PAC	PARTIALLY ASSEMBLED IN CARTON	\$0
BAC	BACK ASSEMBLED IN CARTON	\$80

MID-BACK

MODEL	CONTROL	DESCRIPTION	ARM	FABRIC	FEATURES	DIMENSIONS	ARM OPTIONS	CASTER OPTIONS	
1660	B2	MID-BACK BASIC TASK WITH BACK DEPTH ADJUSTMENT	A00	A B/COM C D E F G	<ul style="list-style-type: none"> • 360° swivel • Pneumatic cylinder height adjustment 	WIDTH: 26.5 DEPTH: 26.5 HEIGHT: 40.0-44.5 SEAT WIDTH: 22.0 SEAT DEPTH: 17.0 SEAT HEIGHT: 18.5-23.0 BACK WIDTH: 19.5 BACK HEIGHT: 23.0-26.0 COM: 1.0 YD WEIGHT: 40.0 LB	 A4 \$100  A5 \$115  A6 \$160  A7 \$175	 C1 STD  C1S \$35  C2S \$35	
	A4		537 572 602 652 702 752 817						
	A5		637 672 702 752 802 852 917						
	A6		652 687 717 767 817 867 932						
	A7		697 732 762 812 862 912 977						
	A16		712 747 777 827 877 927 992						
	A36		662 697 727 777 827 877 942						
	A37		662 697 727 777 827 877 942						
1660	S2	MID-BACK SWIVEL TILT WITH BACK DEPTH ADJUSTMENT	A00	A B/COM C D E F G	<ul style="list-style-type: none"> • Adjustable back depth • Upright lock • Center knob tension adjustment • 360° swivel • Pneumatic cylinder height adjustment 	WIDTH: 26.5 DEPTH: 26.5 HEIGHT: 40.0-44.5 SEAT WIDTH: 22.0 SEAT DEPTH: 17.0 SEAT HEIGHT: 18.5-23.0 SEAT HEIGHT W/ SEAT SLIDER: 19.5-24.0 BACK WIDTH: 19.5 BACK HEIGHT: 23.0-26.0 COM: 1.0 YD WEIGHT: 42.0 LB	 A16 \$125  A36 \$125  A37 \$140  A90 \$235	 C1 STD  C1S \$35  C2S \$35	
	A4		582 617 647 697 747 797 862						
	A5		682 717 747 797 847 897 962						
	A6		697 732 762 812 862 912 977						
	A7		742 777 807 857 907 957 1022						
	A16		757 792 822 872 922 972 1037						
	A36		707 742 772 822 872 922 987						
	A37		707 742 772 822 872 922 987						
				SEAT SLIDER (SS) - ADD \$60					
1660	P1	MID-BACK POSTURE BACK	A00	A B/COM C D E F G	<ul style="list-style-type: none"> • Infinite back angle adjustment with free float • 360° swivel • Pneumatic cylinder height adjustment 	WIDTH: 26.5 DEPTH: 26.5 HEIGHT: 40.0-47.5 SEAT WIDTH: 22.0 SEAT DEPTH: 17.0 SEAT HEIGHT: 18.5-23.0 SEAT HEIGHT W/ SEAT SLIDER: 19.5-24.0 BACK WIDTH: 19.5 BACK HEIGHT: 23.0-26.0 COM: 1.0 YD WEIGHT: 44.0 LB	 A16 \$125  A36 \$125  A37 \$140  A90 \$235	 C1 STD  C1S \$35  C2S \$35	
	A4		622 657 687 737 787 837 902						
	A5		722 757 787 837 887 937 1002						
	A6		737 772 802 852 902 952 1017						
	A7		782 817 847 897 947 997 1062						
	A16		797 832 862 912 962 1012 1077						
	A36		747 782 812 862 912 962 1027						
	A37		747 782 812 862 912 962 1027						
				SEAT SLIDER (SS) - ADD \$60					
1660	R1	MID-BACK ROCKING TILT	A00	A B/COM C D E F G	<ul style="list-style-type: none"> • Infinite back angle adjustment • Infinite tilt lock • Center knob tension adjustment • 360° swivel • Pneumatic cylinder height adjustment 	WIDTH: 26.5 DEPTH: 26.5 HEIGHT: 40.0-47.5 SEAT WIDTH: 22.0 SEAT DEPTH: 16.0 SEAT HEIGHT: 18.5-23.0 SEAT HEIGHT W/ SEAT SLIDER: 19.5-24.0 BACK WIDTH: 19.5 BACK HEIGHT: 23.0-26.0 COM: 1.0 YD WEIGHT: 46.0 LB	 EF1 \$30  MF1 \$50  SS \$60	 BA1B STD  BT \$15	
	A4		632 667 697 747 797 847 912						
	A5		732 767 797 847 897 947 1012						
	A6		747 782 812 862 912 962 1027						
	A7		792 827 857 907 957 1007 1072						
	A16		807 842 872 922 972 1022 1087						
	A36		757 792 822 872 922 972 1037						
	A37		757 792 822 872 922 972 1037						
				SEAT SLIDER (SS) - ADD \$60					

agent

lending comfort, durability, and value to every project

MID-BACK

GSA SIN # 33721

- Task, conference and stool seating
- Ratchet back lumbar height adjustment on select models
- Poly outer back
- Low- or mid-back models
- Warranted to 300 lbs.



CREATING AGENT MODEL NUMBER

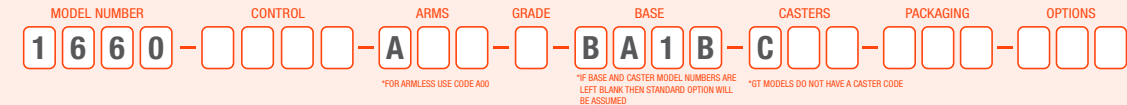

PACKAGING NOTES

CODE	DESCRIPTION	LIST UPCHARGE
AB	ASSEMBLED IN BAG	\$0
PAC	PARTIALLY ASSEMBLED IN CARTON	\$0
BAC	BACK ASSEMBLED IN CARTON	\$80

MODEL CONTROL DESCRIPTION

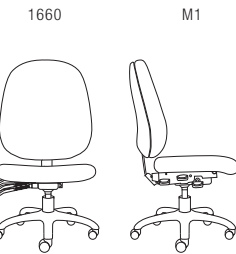

MID-BACK MULTI-FUNCTION

ARM

FABRIC

	A	B/COM	C	D	E	F	G
A00	682	717	747	797	847	897	962
A4	782	817	847	897	947	997	1062
A5	797	832	862	912	962	1012	1077
A6	842	877	907	957	1007	1057	1122
A7	857	892	922	972	1022	1072	1137
A16	807	842	872	922	972	1022	1087
A36	807	842	872	922	972	1022	1087
A37	822	857	887	937	987	1037	1102

SEAT SLIDER (SS) - ADD \$60

FEATURES

- Ratchet back lumbar adjustment
- Infinite back angle adjustment
- 6° forward tilt
- Center knob tension adjustment
- 360° swivel
- Pneumatic cylinder height adjustment

DIMENSIONS

WIDTH: 26.5
 DEPTH: 26.5
 HEIGHT: 38.5-44.0
 SEAT WIDTH: 22.0
 SEAT DEPTH: 17.5-20.5
 SEAT HEIGHT: 18.5-23.0
 SEAT HEIGHT W/ SEAT SLIDER: 19.5-24.0
 BACK WIDTH: 19.5
 BACK HEIGHT: 23.0-26.0
 COM: 1.0 YD
 WEIGHT: 48.0 LB

ARM OPTIONS



A4 - Height Adjustable Arm
 A5 - Height/Width Adjustable Arm



Soft Touch C-Shape Arm



Height/Width Adjustable Pivot/Slide Arm



A6 - Height Adjustable Pivot Slide Arm
 A7 - Height/Width Adjustable Pivot Slide Arm



Height Adjustable Pivot/Slide Arm



Height/Width Adjustable Breakaway Arm

CASTER OPTIONS



Carpet Casters



Hard Floor and Carpet Casters



Decompression Hard Floor and Soft Carpet Casters

BASE OPTIONS



26" Nylon Base - Black



MID-BACK HEAVY DUTY SYNCHRO TILT

ARM

FABRIC

	A	B/COM	C	D	E	F	G
A00	722	757	787	837	887	937	1002
A4	822	857	887	937	987	1037	1102
A5	837	872	902	952	1002	1052	1117
A6	882	917	947	997	1047	1097	1162
A7	897	932	962	1012	1062	1112	1177
A16	847	882	912	962	1012	1062	1127
A36	847	882	912	962	1012	1062	1127
A37	862	897	927	977	1027	1077	1142

SEAT SLIDER (SS) - STANDARD

FEATURES

- Ratchet back lumbar adjustment
- Seat slider standard
- 4-position tilt lock
- Side knob tension control
- 2:1 back-to-seat tilt ratio
- 360° swivel
- Pneumatic cylinder height adjustment

DIMENSIONS

WIDTH: 26.5
 DEPTH: 26.5
 HEIGHT: 38.5-44.0
 SEAT WIDTH: 22.0
 SEAT DEPTH: 17.5-20.5
 SEAT HEIGHT: 18.5-21.5
 BACK WIDTH: 19.5
 BACK HEIGHT: 23.0-26.0
 COM: 1.0 YD
 WEIGHT: 48.0 LB

ADDITIONAL OPTIONS



1" Extra Foam on Seat. If EF1 is selected, cannot use MF1 in addition.



Replace Knob with Bolt (for B2 or S2 Controls Only)



1" Visco Elastic Memory Foam on Seat. If MF1 is selected, cannot use EF1 in addition.



Seat Slider 2.5" Side Paddle Activated (Standard with Y2 Control)

agent

lending comfort, durability, and value to every project

GSA SIN # 33721

- Task, conference and stool seating
- Ratchet back lumbar height adjustment on select models
- Poly outer back
- Low- or mid-back models
- Warranted to 300 lbs.





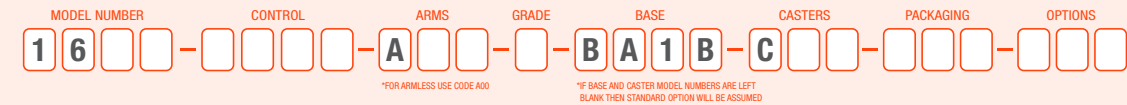







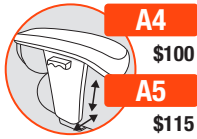

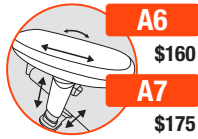





CREATING AGENT MODEL NUMBER



PACKAGING NOTES

CODE	DESCRIPTION	LIST UPCHARGE
AB	ASSEMBLED IN BAG	\$0
PAC	PARTIALLY ASSEMBLED IN CARTON	\$0
BAC	BACK ASSEMBLED IN CARTON	\$80

MID-BACK STOOLS

MODEL	CONTROL	DESCRIPTION	ARM	FABRIC	FEATURES	DIMENSIONS	ARM OPTIONS	CASTER OPTIONS
1666	B2	MID-BACK BASIC TASK WITH BACK DEPTH ADJUSTMENT Use for work surfaces up to 42" high	A00	A B/COM C D E F G	<ul style="list-style-type: none"> • Height-adjustable 20" diameter foot ring • Adjustable back depth • 360° swivel • Pneumatic cylinder height adjustment 	WIDTH: 26.5 DEPTH: 26.5 HEIGHT: 47.5-57.5 SEAT WIDTH: 22.0 SEAT DEPTH: 17.0 SEAT HEIGHT: 26.5-36.5 BACK WIDTH: 19.5 BACK HEIGHT: 23.0 COM: 1.0 YD WEIGHT: 46.0 LB	 A4 \$100  A5 \$115  A6 \$160  A7 \$175	 C1 STD  C1S \$35  C2S \$35
			A4	662 697 727 777 827 877 942				
			A5	762 797 827 877 927 977 1042				
			A6	777 812 842 892 942 992 1057				
			A7	822 857 887 937 987 1037 1102				
			A16	837 872 902 952 1002 1052 1117				
			A36	787 822 852 902 952 1002 1067				
			A37	787 822 852 902 952 1002 1067				
			A37	802 837 867 917 967 1017 1082				
			SEAT SLIDER (SS) - NOT AVAILABLE					
1666	P1	MID-BACK POSTURE BACK Use for work surfaces up to 42" high	A00	A B/COM C D E F G	<ul style="list-style-type: none"> • Height-adjustable 20" diameter foot ring • Ratchet back lumbar adjustment • Infinite back angle adjustment with free float • 360° swivel • Pneumatic cylinder height adjustment 	WIDTH: 26.5 DEPTH: 26.5 HEIGHT: 47.5-57.5 SEAT WIDTH: 22.0 SEAT DEPTH: 17.0 SEAT HEIGHT: 26.5-36.5 BACK WIDTH: 19.5 BACK HEIGHT: 23.0-26.0 COM: 1.0 YD WEIGHT: 50.0 LB	 A16 \$125  A36 \$125  A37 \$140  A90 \$235	 C1 STD  C1S \$35  C2S \$35
			A4	747 782 812 862 912 962 1027				
			A5	847 882 912 962 1012 1062 1127				
			A6	862 897 927 977 1027 1077 1142				
			A7	907 942 972 1022 1072 1122 1187				
			A16	922 957 987 1037 1087 1137 1202				
			A36	872 907 937 987 1037 1087 1152				
			A37	872 907 937 987 1037 1087 1152				
			A37	887 922 952 1002 1052 1102 1167				
			SEAT SLIDER (SS) - NOT AVAILABLE					
1668	B2	MID-BACK BASIC TASK WITH BACK DEPTH ADJUSTMENT Use for work surfaces up to 36" high	A00	A B/COM C D E F G	<ul style="list-style-type: none"> • Height-adjustable 20" diameter foot ring • Adjustable back depth • 360° swivel • Pneumatic cylinder height adjustment 	WIDTH: 26.5 DEPTH: 26.5 HEIGHT: 43.5-51.5 SEAT WIDTH: 22.0 SEAT DEPTH: 17.0 SEAT HEIGHT: 22.5-30.5 BACK WIDTH: 19.5 BACK HEIGHT: 23.0 COM: 1.0 YD WEIGHT: 45.0 LB	 BA1B STD	
			A4	662 697 727 777 827 877 942				
			A5	762 797 827 877 927 977 1042				
			A6	777 812 842 892 942 992 1057				
			A7	822 857 887 937 987 1037 1102				
			A16	837 872 902 952 1002 1052 1117				
			A36	787 822 852 902 952 1002 1067				
			A37	787 822 852 902 952 1002 1067				
			A37	802 837 867 917 967 1017 1082				
			SEAT SLIDER (SS) - NOT AVAILABLE					
1668	P1	MID-BACK POSTURE BACK Use for work surfaces up to 36" high	A00	A B/COM C D E F G	<ul style="list-style-type: none"> • Height-adjustable 20" diameter foot ring • Ratchet back lumbar adjustment • Infinite back angle adjustment with free float • 360° swivel • Pneumatic cylinder height adjustment 	WIDTH: 26.5 DEPTH: 26.5 HEIGHT: 43.5-55.0 SEAT WIDTH: 22.0 SEAT DEPTH: 17.0 SEAT HEIGHT: 22.5-30.5 BACK WIDTH: 19.5 BACK HEIGHT: 23.0-26.0 COM: 1.0 YD WEIGHT: 49.0 LB	 EF1 \$30  MF1 \$50  BT \$15	Replace Knob with Bolt (for B2 or S2 Controls Only)
			A4	747 782 812 862 912 962 1027				
			A5	847 882 912 962 1012 1062 1127				
			A6	862 897 927 977 1027 1077 1142				
			A7	907 942 972 1022 1072 1122 1187				
			A16	922 957 987 1037 1087 1137 1202				
			A36	872 907 937 987 1037 1087 1152				
			A37	872 907 937 987 1037 1087 1152				
			A37	887 922 952 1002 1052 1102 1167				
			SEAT SLIDER (SS) - NOT AVAILABLE					

bella

name your game, bella is ready to play

GSA SIN # 33721

- Multi-purpose seating, including stacking, nesting, task and task stool models
- Perfect for collaborative, meeting, training and break room spaces
- Plastic, upholstered or mesh back options
- Warranted to 300 lbs.



CREATING BELLA MODEL NUMBER

MODEL NUMBER	CONTROL	ARMS	FRAME COLOR	UPHOLSTERY	MESH COLOR	PLASTIC COLOR	CASTERS	PACKAGING
13	GT	A	F	M1	P	C5		

*FOR ARMLESS USE CODE A00 *ONLY SELECT FOR MODEL 1370

PACKAGING NOTES

CODE	DESCRIPTION	LIST UPCHARGE
AB	ASSEMBLED IN BAG	\$0
AC	ASSEMBLED IN CARTON	\$0

BELLA NESTING CHAIRS SHIP UP TO 2 PER CARTON

NESTING

MODEL	CONTROL	DESCRIPTION	ARM	PLASTIC	FEATURES	ARMLESS	W/ ARMS																																																																																																	
1320	GT	PLASTIC BACK & PLASTIC SEAT - AP Guest nesting	A00	P 410	<ul style="list-style-type: none"> • Flip-up seat for nesting and compact storage • Armless or armed 	WIDTH: 21.0 25.0 DEPTH: 26.0 26.0 HEIGHT: 33.0 33.0 SEAT WIDTH: 18.0 18.0 SEAT DEPTH: 16.0 16.0 SEAT HEIGHT: 18.0 18.0 BACK WIDTH: 19.0 19.0 BACK HEIGHT: 17.5 17.5 COM: N/A N/A WEIGHT: 19.0 LB 22.0 LB																																																																																																		
			A12	470				1370	GT	MESH BACK & PLASTIC SEAT - AP Guest nesting	A00	P 475	<ul style="list-style-type: none"> • Flip-up seat for nesting and compact storage • Armless or armed • Six mesh colors in black plastic 	WIDTH: 21.0 25.0 DEPTH: 26.0 26.0 HEIGHT: 33.0 33.0 SEAT WIDTH: 18.0 18.0 SEAT DEPTH: 16.0 16.0 SEAT HEIGHT: 18.0 18.0 BACK WIDTH: 19.0 19.0 BACK HEIGHT: 17.5 17.5 COM: N/A N/A WEIGHT: 19.0 LB 22.0 LB		A12	535	1320	GT	PLASTIC BACK & UPHOLSTERED SEAT - US Guest nesting	A00	<table border="1"> <thead> <tr> <th>A</th> <th>B/COM</th> <th>C</th> <th>D</th> <th>E</th> <th>F</th> <th>G</th> </tr> </thead> <tbody> <tr> <td>471</td> <td>496</td> <td>526</td> <td>566</td> <td>611</td> <td>661</td> <td>721</td> </tr> <tr> <td>531</td> <td>556</td> <td>586</td> <td>626</td> <td>671</td> <td>721</td> <td>781</td> </tr> </tbody> </table>	A	B/COM	C	D	E	F	G	471	496	526	566	611	661	721	531	556	586	626	671	721	781	<ul style="list-style-type: none"> • Flip-up seat for nesting and compact storage • Armless or armed 	WIDTH: 21.0 25.0 DEPTH: 26.0 26.0 HEIGHT: 33.0 33.0 SEAT WIDTH: 18.0 18.0 SEAT DEPTH: 16.0 16.0 SEAT HEIGHT: 18.5 18.5 BACK WIDTH: 19.0 19.0 BACK HEIGHT: 17.5 17.5 COM: 0.7 YD 0.7 YD WEIGHT: 21.0 LB 24.0 LB		A12		1370	GT	MESH BACK & UPHOLSTERED SEAT - US Guest nesting	A00	<table border="1"> <thead> <tr> <th>A</th> <th>B/COM</th> <th>C</th> <th>D</th> <th>E</th> <th>F</th> <th>G</th> </tr> </thead> <tbody> <tr> <td>536</td> <td>561</td> <td>591</td> <td>631</td> <td>676</td> <td>726</td> <td>786</td> </tr> <tr> <td>596</td> <td>621</td> <td>651</td> <td>691</td> <td>736</td> <td>786</td> <td>846</td> </tr> </tbody> </table>	A	B/COM	C	D	E	F	G	536	561	591	631	676	726	786	596	621	651	691	736	786	846	<ul style="list-style-type: none"> • Flip-up seat for nesting and compact storage • Armless or armed • Three mesh colors in black plastic 	WIDTH: 21.0 25.0 DEPTH: 26.0 26.0 HEIGHT: 33.0 33.0 SEAT WIDTH: 18.0 18.0 SEAT DEPTH: 16.0 16.0 SEAT HEIGHT: 18.5 18.5 BACK WIDTH: 19.0 19.0 BACK HEIGHT: 17.5 17.5 COM: 0.7 YD 0.7 YD WEIGHT: 21.0 LB 24.0 LB		A12		1320	GT	UPHOLSTERED BACK & UPHOLSTERED SEAT - UP Guest nesting	A00	<table border="1"> <thead> <tr> <th>A</th> <th>B/COM</th> <th>C</th> <th>D</th> <th>E</th> <th>F</th> <th>G</th> </tr> </thead> <tbody> <tr> <td>532</td> <td>562</td> <td>592</td> <td>647</td> <td>697</td> <td>742</td> <td>807</td> </tr> <tr> <td>592</td> <td>622</td> <td>652</td> <td>707</td> <td>757</td> <td>802</td> <td>867</td> </tr> </tbody> </table>	A	B/COM	C	D	E	F	G	532	562	592	647	697	742	807	592	622	652	707	757	802
1370	GT	MESH BACK & PLASTIC SEAT - AP Guest nesting	A00	P 475	<ul style="list-style-type: none"> • Flip-up seat for nesting and compact storage • Armless or armed • Six mesh colors in black plastic 	WIDTH: 21.0 25.0 DEPTH: 26.0 26.0 HEIGHT: 33.0 33.0 SEAT WIDTH: 18.0 18.0 SEAT DEPTH: 16.0 16.0 SEAT HEIGHT: 18.0 18.0 BACK WIDTH: 19.0 19.0 BACK HEIGHT: 17.5 17.5 COM: N/A N/A WEIGHT: 19.0 LB 22.0 LB																																																																																																		
			A12	535				1320	GT	PLASTIC BACK & UPHOLSTERED SEAT - US Guest nesting	A00	<table border="1"> <thead> <tr> <th>A</th> <th>B/COM</th> <th>C</th> <th>D</th> <th>E</th> <th>F</th> <th>G</th> </tr> </thead> <tbody> <tr> <td>471</td> <td>496</td> <td>526</td> <td>566</td> <td>611</td> <td>661</td> <td>721</td> </tr> <tr> <td>531</td> <td>556</td> <td>586</td> <td>626</td> <td>671</td> <td>721</td> <td>781</td> </tr> </tbody> </table>	A	B/COM	C	D	E	F	G	471	496	526	566	611	661	721	531	556	586	626	671	721	781	<ul style="list-style-type: none"> • Flip-up seat for nesting and compact storage • Armless or armed 	WIDTH: 21.0 25.0 DEPTH: 26.0 26.0 HEIGHT: 33.0 33.0 SEAT WIDTH: 18.0 18.0 SEAT DEPTH: 16.0 16.0 SEAT HEIGHT: 18.5 18.5 BACK WIDTH: 19.0 19.0 BACK HEIGHT: 17.5 17.5 COM: 0.7 YD 0.7 YD WEIGHT: 21.0 LB 24.0 LB		A12		1370	GT	MESH BACK & UPHOLSTERED SEAT - US Guest nesting	A00	<table border="1"> <thead> <tr> <th>A</th> <th>B/COM</th> <th>C</th> <th>D</th> <th>E</th> <th>F</th> <th>G</th> </tr> </thead> <tbody> <tr> <td>536</td> <td>561</td> <td>591</td> <td>631</td> <td>676</td> <td>726</td> <td>786</td> </tr> <tr> <td>596</td> <td>621</td> <td>651</td> <td>691</td> <td>736</td> <td>786</td> <td>846</td> </tr> </tbody> </table>	A	B/COM	C	D	E	F	G	536	561	591	631	676	726	786	596	621	651	691	736	786	846	<ul style="list-style-type: none"> • Flip-up seat for nesting and compact storage • Armless or armed • Three mesh colors in black plastic 	WIDTH: 21.0 25.0 DEPTH: 26.0 26.0 HEIGHT: 33.0 33.0 SEAT WIDTH: 18.0 18.0 SEAT DEPTH: 16.0 16.0 SEAT HEIGHT: 18.5 18.5 BACK WIDTH: 19.0 19.0 BACK HEIGHT: 17.5 17.5 COM: 0.7 YD 0.7 YD WEIGHT: 21.0 LB 24.0 LB		A12		1320	GT	UPHOLSTERED BACK & UPHOLSTERED SEAT - UP Guest nesting	A00	<table border="1"> <thead> <tr> <th>A</th> <th>B/COM</th> <th>C</th> <th>D</th> <th>E</th> <th>F</th> <th>G</th> </tr> </thead> <tbody> <tr> <td>532</td> <td>562</td> <td>592</td> <td>647</td> <td>697</td> <td>742</td> <td>807</td> </tr> <tr> <td>592</td> <td>622</td> <td>652</td> <td>707</td> <td>757</td> <td>802</td> <td>867</td> </tr> </tbody> </table>	A	B/COM	C	D	E	F	G	532	562	592	647	697	742	807	592	622	652	707	757	802	867	<ul style="list-style-type: none"> • Flip-up seat for nesting and compact storage • Armless or armed 	WIDTH: 21.0 25.0 DEPTH: 26.0 26.0 HEIGHT: 33.0 33.0 SEAT WIDTH: 18.0 18.0 SEAT DEPTH: 16.0 16.0 SEAT HEIGHT: 18.5 18.5 BACK WIDTH: 19.0 19.0 BACK HEIGHT: 17.5 17.5 COM: 0.7 YD 0.7 YD WEIGHT: 24.0 LB 27.0 LB		A12					
1320	GT	PLASTIC BACK & UPHOLSTERED SEAT - US Guest nesting	A00	<table border="1"> <thead> <tr> <th>A</th> <th>B/COM</th> <th>C</th> <th>D</th> <th>E</th> <th>F</th> <th>G</th> </tr> </thead> <tbody> <tr> <td>471</td> <td>496</td> <td>526</td> <td>566</td> <td>611</td> <td>661</td> <td>721</td> </tr> <tr> <td>531</td> <td>556</td> <td>586</td> <td>626</td> <td>671</td> <td>721</td> <td>781</td> </tr> </tbody> </table>	A	B/COM	C				D	E	F	G	471	496	526	566	611	661	721	531	556	586	626	671	721	781	<ul style="list-style-type: none"> • Flip-up seat for nesting and compact storage • Armless or armed 	WIDTH: 21.0 25.0 DEPTH: 26.0 26.0 HEIGHT: 33.0 33.0 SEAT WIDTH: 18.0 18.0 SEAT DEPTH: 16.0 16.0 SEAT HEIGHT: 18.5 18.5 BACK WIDTH: 19.0 19.0 BACK HEIGHT: 17.5 17.5 COM: 0.7 YD 0.7 YD WEIGHT: 21.0 LB 24.0 LB																																																																										
			A	B/COM	C	D	E	F	G																																																																																															
471	496	526	566	611	661	721																																																																																																		
531	556	586	626	671	721	781																																																																																																		
A12		1370	GT	MESH BACK & UPHOLSTERED SEAT - US Guest nesting	A00	<table border="1"> <thead> <tr> <th>A</th> <th>B/COM</th> <th>C</th> <th>D</th> <th>E</th> <th>F</th> <th>G</th> </tr> </thead> <tbody> <tr> <td>536</td> <td>561</td> <td>591</td> <td>631</td> <td>676</td> <td>726</td> <td>786</td> </tr> <tr> <td>596</td> <td>621</td> <td>651</td> <td>691</td> <td>736</td> <td>786</td> <td>846</td> </tr> </tbody> </table>	A	B/COM	C	D	E	F	G	536	561	591	631	676	726	786	596	621	651	691	736	786	846	<ul style="list-style-type: none"> • Flip-up seat for nesting and compact storage • Armless or armed • Three mesh colors in black plastic 	WIDTH: 21.0 25.0 DEPTH: 26.0 26.0 HEIGHT: 33.0 33.0 SEAT WIDTH: 18.0 18.0 SEAT DEPTH: 16.0 16.0 SEAT HEIGHT: 18.5 18.5 BACK WIDTH: 19.0 19.0 BACK HEIGHT: 17.5 17.5 COM: 0.7 YD 0.7 YD WEIGHT: 21.0 LB 24.0 LB		A12		1320	GT	UPHOLSTERED BACK & UPHOLSTERED SEAT - UP Guest nesting	A00	<table border="1"> <thead> <tr> <th>A</th> <th>B/COM</th> <th>C</th> <th>D</th> <th>E</th> <th>F</th> <th>G</th> </tr> </thead> <tbody> <tr> <td>532</td> <td>562</td> <td>592</td> <td>647</td> <td>697</td> <td>742</td> <td>807</td> </tr> <tr> <td>592</td> <td>622</td> <td>652</td> <td>707</td> <td>757</td> <td>802</td> <td>867</td> </tr> </tbody> </table>	A	B/COM	C	D	E	F	G	532	562	592	647	697	742	807	592	622	652	707	757	802	867	<ul style="list-style-type: none"> • Flip-up seat for nesting and compact storage • Armless or armed 	WIDTH: 21.0 25.0 DEPTH: 26.0 26.0 HEIGHT: 33.0 33.0 SEAT WIDTH: 18.0 18.0 SEAT DEPTH: 16.0 16.0 SEAT HEIGHT: 18.5 18.5 BACK WIDTH: 19.0 19.0 BACK HEIGHT: 17.5 17.5 COM: 0.7 YD 0.7 YD WEIGHT: 24.0 LB 27.0 LB		A12																																										
1370	GT				MESH BACK & UPHOLSTERED SEAT - US Guest nesting	A00	<table border="1"> <thead> <tr> <th>A</th> <th>B/COM</th> <th>C</th> <th>D</th> <th>E</th> <th>F</th> <th>G</th> </tr> </thead> <tbody> <tr> <td>536</td> <td>561</td> <td>591</td> <td>631</td> <td>676</td> <td>726</td> <td>786</td> </tr> <tr> <td>596</td> <td>621</td> <td>651</td> <td>691</td> <td>736</td> <td>786</td> <td>846</td> </tr> </tbody> </table>	A	B/COM	C	D	E	F	G	536	561	591	631	676	726	786	596	621	651	691	736	786				846	<ul style="list-style-type: none"> • Flip-up seat for nesting and compact storage • Armless or armed • Three mesh colors in black plastic 				WIDTH: 21.0 25.0 DEPTH: 26.0 26.0 HEIGHT: 33.0 33.0 SEAT WIDTH: 18.0 18.0 SEAT DEPTH: 16.0 16.0 SEAT HEIGHT: 18.5 18.5 BACK WIDTH: 19.0 19.0 BACK HEIGHT: 17.5 17.5 COM: 0.7 YD 0.7 YD WEIGHT: 21.0 LB 24.0 LB																																																																				
		A	B/COM	C		D	E	F	G																																																																																															
536	561	591	631	676	726	786																																																																																																		
596	621	651	691	736	786	846																																																																																																		
A12		1320	GT	UPHOLSTERED BACK & UPHOLSTERED SEAT - UP Guest nesting	A00	<table border="1"> <thead> <tr> <th>A</th> <th>B/COM</th> <th>C</th> <th>D</th> <th>E</th> <th>F</th> <th>G</th> </tr> </thead> <tbody> <tr> <td>532</td> <td>562</td> <td>592</td> <td>647</td> <td>697</td> <td>742</td> <td>807</td> </tr> <tr> <td>592</td> <td>622</td> <td>652</td> <td>707</td> <td>757</td> <td>802</td> <td>867</td> </tr> </tbody> </table>	A	B/COM	C	D	E	F	G	532	562	592	647	697	742	807	592	622	652	707	757	802	867	<ul style="list-style-type: none"> • Flip-up seat for nesting and compact storage • Armless or armed 	WIDTH: 21.0 25.0 DEPTH: 26.0 26.0 HEIGHT: 33.0 33.0 SEAT WIDTH: 18.0 18.0 SEAT DEPTH: 16.0 16.0 SEAT HEIGHT: 18.5 18.5 BACK WIDTH: 19.0 19.0 BACK HEIGHT: 17.5 17.5 COM: 0.7 YD 0.7 YD WEIGHT: 24.0 LB 27.0 LB		A12																																																																									
1320	GT				UPHOLSTERED BACK & UPHOLSTERED SEAT - UP Guest nesting	A00	<table border="1"> <thead> <tr> <th>A</th> <th>B/COM</th> <th>C</th> <th>D</th> <th>E</th> <th>F</th> <th>G</th> </tr> </thead> <tbody> <tr> <td>532</td> <td>562</td> <td>592</td> <td>647</td> <td>697</td> <td>742</td> <td>807</td> </tr> <tr> <td>592</td> <td>622</td> <td>652</td> <td>707</td> <td>757</td> <td>802</td> <td>867</td> </tr> </tbody> </table>	A	B/COM	C	D	E	F	G	532	562	592	647	697	742	807	592	622	652	707	757	802				867	<ul style="list-style-type: none"> • Flip-up seat for nesting and compact storage • Armless or armed 	WIDTH: 21.0 25.0 DEPTH: 26.0 26.0 HEIGHT: 33.0 33.0 SEAT WIDTH: 18.0 18.0 SEAT DEPTH: 16.0 16.0 SEAT HEIGHT: 18.5 18.5 BACK WIDTH: 19.0 19.0 BACK HEIGHT: 17.5 17.5 COM: 0.7 YD 0.7 YD WEIGHT: 24.0 LB 27.0 LB																																																																							
		A	B/COM	C		D	E	F	G																																																																																															
532	562	592	647	697	742	807																																																																																																		
592	622	652	707	757	802	867																																																																																																		
A12																																																																																																								

ARM OPTIONS

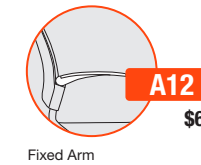

CASTER OPTIONS

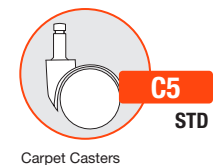

NESTING FOOTPRINT

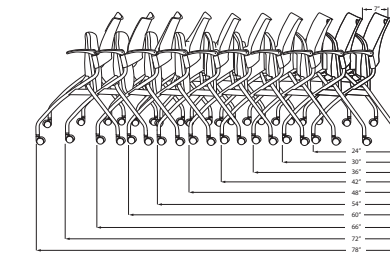

CAUTION: Careless nesting of chairs may scratch and damage frames

FRAME COLORS*

BLACK BF	SILVER SF
-------------	--------------

MESH COLORS

M1	BLACK M11	GRAY M12	SILVER M13	M1 MESH NC
-----------	--------------	-------------	---------------	----------------------

PLASTIC COLORS*

BLACK SWAN P01	WHITE WHISPER P05	FEDERAL BLUE P11	DOVE GRAY P14	CLOUD GRAY P15
LAGOON BLUE P16	APPLE GREEN P17	LATTE P19		

(BACK AND SEAT)

*Mesh back frame is P01 Black Swan.

bella

name your game, bella is ready to play

GSA SIN # 33721

- Multi-purpose seating, including stacking, nesting, task and task stool models
- Perfect for collaborative, meeting, training and break room spaces
- Plastic, upholstered or mesh back options
- Warranted to 300 lbs.



CREATING BELLA MODEL NUMBER

MODEL NUMBER CONTROL ARMS FRAME COLOR UPHOLSTERY MESH COLOR PLASTIC COLOR CASTERS PACKAGING OPTIONS

1 3 - GT - A - F - AP - M1 - P - C5 -

*FOR ARMLESS USE CODE A00 *ONLY SELECT FOR MODELS 1360/1365 *ONLY SELECT CASTER CODE FOR MODELS 1315/1365

PACKAGING NOTES

CODE	DESCRIPTION	LIST UPCHARGE
AB	ASSEMBLED IN BAG	\$0
AC	ASSEMBLED IN CARTON	\$0

BELLA STACK CHAIRS SHIP UP TO 3 PER CARTON

ALL PLASTIC - AP - GUEST

MODEL	CONTROL	DESCRIPTION	ARM	PLASTIC	FEATURES	ARMLESS	W/ ARMS
1310	GT	PLASTIC BACK & PLASTIC SEAT GUEST STACKING - AP	A00	P 345	<ul style="list-style-type: none"> • Stacks 4 high on the floor • Stacks 10 high on the optional stacking dolly • Black non-marring nylon glides 	WIDTH: 21.0	25.0
			A12	405		DEPTH: 26.0	26.0
			TAB-A00	480		HEIGHT: 33.0	33.0
			TAB-A12	520		SEAT WIDTH: 18.0	18.0
						SEAT DEPTH: 16.0	16.0
						SEAT HEIGHT: 18.0	18.0
						BACK WIDTH: 19.0	19.0
						BACK HEIGHT: 17.5	17.5
						COM: N/A	N/A
						WEIGHT: 13.0 LB	15.0 LB
1315	GT	PLASTIC BACK & PLASTIC SEAT GUEST STACKING WITH CASTERS - AP	A00	P 390	<ul style="list-style-type: none"> • Stacks 4 high on the floor • Stacks 10 high on the optional stacking dolly 	WIDTH: 21.0	25.0
			A12	450		DEPTH: 26.0	26.0
			TAB-A00	525		HEIGHT: 33.0	33.0
			TAB-A12	565		SEAT WIDTH: 18.0	18.0
						SEAT DEPTH: 16.0	16.0
						SEAT HEIGHT: 18.0	18.0
						BACK WIDTH: 19.0	19.0
						BACK HEIGHT: 17.5	17.5
						COM: N/A	N/A
						WEIGHT: 13.0 LB	15.0 LB
1360	GT	MESH BACK & PLASTIC SEAT GUEST STACKING - AP	A00	P 410	<ul style="list-style-type: none"> • Stacks 4 high on the floor • Stacks 10 high on the optional stacking dolly • Black non-marring nylon glides • Three mesh colors in black plastic 	WIDTH: 21.0	25.0
			A12	470		DEPTH: 26.0	26.0
			TAB-A00	545		HEIGHT: 33.0	33.0
			TAB-A12	585		SEAT WIDTH: 18.0	18.0
						SEAT DEPTH: 16.0	16.0
						SEAT HEIGHT: 18.0	18.0
						BACK WIDTH: 19.0	19.0
						BACK HEIGHT: 17.5	17.5
						COM: N/A	N/A
						WEIGHT: 13.0 LB	15.0 LB
1365	GT	MESH BACK & PLASTIC SEAT GUEST STACKING WITH CASTERS - AP	A00	P 455	<ul style="list-style-type: none"> • Stacks 4 high on the floor • Stacks 10 high on the optional stacking dolly • Three mesh colors in black plastic 	WIDTH: 21.0	25.0
			A12	515		DEPTH: 26.0	26.0
			TAB-A00	590		HEIGHT: 33.0	33.0
			TAB-A12	630		SEAT WIDTH: 18.0	18.0
						SEAT DEPTH: 16.0	16.0
						SEAT HEIGHT: 18.0	18.0
						BACK WIDTH: 19.0	19.0
						BACK HEIGHT: 17.5	17.5
						COM: N/A	N/A
						WEIGHT: 13.0 LB	15.0 LB

ARM OPTIONS

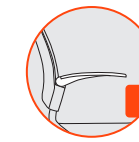

Fixed Arm

A12
\$60



TAB-A00
\$135

Right folding tablet with black supporting arm. Tablet is black. No left arm. Frame color BF/SF. Not Stackable with Tablet. Dimensions: 15.5" x 11.25" x 0.25"



TAB-A12
\$175

Right folding tablet with black supporting arm and A12 left arm. Tablet is black. Frame color BF/SF. Not Stackable with Tablet

CASTER OPTIONS

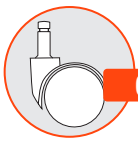

C5
STD

Carpet Casters

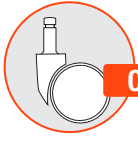

C5S
\$30

Hard Floor and Carpet Casters

ACCESSORIES



DL5
\$399

Stacking Dolly Stacks Chairs 10 High

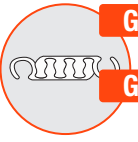

GC1
\$30

GC2
\$30

Ganging Clip - 2 per Set
GC1 - Armless-to-Armless
GC2 - Arm-to-Arm

FRAME COLORS*

BLACK BF	SILVER SF
-------------	--------------

MESH COLORS

M1	BLACK M11	GRAY M12	SILVER M13	M1 MESH NC
----	--------------	-------------	---------------	----------------------

PLASTIC COLORS*

BLACK SWAN P01	WHITE WHISPER P05	FEDERAL BLUE P11	DOVE GRAY P14	CLOUD GRAY P15
LAGOON BLUE P16	APPLE GREEN P17	LATTE P19		

(BACK AND SEAT)
*Mesh back frame is P01 Black Swan.

bella

name your game, bella is ready to play

GSA SIN # 33721

- Multi-purpose seating, including stacking, nesting, task and task stool models
- Perfect for collaborative, meeting, training and break room spaces
- Plastic, upholstered or mesh back options
- Warranted to 300 lbs.



CREATING BELLA MODEL NUMBER



PACKAGING NOTES

CODE	DESCRIPTION	LIST UPCHARGE
AB	ASSEMBLED IN BAG	\$0
AC	BACK ASSEMBLED IN CARTON	\$0

ALL PLASTIC - AP - TASK

MODEL	CONTROL	DESCRIPTION	ARM	PLASTIC	FEATURES	DIMENSIONS	ARM OPTIONS	CASTER OPTIONS
1325	B2	PLASTIC BACK & PLASTIC SEAT BASIC TASK	A00	P 470	<ul style="list-style-type: none"> • 360° swivel • Pneumatic cylinder height adjustment 	WIDTH: 26.0 DEPTH: 26.0 HEIGHT: 32.5-37.5 SEAT WIDTH: 18.0 SEAT DEPTH: 16.0 SEAT HEIGHT: 18.0-23.0 BACK WIDTH: 19.0 BACK HEIGHT: 17.5 COM: N/A WEIGHT: 24.5 LB	A12 \$60 Fixed Arm	C6 STD Carpet Casters C6S \$35 Hard Floor and Carpet Casters
	A12		530					
1325	S3	PLASTIC BACK & PLASTIC SEAT SWIVEL TILT	A00	P 505	<ul style="list-style-type: none"> • Upright lock • Center knob tension adjustment • 360° swivel • Pneumatic cylinder height adjustment 	WIDTH: 26.0 DEPTH: 26.0 HEIGHT: 33.0-37.5 SEAT WIDTH: 18.0 SEAT DEPTH: 16.0 SEAT HEIGHT: 17.0-21.5 BACK WIDTH: 19.0 BACK HEIGHT: 17.5 COM: N/A WEIGHT: 25.5 LB	BA11B STD 27" Mid-Profile Nylon Base BA11B - Black	BA12B/P/S \$110 27" Mid-Profile Aluminum Base BA12B - Black Powder Coat BA12P - Polished BA12S - Silver Powder Coat
	A12		565					
1375	B2	MESH BACK & PLASTIC SEAT BASIC TASK	A00	P 535	<ul style="list-style-type: none"> • 360° swivel • Pneumatic cylinder height adjustment • Three mesh colors in black plastic 	WIDTH: 26.0 DEPTH: 26.0 HEIGHT: 32.5-37.5 SEAT WIDTH: 18.0 SEAT DEPTH: 16.0 SEAT HEIGHT: 18.0-23.0 BACK WIDTH: 19.0 BACK HEIGHT: 17.5 COM: N/A WEIGHT: 24.5 LB	<div style="display: flex; justify-content: space-around;"> <div>BLACK BF</div> <div>SILVER SF</div> </div>	
	A12		595					
1375	S3	MESH BACK & PLASTIC SEAT SWIVEL TILT	A00	P 570	<ul style="list-style-type: none"> • Upright lock • Center knob tension adjustment • 360° swivel • Pneumatic cylinder height adjustment • Three mesh colors in black plastic 	WIDTH: 26.0 DEPTH: 26.0 HEIGHT: 33.0-37.5 SEAT WIDTH: 18.0 SEAT DEPTH: 16.0 SEAT HEIGHT: 17.0-21.5 BACK WIDTH: 19.0 BACK HEIGHT: 17.5 COM: N/A WEIGHT: 25.5 LB	<div style="display: flex; justify-content: space-around;"> <div>M1</div> <div>BLACK M11</div> <div>GRAY M12</div> <div>SILVER M13</div> </div>	M1 MESH NC
	A12		630					

FRAME COLORS

BLACK BF	SILVER SF
-------------	--------------

MESH COLORS

M1	BLACK M11	GRAY M12	SILVER M13	M1 MESH NC
-----------	--------------	-------------	---------------	----------------------

PLASTIC COLORS*

BLACK SWAN P01	WHITE WHISPER P05	FEDERAL BLUE P11	DOVE GRAY P14	CLOUD GRAY P15
LAGOON BLUE P16	APPLE GREEN P17	LATTE P19		

(BACK AND SEAT)
*Mesh back frame is P01 Black Swan.

bella

name your game, bella is ready to play

GSA SIN # 33721

- Multi-purpose seating, including stacking, nesting, task and task stool models
- Perfect for collaborative, meeting, training and break room spaces
- Plastic, upholstered or mesh back options
- Warranted to 300 lbs.



CREATING BELLA MODEL NUMBER



PACKAGING NOTES

CODE	DESCRIPTION	LIST UPCHARGE
AB	ASSEMBLED IN BAG	\$0
BAC	BACK ASSEMBLED IN CARTON	\$0

ALL PLASTIC - AP - STOOLS

MODEL	CONTROL	DESCRIPTION	ARM	PLASTIC	FEATURES	DIMENSIONS	ARM OPTIONS	CASTER OPTIONS
1326	B2	PLASTIC BACK & PLASTIC SEAT 10" STOOL Use for work surfaces up to 42" high	A00 A12	P 595 655	<ul style="list-style-type: none"> • 360° swivel • Pneumatic cylinder height adjustment 	WIDTH: 26.0 DEPTH: 26.0 HEIGHT: 40.0-50.0 SEAT WIDTH: 18.0 SEAT DEPTH: 16.0 SEAT HEIGHT: 25.5-35.5 BACK WIDTH: 19.0 BACK HEIGHT: 17.5 COM: N/A WEIGHT: 30.5 LB	A12 \$60 Fixed Arm	C6 STD Carpet Casters C6S \$35 Hard Floor and Carpet Casters
1328	B2	PLASTIC BACK & PLASTIC SEAT 8" STOOL Use for work surfaces up to 36" high	A00 A12	P 595 655	<ul style="list-style-type: none"> • 360° swivel • Pneumatic cylinder height adjustment 	WIDTH: 26.0 DEPTH: 26.0 HEIGHT: 36.0-44.0 SEAT WIDTH: 18.0 SEAT DEPTH: 16.0 SEAT HEIGHT: 21.5-29.5 BACK WIDTH: 19.0 BACK HEIGHT: 17.5 COM: N/A WEIGHT: 29.5 LB		
1376	B2	MESH BACK & PLASTIC SEAT 10" STOOL Use for work surfaces up to 42" high	A00 A12	P 660 720	<ul style="list-style-type: none"> • 360° swivel • Pneumatic cylinder height adjustment • Three mesh colors in black plastic 	WIDTH: 26.0 DEPTH: 26.0 HEIGHT: 40.0-50.0 SEAT WIDTH: 18.0 SEAT DEPTH: 16.0 SEAT HEIGHT: 25.5-35.5 BACK WIDTH: 19.0 BACK HEIGHT: 17.5 COM: N/A WEIGHT: 30.5 LB		
1378	B2	MESH BACK & PLASTIC SEAT 8" STOOL Use for work surfaces up to 36" high	A00 A12	P 660 720	<ul style="list-style-type: none"> • 360° swivel • Pneumatic cylinder height adjustment • Three mesh colors in black plastic 	WIDTH: 26.0 DEPTH: 26.0 HEIGHT: 36.0-44.0 SEAT WIDTH: 18.0 SEAT DEPTH: 16.0 SEAT HEIGHT: 21.5-29.5 BACK WIDTH: 19.0 BACK HEIGHT: 17.5 COM: N/A WEIGHT: 29.5 LB		

FRAME COLORS

BLACK BF	SILVER SF
-------------	--------------

MESH COLORS

M1	BLACK M11	GRAY M12	SILVER M13	M1 MESH NC
----	--------------	-------------	---------------	----------------------

PLASTIC COLORS*

BLACK SWAN P01	WHITE WHISPER P05	FEDERAL BLUE P11	DOVE GRAY P14	CLOUD GRAY P15
LAGOON BLUE P16	APPLE GREEN P17	LATTE P19		

(BACK AND SEAT)

*Mesh back frame is P01 Black Swan.

bella

name your game, bella is ready to play

GSA SIN # 33721

- Multi-purpose seating, including stacking, nesting, task and task stool models
- Perfect for collaborative, meeting, training and break room spaces
- Plastic, upholstered or mesh back options
- Warranted to 300 lbs.



CREATING BELLA MODEL NUMBER

MODEL NUMBER CONTROL ARMS FRAME COLOR UPHOLSTERY MESH COLOR GRADE PLASTIC COLOR CASTERS PACKAGING OPTIONS

1 3 - GT - A - F - U - S - M 1 - P - C 5







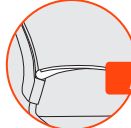

* FOR ARMLESS USE CODE ARM * ONLY SELECT FOR MODELS 1360/1365 * ONLY SELECT CASTER CODE FOR MODELS 1315/1365

PACKAGING NOTES

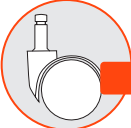
CODE	DESCRIPTION	LIST UPCHARGE
AB	ASSEMBLED IN BAG	\$0
AC	ASSEMBLED IN CARTON	\$0

BELLA STACK CHAIRS SHIP UP TO 3 PER CARTON

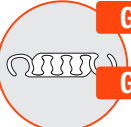
UPHOLSTERED SEAT - US - GUEST

MODEL	CONTROL	DESCRIPTION	ARM	FABRIC	FEATURES	ARMLESS	W/ ARMS	ARM OPTIONS	CASTER OPTIONS						
1310	GT	PLASTIC BACK & UPHOLSTERED SEAT GUEST STACKING - US	A00	A	B/COM	C	D	E	F	G	<ul style="list-style-type: none"> • Stacks 4 high on the floor • Stacks 10 high on the optional stacking dolly • Black non-marring nylon glides 	WIDTH: 21.0	25.0	 A12 \$60  TAB-A00 \$135 Right folding tablet with black supporting arm. Tablet is black. No left arm. Frame color BF/SF. Not Stackable with Tablet. Dimensions: 15.5" x 11.25" x 0.25"	 C5 STD Carpet Casters
			A12	406	431	461	501	546	596	656		DEPTH: 26.0	26.0		
			TAB-A00	466	491	521	561	606	656	716		HEIGHT: 33.0	33.0		
			TAB-A12	541	566	596	636	681	731	791		SEAT WIDTH: 18.0	18.0		
				581	606	636	676	721	771	831		SEAT DEPTH: 16.0	16.0		
												SEAT HEIGHT: 18.5	18.5		
												BACK WIDTH: 19.0	19.0		
												BACK HEIGHT: 17.5	17.5		
												COM: 0.8 YD	0.8 YD		
												WEIGHT: 17.0 LB	19.0 LB		
1315	GT	PLASTIC BACK & UPHOLSTERED SEAT GUEST STACKING WITH CASTERS - US	A00	A	B/COM	C	D	E	F	G	<ul style="list-style-type: none"> • Stacks 4 high on the floor • Stacks 10 high on the optional stacking dolly 	WIDTH: 21.0	25.0	 TAB-A12 \$175 Right folding tablet with black supporting arm and A12 left arm. Tablet is black. Frame color BF/SF. Not Stackable with Tablet	 C5S \$30 Hard Floor and Carpet Casters
			A12	451	476	506	546	591	641	701		DEPTH: 26.0	26.0		
			TAB-A00	511	536	566	606	651	701	761		HEIGHT: 33.0	33.0		
			TAB-A12	586	611	641	681	726	776	836		SEAT WIDTH: 18.0	18.0		
				626	651	681	721	766	816	876		SEAT DEPTH: 16.0	16.0		
												SEAT HEIGHT: 18.5	18.5		
												BACK WIDTH: 19.0	19.0		
												BACK HEIGHT: 17.5	17.5		
												COM: 0.8 YD	0.8 YD		
												WEIGHT: 17.0 LB	19.0 LB		
1360	GT	MESH BACK & UPHOLSTERED SEAT GUEST STACKING - US	A00	A	B/COM	C	D	E	F	G	<ul style="list-style-type: none"> • Stacks 4 high on the floor • Stacks 10 high on the optional stacking dolly • Black non-marring nylon glides • Three mesh colors in black plastic 	WIDTH: 21.0	25.0	 DL5 \$399 Stacking Dolly Stacks Chairs 10 High	
			A12	471	496	526	566	611	661	721		DEPTH: 26.0	26.0		
			TAB-A00	531	556	586	626	671	721	781		HEIGHT: 33.0	33.0		
			TAB-A12	606	631	661	701	746	796	856		SEAT WIDTH: 18.0	18.0		
				646	671	701	741	786	836	896		SEAT DEPTH: 16.0	16.0		
												SEAT HEIGHT: 18.5	18.5		
												BACK WIDTH: 19.0	19.0		
												BACK HEIGHT: 17.5	17.5		
												COM: 0.8 YD	0.8 YD		
												WEIGHT: 17.0 LB	19.0 LB		
1365	GT	MESH BACK & UPHOLSTERED SEAT GUEST STACKING WITH CASTERS - US	A00	A	B/COM	C	D	E	F	G	<ul style="list-style-type: none"> • Stacks 4 high on the floor • Stacks 10 high on the optional stacking dolly • Three mesh colors in black plastic 	WIDTH: 21.0	25.0	 GC1 \$30  GC2 \$30 Ganging Clip - 2 per Set GC1 - Armless-to-Armless GC2 - Arm-to-Arm	
			A12	516	541	571	611	656	706	766		DEPTH: 26.0	26.0		
			TAB-A00	576	601	631	671	716	766	826		HEIGHT: 33.0	33.0		
			TAB-A12	651	676	706	746	791	841	901		SEAT WIDTH: 18.0	18.0		
				691	716	746	786	831	881	941		SEAT DEPTH: 16.0	16.0		
												SEAT HEIGHT: 18.5	18.5		
												BACK WIDTH: 19.0	19.0		
												BACK HEIGHT: 17.5	17.5		
												COM: 0.8 YD	0.8 YD		
												WEIGHT: 17.0 LB	19.0 LB		

Careless stacking of chairs may scratch and damage frames. Due to the nature of vinyl upholstery, stacking may cause impressions on the seat. 9to5 Seating does not warrant the effects of the stacking on vinyl upholstery.

bella

name your game, bella is ready to play

GSA SIN # 33721

- Multi-purpose seating, including stacking, nesting, task and task stool models
- Perfect for collaborative, meeting, training and break room spaces
- Plastic, upholstered or mesh back options
- Warranted to 300 lbs.



UPHOLSTERED SEAT - US - TASK

CREATING BELLA MODEL NUMBER



PACKAGING NOTES

CODE	DESCRIPTION	LIST UPCHARGE
AB	ASSEMBLED IN BAG	\$0
BAC	BACK ASSEMBLED IN CARTON	\$0

MODEL	CONTROL	DESCRIPTION	ARM	FABRIC	FEATURES	WIDTH:	DEPTH:	HEIGHT:	SEAT WIDTH:	SEAT DEPTH:	SEAT HEIGHT:	BACK WIDTH:	BACK HEIGHT:	COM:	WEIGHT:
1325	B2	PLASTIC BACK & UPHOLSTERED SEAT BASIC TASK	A00	A B/COM C D E F G	<ul style="list-style-type: none"> • 360° swivel • Pneumatic cylinder height adjustment 	26.0	26.0	32.5-37.5	18.0	16.0	18.0-23.0	19.0	17.5	0.8 YD	26.5 LB
			A12	531 556 586 626 671 721 781											
1325	S3	PLASTIC BACK & UPHOLSTERED SEAT SWIVEL TILT	A00	A B/COM C D E F G	<ul style="list-style-type: none"> • Upright lock • Center knob tension adjustment • 360° swivel • Pneumatic cylinder height adjustment 	26.0	26.0	33-37.5	18.0	16.0	17.0-21.5	19.0	17.5	0.8 YD	27.5 LB
			A12	566 591 621 661 706 756 816											
1375	B2	MESH BACK & UPHOLSTERED SEAT BASIC TASK	A00	A B/COM C D E F G	<ul style="list-style-type: none"> • 360° swivel • Pneumatic cylinder height adjustment • Three mesh colors in black plastic 	26.0	26.0	32.5-37.5	18.0	16.0	18.0-23.0	19.0	17.5	0.8 YD	26.5 LB
			A12	596 621 651 691 736 786 846											
1375	S3	MESH BACK & UPHOLSTERED SEAT SWIVEL TILT	A00	A B/COM C D E F G	<ul style="list-style-type: none"> • Upright lock • Center knob tension adjustment • 360° swivel • Pneumatic cylinder height adjustment • Three mesh colors in black plastic 	26.0	26.0	33-37.5	18.0	16.0	17.0-21.5	19.0	17.5	0.8 YD	27.5 LB
			A12	631 656 686 726 771 821 881											

ARM OPTIONS

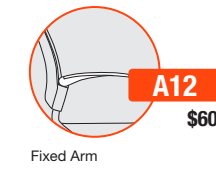

CASTER OPTIONS

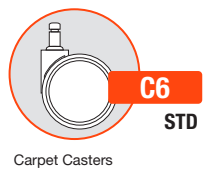

BASE OPTIONS



FRAME COLORS

BLACK BF	SILVER SF
-------------	--------------

MESH COLORS

M1	BLACK M11	GRAY M12	SILVER M13	M1 MESH NC
----	--------------	-------------	---------------	----------------------

PLASTIC COLORS*

BLACK SWAN P01	WHITE WHISPER P05	FEDERAL BLUE P11	DOVE GRAY P14	CLOUD GRAY P15
LAGOON BLUE P16	APPLE GREEN P17	LATTE P19		

(BACK AND SEAT)
*Mesh back frame is P01 Black Swan.

bella

name your game, bella is ready to play

GSA SIN # 33721

- Multi-purpose seating, including stacking, nesting, task and task stool models
- Perfect for collaborative, meeting, training and break room spaces
- Plastic, upholstered or mesh back options
- Warranted to 300 lbs.



CREATING BELLA MODEL NUMBER

MODEL NUMBER CONTROL ARMS FRAME COLOR UPHOLSTERY MESH COLOR GRADE PLASTIC COLOR BASE CASTERS PACKAGING

1 3 - B 2 - A - F - U S - M 1 - P - B A - C 6

* FOR ARMLESS USE CODE A00 * ONLY SELECT FOR MODELS 1376/137

PACKAGING NOTES

CODE	DESCRIPTION	LIST UPCHARGE
AB	ASSEMBLED IN BAG	\$0
BAC	BACK ASSEMBLED IN CARTON	\$0

UPHOLSTERED SEAT - US - STOOLS

MODEL	CONTROL	DESCRIPTION	ARM	FABRIC	FEATURES	WIDTH:	DEPTH:	HEIGHT:	SEAT WIDTH:	SEAT DEPTH:	SEAT HEIGHT:	BACK WIDTH:	BACK HEIGHT:	COM:	WEIGHT:	ARM OPTIONS	CASTER OPTIONS																															
1326	B2	PLASTIC BACK & UPHOLSTERED SEAT 10" STOOL BASIC TASK Use for work surfaces up to 42" high	A00	<table border="1"> <thead> <tr> <th>A</th> <th>B/COM</th> <th>C</th> <th>D</th> <th>E</th> <th>F</th> <th>G</th> </tr> </thead> <tbody> <tr> <td>656</td> <td>681</td> <td>711</td> <td>751</td> <td>796</td> <td>846</td> <td>906</td> </tr> <tr> <td>716</td> <td>741</td> <td>771</td> <td>811</td> <td>856</td> <td>906</td> <td>966</td> </tr> </tbody> </table>	A	B/COM	C	D	E	F	G	656	681	711	751	796	846	906	716	741	771	811	856	906	966	<ul style="list-style-type: none"> • 360° swivel • Pneumatic cylinder height adjustment 	25.0	26.0	40.0-50.0	18.0	16.0	25.5-35.5	19.0	17.5	0.8 YD	32.5 LB	A12 \$60	C6 STD Carpet Casters										
A	B/COM		C	D	E	F	G																																									
656	681	711	751	796	846	906																																										
716	741	771	811	856	906	966																																										
A12																																																
1328	B2	PLASTIC BACK & UPHOLSTERED SEAT 8" STOOL BASIC TASK Use for work surfaces up to 36" high	A00	<table border="1"> <thead> <tr> <th>A</th> <th>B/COM</th> <th>C</th> <th>D</th> <th>E</th> <th>F</th> <th>G</th> </tr> </thead> <tbody> <tr> <td>656</td> <td>681</td> <td>711</td> <td>751</td> <td>796</td> <td>846</td> <td>906</td> </tr> <tr> <td>716</td> <td>741</td> <td>771</td> <td>811</td> <td>856</td> <td>906</td> <td>966</td> </tr> </tbody> </table>	A	B/COM	C	D	E	F	G	656	681	711	751	796	846	906	716	741	771	811	856	906	966	<ul style="list-style-type: none"> • 360° swivel • Pneumatic cylinder height adjustment 	25.0	26.0	36.0-44.0	18.0	16.0	21.5-29.5	19.0	17.5	0.8 YD	31.5 LB	BA11B STD	BA12B/P/S \$110 BA12B - Black Powder Coat BA12P - Polished BA12S - Silver Powder Coat										
A	B/COM		C	D	E	F	G																																									
656	681	711	751	796	846	906																																										
716	741	771	811	856	906	966																																										
A12																																																
1376	B2	MESH BACK & UPHOLSTERED SEAT 10" STOOL BASIC TASK Use for work surfaces up to 42" high	A00	<table border="1"> <thead> <tr> <th>A</th> <th>B/COM</th> <th>C</th> <th>D</th> <th>E</th> <th>F</th> <th>G</th> </tr> </thead> <tbody> <tr> <td>721</td> <td>746</td> <td>776</td> <td>816</td> <td>861</td> <td>911</td> <td>971</td> </tr> <tr> <td>781</td> <td>806</td> <td>836</td> <td>876</td> <td>921</td> <td>971</td> <td>1031</td> </tr> </tbody> </table>	A	B/COM	C	D	E	F	G	721	746	776	816	861	911	971	781	806	836	876	921	971	1031	<ul style="list-style-type: none"> • 360° swivel • Pneumatic cylinder height adjustment • Three mesh colors in black plastic 	25.0	26.0	40.0-50.0	18.0	16.0	25.5-35.5	19.0	17.5	0.8 YD	32.5 LB	BLACK BF	SILVER SF										
A	B/COM		C	D	E	F	G																																									
721	746	776	816	861	911	971																																										
781	806	836	876	921	971	1031																																										
A12																																																
1378	B2	MESH BACK & UPHOLSTERED SEAT 8" STOOL BASIC TASK Use for work surfaces up to 36" high	A00	<table border="1"> <thead> <tr> <th>A</th> <th>B/COM</th> <th>C</th> <th>D</th> <th>E</th> <th>F</th> <th>G</th> </tr> </thead> <tbody> <tr> <td>721</td> <td>746</td> <td>776</td> <td>816</td> <td>861</td> <td>911</td> <td>971</td> </tr> <tr> <td>781</td> <td>806</td> <td>836</td> <td>876</td> <td>921</td> <td>971</td> <td>1031</td> </tr> </tbody> </table>	A	B/COM	C	D	E	F	G	721	746	776	816	861	911	971	781	806	836	876	921	971	1031	<ul style="list-style-type: none"> • 360° swivel • Pneumatic cylinder height adjustment • Three mesh colors in black plastic 	25.0	26.0	36.0-44.0	18.0	16.0	21.5-29.5	19.0	17.5	0.8 YD	31.5 LB	M1 MESH NC	<table border="1"> <thead> <tr> <th>BLACK SWAN P01</th> <th>WHITE WHISPER P05</th> <th>FEDERAL BLUE P11</th> <th>DOVE GRAY P14</th> <th>CLOUD GRAY P15</th> </tr> </thead> <tbody> <tr> <td>LAGOON BLUE P16</td> <td>APPLE GREEN P17</td> <td>LATTE P19</td> <td></td> <td></td> </tr> </tbody> </table>	BLACK SWAN P01	WHITE WHISPER P05	FEDERAL BLUE P11	DOVE GRAY P14	CLOUD GRAY P15	LAGOON BLUE P16	APPLE GREEN P17	LATTE P19		
A	B/COM		C	D	E	F	G																																									
721	746	776	816	861	911	971																																										
781	806	836	876	921	971	1031																																										
BLACK SWAN P01	WHITE WHISPER P05	FEDERAL BLUE P11	DOVE GRAY P14	CLOUD GRAY P15																																												
LAGOON BLUE P16	APPLE GREEN P17	LATTE P19																																														
A12																																																

FRAME COLORS

BLACK BF	SILVER SF
-------------	--------------

MESH COLORS

M1	BLACK M11	GRAY M12	SILVER M13	M1 MESH NC
----	--------------	-------------	---------------	----------------------

PLASTIC COLORS*

BLACK SWAN P01	WHITE WHISPER P05	FEDERAL BLUE P11	DOVE GRAY P14	CLOUD GRAY P15
LAGOON BLUE P16	APPLE GREEN P17	LATTE P19		

(BACK AND SEAT)

*Mesh back frame is P01 Black Swan.

bella

name your game, bella is ready to play

GSA SIN # 33721

- Multi-purpose seating, including stacking, nesting, task and task stool models
- Perfect for collaborative, meeting, training and break room spaces
- Plastic, upholstered or mesh back options
- Warranted to 300 lbs.



FULLY UPHOLSTERED - UP - GUEST

CREATING BELLA MODEL NUMBER

MODEL NUMBER CONTROL ARMS FRAME COLOR UPHOLSTERY GRADE PLASTIC COLOR CASTERS PACKAGING OPTIONS

1 3 - GT - A - F - UP - P - C5 -

* FOR ARMLESS USE CODE A00 * ONLY SELECT CASTER CODE FOR MODELS 1310/1305

PACKAGING NOTES

CODE	DESCRIPTION	LIST UPCHARGE
AB	ASSEMBLED IN BAG	\$0
AC	ASSEMBLED IN CARTON	\$0

BELLA STACK CHAIRS SHIP UP TO 3 PER CARTON

MODEL	CONTROL	DESCRIPTION	ARM	FABRIC	FEATURES																																			
1310	GT	UPHOLSTERED BACK & UPHOLSTERED SEAT GUEST STACKING	A00	<table border="1"> <thead> <tr> <th>A</th> <th>B/COM</th> <th>C</th> <th>D</th> <th>E</th> <th>F</th> <th>G</th> </tr> </thead> <tbody> <tr> <td>467</td> <td>497</td> <td>527</td> <td>582</td> <td>632</td> <td>677</td> <td>742</td> </tr> <tr> <td>527</td> <td>557</td> <td>587</td> <td>642</td> <td>692</td> <td>737</td> <td>802</td> </tr> <tr> <td>602</td> <td>632</td> <td>662</td> <td>717</td> <td>767</td> <td>812</td> <td>877</td> </tr> <tr> <td>642</td> <td>672</td> <td>702</td> <td>757</td> <td>807</td> <td>852</td> <td>917</td> </tr> </tbody> </table>	A	B/COM	C	D	E	F	G	467	497	527	582	632	677	742	527	557	587	642	692	737	802	602	632	662	717	767	812	877	642	672	702	757	807	852	917	<ul style="list-style-type: none"> • Stacks 4 high on the floor • Stacks 10 high on the optional stacking dolly • Black non-marring nylon glides
A	B/COM		C	D	E	F	G																																	
467	497		527	582	632	677	742																																	
527	557		587	642	692	737	802																																	
602	632	662	717	767	812	877																																		
642	672	702	757	807	852	917																																		
			A12	<table border="1"> <thead> <tr> <th>A</th> <th>B/COM</th> <th>C</th> <th>D</th> <th>E</th> <th>F</th> <th>G</th> </tr> </thead> <tbody> <tr> <td>512</td> <td>542</td> <td>572</td> <td>627</td> <td>677</td> <td>722</td> <td>787</td> </tr> <tr> <td>572</td> <td>602</td> <td>632</td> <td>687</td> <td>737</td> <td>782</td> <td>847</td> </tr> <tr> <td>647</td> <td>677</td> <td>707</td> <td>762</td> <td>812</td> <td>857</td> <td>922</td> </tr> <tr> <td>687</td> <td>717</td> <td>747</td> <td>802</td> <td>852</td> <td>897</td> <td>962</td> </tr> </tbody> </table>	A	B/COM	C	D	E	F	G	512	542	572	627	677	722	787	572	602	632	687	737	782	847	647	677	707	762	812	857	922	687	717	747	802	852	897	962	<ul style="list-style-type: none"> • Stacks 4 high on the floor • Stacks 10 high on the optional stacking dolly
A	B/COM	C	D	E	F	G																																		
512	542	572	627	677	722	787																																		
572	602	632	687	737	782	847																																		
647	677	707	762	812	857	922																																		
687	717	747	802	852	897	962																																		
			TAB-A00																																					
			TAB-A12																																					
1315	GT	UPHOLSTERED BACK & UPHOLSTERED SEAT GUEST STACKING WITH CASTERS	A00	<table border="1"> <thead> <tr> <th>A</th> <th>B/COM</th> <th>C</th> <th>D</th> <th>E</th> <th>F</th> <th>G</th> </tr> </thead> <tbody> <tr> <td>512</td> <td>542</td> <td>572</td> <td>627</td> <td>677</td> <td>722</td> <td>787</td> </tr> <tr> <td>572</td> <td>602</td> <td>632</td> <td>687</td> <td>737</td> <td>782</td> <td>847</td> </tr> <tr> <td>647</td> <td>677</td> <td>707</td> <td>762</td> <td>812</td> <td>857</td> <td>922</td> </tr> <tr> <td>687</td> <td>717</td> <td>747</td> <td>802</td> <td>852</td> <td>897</td> <td>962</td> </tr> </tbody> </table>	A	B/COM	C	D	E	F	G	512	542	572	627	677	722	787	572	602	632	687	737	782	847	647	677	707	762	812	857	922	687	717	747	802	852	897	962	<ul style="list-style-type: none"> • Stacks 4 high on the floor • Stacks 10 high on the optional stacking dolly
A	B/COM		C	D	E	F	G																																	
512	542		572	627	677	722	787																																	
572	602		632	687	737	782	847																																	
647	677	707	762	812	857	922																																		
687	717	747	802	852	897	962																																		
			A12																																					
			TAB-A00																																					
			TAB-A12																																					

	ARMLESS	W/ ARMS
WIDTH:	21.0	25.0
DEPTH:	26.0	26.0
HEIGHT:	33.0	33.0
SEAT WIDTH:	18.0	18.0
SEAT DEPTH:	16.0	16.0
SEAT HEIGHT:	18.5	18.5
BACK WIDTH:	19.0	19.0
BACK HEIGHT:	17.5	17.5
COM:	0.8 YD	0.8 YD
WEIGHT:	17.0 LB	20.0 LB

ARM OPTIONS

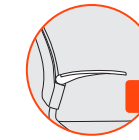

Fixed Arm

A12
\$60



TAB-A00
\$135

Right folding tablet with black supporting arm. Tablet is black. No left arm. Frame color BF/SF. Not Stackable with Tablet. Dimensions: 15.5" x 11.25" x 0.25"



TAB-A12
\$175

Right folding tablet with black supporting arm and A12 left arm. Tablet is black. Frame color BF/SF. Not Stackable with Tablet

CASTER OPTIONS

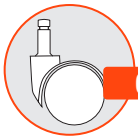

C5
STD

Carpet Casters



C5S
\$30

Hard Floor and Carpet Casters

ACCESSORIES



DL5
\$399

Stacking Dolly Stacks Chairs 10 High

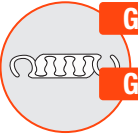

GC1
\$30

GC2
\$30

Ganging Clip - 2 per Set
GC1 - Armless-to-Armless
GC2 - Arm-to-Arm

FRAME COLORS

BLACK BF	SILVER SF
-------------	--------------

PLASTIC COLORS*

BLACK SWAN P01	WHITE WHISPER P05	FEDERAL BLUE P11	DOVE GRAY P14	CLOUD GRAY P15
LAGOON BLUE P16	APPLE GREEN P17	LATTE P19		

(BACK AND SEAT)

Careless stacking of chairs may scratch and damage frames. Due to the nature of vinyl upholstery, stacking may cause impressions on the seat. 9to5 Seating does not warrant the effects of the stacking on vinyl upholstery.

bella

name your game, bella is ready to play

GSA SIN # 33721

- Multi-purpose seating, including stacking, nesting, task and task stool models
- Perfect for collaborative, meeting, training and break room spaces
- Plastic, upholstered or mesh back options
- Warranted to 300 lbs.



CREATING BELLA MODEL NUMBER



PACKAGING NOTES

CODE	DESCRIPTION	LIST UPCHARGE
AB	ASSEMBLED IN BAG	\$0
BAC	BACK ASSEMBLED IN CARTON	\$0

FULLY UPHOLSTERED - UP - TASK & STOOLS

MODEL	CONTROL	DESCRIPTION	ARM	FABRIC							FEATURES	DIMENSIONS
				A	B/COM	C	D	E	F	G		
1325	B2	UPHOLSTERED BACK & UPHOLSTERED SEAT BASIC TASK - UP	A00	592	622	652	707	757	802	867	<ul style="list-style-type: none"> • 360° swivel • Pneumatic cylinder height adjustment 	WIDTH: 25.0 DEPTH: 26.0 HEIGHT: 32.5-37.5 SEAT WIDTH: 18.0 SEAT DEPTH: 16.0 SEAT HEIGHT: 18.0-23.0 BACK WIDTH: 19.0 BACK HEIGHT: 17.5 COM: 0.8 YD WEIGHT: 30.0 LB
			A12	652	682	712	767	817	862	927		
1325	S3	UPHOLSTERED BACK & UPHOLSTERED SEAT SWIVEL TILT - UP	A00	627	657	687	742	792	837	902	<ul style="list-style-type: none"> • Upright lock • Center knob tension adjustment • 360° swivel • Pneumatic cylinder height adjustment 	WIDTH: 25.0 DEPTH: 26.0 HEIGHT: 33-37.5 SEAT WIDTH: 18.0 SEAT DEPTH: 16.0 SEAT HEIGHT: 18.0-23.0 BACK WIDTH: 19.0 BACK HEIGHT: 17.5 COM: 0.8 YD WEIGHT: 31.0 LB
			A12	687	717	747	802	852	897	962		
1326	B2	UPHOLSTERED BACK & UPHOLSTERED SEAT 10" STOOL BASIC TASK - UP	A00	717	747	777	832	882	927	992	<ul style="list-style-type: none"> • 360° swivel • Pneumatic cylinder height adjustment 	WIDTH: 25.0 DEPTH: 26.0 HEIGHT: 40.0-50.0 SEAT WIDTH: 18.0 SEAT DEPTH: 16.0 SEAT HEIGHT: 25.5-35.5 BACK WIDTH: 19.0 BACK HEIGHT: 17.5 COM: 0.8 YD WEIGHT: 36.0 LB
			A12	777	807	837	892	942	987	1052		
1328	B2	UPHOLSTERED BACK & UPHOLSTERED SEAT 8" STOOL BASIC TASK - UP	A00	717	747	777	832	882	927	992	<ul style="list-style-type: none"> • 360° swivel • Pneumatic cylinder height adjustment 	WIDTH: 25.0 DEPTH: 26.0 HEIGHT: 36.0-44.0 SEAT WIDTH: 18.0 SEAT DEPTH: 16.0 SEAT HEIGHT: 21.5-29.5 BACK WIDTH: 19.0 BACK HEIGHT: 17.5 COM: 0.8 YD WEIGHT: 35.0 LB
			A12	777	807	837	892	942	987	1052		

ARM OPTIONS

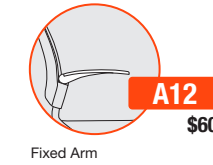

CASTER OPTIONS



BASE OPTIONS

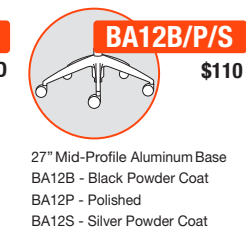

FRAME COLORS

BLACK BF	SILVER SF
-------------	--------------

PLASTIC COLORS*

BLACK SWAN P01	WHITE WHISPER P05	FEDERAL BLUE P11	DOVE GRAY P14	CLOUD GRAY P15
LAGOON BLUE P16	APPLE GREEN P17	LATTE P19		

(BACK AND SEAT)

bristol

seamless integration into your office's architecture

MID-BACK

GSA SIN # 33721

- Task, stool, conference and executive seating
- Ratchet back lumbar height adjustment
- Ballistic nylon optional
- Warranted to 300 lbs.



CREATING BRISTOL MODEL NUMBER



PACKAGING NOTES

CODE	DESCRIPTION	LIST UPCHARGE
AB	ASSEMBLED IN BAG	\$0
PAC	PARTIALLY ASSEMBLED IN CARTON	\$0
BAC	BACK ASSEMBLED IN CARTON	\$80

MODEL	CONTROL	DESCRIPTION	ARM	FABRIC/LEATHER	FEATURES	DIMENSIONS	ARM OPTIONS	CASTER OPTIONS																																																																																						
2360	S2	MID-BACK SWIVEL TILT	A00	<table border="1"> <thead> <tr> <th>A</th> <th>B/COM</th> <th>C</th> <th>D</th> <th>E</th> <th>F</th> <th>G</th> <th>L3/COL</th> <th>L4</th> <th>L5</th> </tr> </thead> <tbody> <tr><td>957</td><td>1007</td><td>1042</td><td>1087</td><td>1137</td><td>1202</td><td>1282</td><td>1192</td><td>1257</td><td>1457</td></tr> <tr><td>A8B/S</td><td>1062</td><td>1112</td><td>1147</td><td>1192</td><td>1242</td><td>1307</td><td>1387</td><td>1297</td><td>1362</td><td>1562</td></tr> <tr><td>A9B/S</td><td>1072</td><td>1122</td><td>1157</td><td>1202</td><td>1252</td><td>1317</td><td>1397</td><td>1307</td><td>1372</td><td>1572</td></tr> <tr><td>A10</td><td>1067</td><td>1117</td><td>1152</td><td>1197</td><td>1247</td><td>1312</td><td>1392</td><td>1302</td><td>1367</td><td>1567</td></tr> <tr><td>A19</td><td>1192</td><td>1242</td><td>1277</td><td>1322</td><td>1372</td><td>1437</td><td>1517</td><td>1427</td><td>1492</td><td>1692</td></tr> <tr><td>A36</td><td>1082</td><td>1132</td><td>1167</td><td>1212</td><td>1262</td><td>1327</td><td>1407</td><td>1317</td><td>1382</td><td>1582</td></tr> <tr><td>A37</td><td>1097</td><td>1147</td><td>1182</td><td>1227</td><td>1277</td><td>1342</td><td>1422</td><td>1332</td><td>1397</td><td>1597</td></tr> </tbody> </table>	A	B/COM	C	D	E	F	G	L3/COL	L4	L5	957	1007	1042	1087	1137	1202	1282	1192	1257	1457	A8B/S	1062	1112	1147	1192	1242	1307	1387	1297	1362	1562	A9B/S	1072	1122	1157	1202	1252	1317	1397	1307	1372	1572	A10	1067	1117	1152	1197	1247	1312	1392	1302	1367	1567	A19	1192	1242	1277	1322	1372	1437	1517	1427	1492	1692	A36	1082	1132	1167	1212	1262	1327	1407	1317	1382	1582	A37	1097	1147	1182	1227	1277	1342	1422	1332	1397	1597	<ul style="list-style-type: none"> • Upright lock • Center knob tension adjustment • 360° swivel • Pneumatic cylinder height adjustment 	<p>WIDTH: 25.0</p> <p>DEPTH: 26.0</p> <p>HEIGHT: 37.5-45.5</p> <p>SEAT WIDTH: 20.0</p> <p>SEAT DEPTH: 19.0</p> <p>SEAT HEIGHT: 16.5-21.0</p> <p>SEAT HEIGHT W/ SEAT SLIDER: 18-22.5</p> <p>BACK WIDTH: 20.0</p> <p>BACK HEIGHT: 19.0-21.5</p> <p>COM: 1.4 YD</p> <p>COL: 33.0 SQ FT</p> <p>WEIGHT: 30.0 LB</p>	<p>A8B/S \$105</p> <p>Height Adjustable Arm A8B - Black A8S - Silver</p> <p>A9B/S \$115</p> <p>Height/Width Adjustable Arm A9B - Black A9S - Silver</p>	<p>C6 STD</p> <p>Large Diameter Carpet Casters</p>
A	B/COM		C	D	E	F	G	L3/COL	L4	L5																																																																																				
957	1007		1042	1087	1137	1202	1282	1192	1257	1457																																																																																				
A8B/S	1062		1112	1147	1192	1242	1307	1387	1297	1362	1562																																																																																			
A9B/S	1072		1122	1157	1202	1252	1317	1397	1307	1372	1572																																																																																			
A10	1067		1117	1152	1197	1247	1312	1392	1302	1367	1567																																																																																			
A19	1192		1242	1277	1322	1372	1437	1517	1427	1492	1692																																																																																			
A36	1082	1132	1167	1212	1262	1327	1407	1317	1382	1582																																																																																				
A37	1097	1147	1182	1227	1277	1342	1422	1332	1397	1597																																																																																				
				SEAT SLIDER (SS) - ADD \$60 - FACTORY INSTALLED																																																																																										
2360	R1	MID-BACK ROCKING TILT	A00	<table border="1"> <thead> <tr> <th>A</th> <th>B/COM</th> <th>C</th> <th>D</th> <th>E</th> <th>F</th> <th>G</th> <th>L3/COL</th> <th>L4</th> <th>L5</th> </tr> </thead> <tbody> <tr><td>1007</td><td>1057</td><td>1092</td><td>1137</td><td>1187</td><td>1252</td><td>1332</td><td>1242</td><td>1307</td><td>1507</td></tr> <tr><td>A8B/S</td><td>1112</td><td>1162</td><td>1197</td><td>1242</td><td>1292</td><td>1357</td><td>1437</td><td>1347</td><td>1412</td><td>1612</td></tr> <tr><td>A9B/S</td><td>1122</td><td>1172</td><td>1207</td><td>1252</td><td>1302</td><td>1367</td><td>1447</td><td>1357</td><td>1422</td><td>1622</td></tr> <tr><td>A10</td><td>1117</td><td>1167</td><td>1202</td><td>1247</td><td>1297</td><td>1362</td><td>1442</td><td>1352</td><td>1417</td><td>1617</td></tr> <tr><td>A19</td><td>1242</td><td>1292</td><td>1327</td><td>1372</td><td>1422</td><td>1487</td><td>1567</td><td>1477</td><td>1542</td><td>1742</td></tr> <tr><td>A36</td><td>1132</td><td>1182</td><td>1217</td><td>1262</td><td>1312</td><td>1377</td><td>1457</td><td>1367</td><td>1432</td><td>1632</td></tr> <tr><td>A37</td><td>1147</td><td>1197</td><td>1232</td><td>1277</td><td>1327</td><td>1392</td><td>1472</td><td>1382</td><td>1447</td><td>1647</td></tr> </tbody> </table>	A	B/COM	C	D	E	F	G	L3/COL	L4	L5	1007	1057	1092	1137	1187	1252	1332	1242	1307	1507	A8B/S	1112	1162	1197	1242	1292	1357	1437	1347	1412	1612	A9B/S	1122	1172	1207	1252	1302	1367	1447	1357	1422	1622	A10	1117	1167	1202	1247	1297	1362	1442	1352	1417	1617	A19	1242	1292	1327	1372	1422	1487	1567	1477	1542	1742	A36	1132	1182	1217	1262	1312	1377	1457	1367	1432	1632	A37	1147	1197	1232	1277	1327	1392	1472	1382	1447	1647	<ul style="list-style-type: none"> • Infinite back angle adjustment • Infinite tilt lock • Center knob tension adjustment • 360° swivel • Pneumatic cylinder height adjustment 	<p>WIDTH: 25.0</p> <p>DEPTH: 26.0</p> <p>HEIGHT: 38.5-45.5</p> <p>SEAT WIDTH: 20.0</p> <p>SEAT DEPTH: 19.0</p> <p>SEAT HEIGHT: 17.5-22.5</p> <p>SEAT HEIGHT W/ SEAT SLIDER: 19.0-23.5</p> <p>BACK WIDTH: 20.0</p> <p>BACK HEIGHT: 19.0-21.5</p> <p>COM: 1.4 YD</p> <p>COL: 33.0 SQ FT</p> <p>WEIGHT: 35.0 LB</p>	<p>A10 \$110</p> <p>Soft Touch C-Shaped Arm</p> <p>A19 \$235</p> <p>Polished Aluminum C-Shape Arm</p>	<p>C6S \$35</p> <p>Large Diameter Hard Floor and Carpet Casters</p>
A	B/COM		C	D	E	F	G	L3/COL	L4	L5																																																																																				
1007	1057		1092	1137	1187	1252	1332	1242	1307	1507																																																																																				
A8B/S	1112		1162	1197	1242	1292	1357	1437	1347	1412	1612																																																																																			
A9B/S	1122		1172	1207	1252	1302	1367	1447	1357	1422	1622																																																																																			
A10	1117		1167	1202	1247	1297	1362	1442	1352	1417	1617																																																																																			
A19	1242		1292	1327	1372	1422	1487	1567	1477	1542	1742																																																																																			
A36	1132	1182	1217	1262	1312	1377	1457	1367	1432	1632																																																																																				
A37	1147	1197	1232	1277	1327	1392	1472	1382	1447	1647																																																																																				
				SEAT SLIDER (SS) - ADD \$60 - FACTORY INSTALLED																																																																																										
2360	Y2	MID-BACK HEAVY DUTY SYNCHRO TILT	A00	<table border="1"> <thead> <tr> <th>A</th> <th>B/COM</th> <th>C</th> <th>D</th> <th>E</th> <th>F</th> <th>G</th> <th>L3/COL</th> <th>L4</th> <th>L5</th> </tr> </thead> <tbody> <tr><td>1037</td><td>1087</td><td>1122</td><td>1167</td><td>1217</td><td>1282</td><td>1362</td><td>1272</td><td>1337</td><td>1537</td></tr> <tr><td>A8B/S</td><td>1142</td><td>1192</td><td>1227</td><td>1272</td><td>1322</td><td>1387</td><td>1467</td><td>1377</td><td>1442</td><td>1642</td></tr> <tr><td>A9B/S</td><td>1152</td><td>1202</td><td>1237</td><td>1282</td><td>1332</td><td>1397</td><td>1477</td><td>1387</td><td>1452</td><td>1652</td></tr> <tr><td>A10</td><td>1147</td><td>1197</td><td>1232</td><td>1277</td><td>1327</td><td>1392</td><td>1472</td><td>1382</td><td>1447</td><td>1647</td></tr> <tr><td>A19</td><td>1272</td><td>1322</td><td>1357</td><td>1402</td><td>1452</td><td>1517</td><td>1597</td><td>1507</td><td>1572</td><td>1772</td></tr> <tr><td>A36</td><td>1162</td><td>1212</td><td>1247</td><td>1292</td><td>1342</td><td>1407</td><td>1487</td><td>1397</td><td>1462</td><td>1662</td></tr> <tr><td>A37</td><td>1177</td><td>1227</td><td>1262</td><td>1307</td><td>1357</td><td>1422</td><td>1502</td><td>1412</td><td>1477</td><td>1677</td></tr> </tbody> </table>	A	B/COM	C	D	E	F	G	L3/COL	L4	L5	1037	1087	1122	1167	1217	1282	1362	1272	1337	1537	A8B/S	1142	1192	1227	1272	1322	1387	1467	1377	1442	1642	A9B/S	1152	1202	1237	1282	1332	1397	1477	1387	1452	1652	A10	1147	1197	1232	1277	1327	1392	1472	1382	1447	1647	A19	1272	1322	1357	1402	1452	1517	1597	1507	1572	1772	A36	1162	1212	1247	1292	1342	1407	1487	1397	1462	1662	A37	1177	1227	1262	1307	1357	1422	1502	1412	1477	1677	<ul style="list-style-type: none"> • 4-position tilt lock • Side knob tension adjustment • 2:1 back-to-seat tilt ratio • 360° swivel • Pneumatic cylinder height adjustment 	<p>WIDTH: 25.0</p> <p>DEPTH: 26.0</p> <p>HEIGHT: 38.5-45.5</p> <p>SEAT WIDTH: 20.0</p> <p>SEAT DEPTH: 19.0</p> <p>SEAT HEIGHT: 17.5-22.0</p> <p>SEAT HEIGHT W/ SEAT SLIDER: 19.0-23.5</p> <p>BACK WIDTH: 20.0</p> <p>BACK HEIGHT: 19.0-21.5</p> <p>COM: 1.4 YD</p> <p>COL: 33.0 SQ FT</p> <p>WEIGHT: 37.0 LB</p>	<p>BA11B STD</p> <p>27" Mid-Profile Nylon Base BA11B - Black</p> <p>BA12B/P/S \$110</p> <p>27" Mid-Profile Aluminum Base BA12B - Black Powder Coat BA12P - Polished BA12S - Silver Powder Coat (C7 Chrome-Accented Casters Standard with Polished Base)</p>	
A	B/COM		C	D	E	F	G	L3/COL	L4	L5																																																																																				
1037	1087		1122	1167	1217	1282	1362	1272	1337	1537																																																																																				
A8B/S	1142		1192	1227	1272	1322	1387	1467	1377	1442	1642																																																																																			
A9B/S	1152		1202	1237	1282	1332	1397	1477	1387	1452	1652																																																																																			
A10	1147		1197	1232	1277	1327	1392	1472	1382	1447	1647																																																																																			
A19	1272		1322	1357	1402	1452	1517	1597	1507	1572	1772																																																																																			
A36	1162	1212	1247	1292	1342	1407	1487	1397	1462	1662																																																																																				
A37	1177	1227	1262	1307	1357	1422	1502	1412	1477	1677																																																																																				
				SEAT SLIDER (SS) - ADD \$60 - FACTORY INSTALLED																																																																																										
2360	M1	MID-BACK MULTI-FUNCTION	A00	<table border="1"> <thead> <tr> <th>A</th> <th>B/COM</th> <th>C</th> <th>D</th> <th>E</th> <th>F</th> <th>G</th> <th>L3/COL</th> <th>L4</th> <th>L5</th> </tr> </thead> <tbody> <tr><td>1057</td><td>1107</td><td>1142</td><td>1187</td><td>1237</td><td>1302</td><td>1382</td><td>1292</td><td>1357</td><td>1557</td></tr> <tr><td>A8B/S</td><td>1162</td><td>1212</td><td>1247</td><td>1292</td><td>1342</td><td>1407</td><td>1487</td><td>1397</td><td>1462</td><td>1662</td></tr> <tr><td>A9B/S</td><td>1172</td><td>1222</td><td>1257</td><td>1302</td><td>1352</td><td>1417</td><td>1497</td><td>1407</td><td>1472</td><td>1672</td></tr> <tr><td>A10</td><td>1167</td><td>1217</td><td>1252</td><td>1297</td><td>1347</td><td>1412</td><td>1492</td><td>1402</td><td>1467</td><td>1667</td></tr> <tr><td>A19</td><td>1292</td><td>1342</td><td>1377</td><td>1422</td><td>1472</td><td>1537</td><td>1617</td><td>1527</td><td>1592</td><td>1792</td></tr> <tr><td>A36</td><td>1182</td><td>1232</td><td>1267</td><td>1312</td><td>1362</td><td>1427</td><td>1507</td><td>1417</td><td>1482</td><td>1682</td></tr> <tr><td>A37</td><td>1197</td><td>1247</td><td>1282</td><td>1327</td><td>1377</td><td>1442</td><td>1522</td><td>1432</td><td>1497</td><td>1697</td></tr> </tbody> </table>	A	B/COM	C	D	E	F	G	L3/COL	L4	L5	1057	1107	1142	1187	1237	1302	1382	1292	1357	1557	A8B/S	1162	1212	1247	1292	1342	1407	1487	1397	1462	1662	A9B/S	1172	1222	1257	1302	1352	1417	1497	1407	1472	1672	A10	1167	1217	1252	1297	1347	1412	1492	1402	1467	1667	A19	1292	1342	1377	1422	1472	1537	1617	1527	1592	1792	A36	1182	1232	1267	1312	1362	1427	1507	1417	1482	1682	A37	1197	1247	1282	1327	1377	1442	1522	1432	1497	1697	<ul style="list-style-type: none"> • Infinite back angle adjustment • 6° forward tilt • Center knob tension adjustment • 360° swivel • Pneumatic cylinder height adjustment 	<p>WIDTH: 25.0</p> <p>DEPTH: 26.0</p> <p>HEIGHT: 38.5-45.5</p> <p>SEAT WIDTH: 20.0</p> <p>SEAT DEPTH: 19.0</p> <p>SEAT HEIGHT: 17.5-22.0</p> <p>SEAT HEIGHT W/ SEAT SLIDER: 19.0-23.5</p> <p>BACK WIDTH: 20.0</p> <p>BACK HEIGHT: 19.0-21.5</p> <p>COM: 1.4 YD</p> <p>COL: 33.0 SQ FT</p> <p>WEIGHT: 39.0 LB</p>	<p>SS \$60</p> <p>Seat Slider 2.5" Side Paddle Activated</p> <p>BN1 \$35</p> <p>BN2 N/C</p> <p>Upholstered Outer Back in Black Ballistic Nylon BN1 - with Grade A Only BN2 - with Grade B and Up</p> <p>HD \$125</p> <p>Heavy Duty Multi-Shift Upgrade to 350 lb. Includes BA12 High Profile Aluminum Base (Y2 Control only)</p>	
A	B/COM		C	D	E	F	G	L3/COL	L4	L5																																																																																				
1057	1107		1142	1187	1237	1302	1382	1292	1357	1557																																																																																				
A8B/S	1162		1212	1247	1292	1342	1407	1487	1397	1462	1662																																																																																			
A9B/S	1172		1222	1257	1302	1352	1417	1497	1407	1472	1672																																																																																			
A10	1167		1217	1252	1297	1347	1412	1492	1402	1467	1667																																																																																			
A19	1292		1342	1377	1422	1472	1537	1617	1527	1592	1792																																																																																			
A36	1182	1232	1267	1312	1362	1427	1507	1417	1482	1682																																																																																				
A37	1197	1247	1282	1327	1377	1442	1522	1432	1497	1697																																																																																				
				SEAT SLIDER (SS) - ADD \$60 - FACTORY INSTALLED																																																																																										

bristol

seamless integration into your office's architecture

GSA SIN # 33721

- Task, stool, conference and executive seating
- Ratchet back lumbar height adjustment
- Ballistic nylon optional
- Warranted to 300 lbs.



CREATING BRISTOL MODEL NUMBER



PACKAGING NOTES

CODE	DESCRIPTION	LIST UPCHARGE
AB	ASSEMBLED IN BAG	\$0
PAC	PARTIALLY ASSEMBLED IN CARTON	\$0
BAC	BACK ASSEMBLED IN CARTON	\$80

MID-BACK STOOLS

MODEL	CONTROL	DESCRIPTION	ARM	FABRIC/LEATHER	FEATURES	DIMENSIONS	ARM OPTIONS	CASTER OPTIONS																																																																																	
2366	P1	MID-BACK 10" STOOL POSTURE BACK Use for work surfaces up to 42" high	A00	<table border="1"> <thead> <tr> <th>A</th> <th>B/COM</th> <th>C</th> <th>D</th> <th>E</th> <th>F</th> <th>G</th> <th>L3/COL</th> <th>L4</th> <th>L5</th> </tr> </thead> <tbody> <tr><td>1072</td><td>1122</td><td>1157</td><td>1202</td><td>1252</td><td>1317</td><td>1397</td><td>1307</td><td>1372</td><td>1572</td></tr> <tr><td>1177</td><td>1227</td><td>1262</td><td>1307</td><td>1357</td><td>1422</td><td>1502</td><td>1412</td><td>1477</td><td>1677</td></tr> <tr><td>1187</td><td>1237</td><td>1272</td><td>1317</td><td>1367</td><td>1432</td><td>1512</td><td>1422</td><td>1487</td><td>1687</td></tr> <tr><td>1182</td><td>1232</td><td>1267</td><td>1312</td><td>1362</td><td>1427</td><td>1507</td><td>1417</td><td>1482</td><td>1682</td></tr> <tr><td>1307</td><td>1357</td><td>1392</td><td>1437</td><td>1487</td><td>1552</td><td>1632</td><td>1542</td><td>1607</td><td>1807</td></tr> <tr><td>1197</td><td>1247</td><td>1282</td><td>1327</td><td>1377</td><td>1442</td><td>1522</td><td>1432</td><td>1497</td><td>1697</td></tr> <tr><td>1212</td><td>1262</td><td>1297</td><td>1342</td><td>1392</td><td>1457</td><td>1537</td><td>1447</td><td>1512</td><td>1712</td></tr> </tbody> </table>	A	B/COM	C	D	E	F	G	L3/COL	L4	L5	1072	1122	1157	1202	1252	1317	1397	1307	1372	1572	1177	1227	1262	1307	1357	1422	1502	1412	1477	1677	1187	1237	1272	1317	1367	1432	1512	1422	1487	1687	1182	1232	1267	1312	1362	1427	1507	1417	1482	1682	1307	1357	1392	1437	1487	1552	1632	1542	1607	1807	1197	1247	1282	1327	1377	1442	1522	1432	1497	1697	1212	1262	1297	1342	1392	1457	1537	1447	1512	1712	<ul style="list-style-type: none"> • Height-adjustable 20" diameter foot ring • Infinite back angle adjustment with free float • 360° swivel • Pneumatic cylinder height adjustment 	WIDTH: 25.0 DEPTH: 26.0 HEIGHT: 48.5-61.0 SEAT WIDTH: 20.0 SEAT DEPTH: 19.0 SEAT HEIGHT: 28.0-38.0 BACK WIDTH: 20.0 BACK HEIGHT: 19.0-21.5 COM: 1.4 YD COL: 33.0 SQ FT WEIGHT: 42.0 LB	A8B/S \$105 Height Adjustable Arm A8B - Black A8S - Silver	A9B/S \$115 Height/Width Adjustable Arm A9B - Black A9S - Silver	C6 STD Large Diameter Carpet Casters
A	B/COM		C	D	E	F	G	L3/COL	L4	L5																																																																															
1072	1122	1157	1202	1252	1317	1397	1307	1372	1572																																																																																
1177	1227	1262	1307	1357	1422	1502	1412	1477	1677																																																																																
1187	1237	1272	1317	1367	1432	1512	1422	1487	1687																																																																																
1182	1232	1267	1312	1362	1427	1507	1417	1482	1682																																																																																
1307	1357	1392	1437	1487	1552	1632	1542	1607	1807																																																																																
1197	1247	1282	1327	1377	1442	1522	1432	1497	1697																																																																																
1212	1262	1297	1342	1392	1457	1537	1447	1512	1712																																																																																
			A8B/S				A10 \$110 Soft Touch C-Shaped Arm	A19 \$235 Polished Aluminum C-Shape Arm	C6S \$35 Large Diameter Hard Floor and Carpet Casters																																																																																
2368	P1	MID-BACK 8" STOOL POSTURE BACK Use for work surfaces up to 36" high	A00	<table border="1"> <thead> <tr> <th>A</th> <th>B/COM</th> <th>C</th> <th>D</th> <th>E</th> <th>F</th> <th>G</th> <th>L3/COL</th> <th>L4</th> <th>L5</th> </tr> </thead> <tbody> <tr><td>1072</td><td>1122</td><td>1157</td><td>1202</td><td>1252</td><td>1317</td><td>1397</td><td>1307</td><td>1372</td><td>1572</td></tr> <tr><td>1177</td><td>1227</td><td>1262</td><td>1307</td><td>1357</td><td>1422</td><td>1502</td><td>1412</td><td>1477</td><td>1677</td></tr> <tr><td>1187</td><td>1237</td><td>1272</td><td>1317</td><td>1367</td><td>1432</td><td>1512</td><td>1422</td><td>1487</td><td>1687</td></tr> <tr><td>1182</td><td>1232</td><td>1267</td><td>1312</td><td>1362</td><td>1427</td><td>1507</td><td>1417</td><td>1482</td><td>1682</td></tr> <tr><td>1307</td><td>1357</td><td>1392</td><td>1437</td><td>1487</td><td>1552</td><td>1632</td><td>1542</td><td>1607</td><td>1807</td></tr> <tr><td>1197</td><td>1247</td><td>1282</td><td>1327</td><td>1377</td><td>1442</td><td>1522</td><td>1432</td><td>1497</td><td>1697</td></tr> <tr><td>1212</td><td>1262</td><td>1297</td><td>1342</td><td>1392</td><td>1457</td><td>1537</td><td>1447</td><td>1512</td><td>1712</td></tr> </tbody> </table>	A	B/COM	C	D	E	F	G	L3/COL	L4	L5	1072	1122	1157	1202	1252	1317	1397	1307	1372	1572	1177	1227	1262	1307	1357	1422	1502	1412	1477	1677	1187	1237	1272	1317	1367	1432	1512	1422	1487	1687	1182	1232	1267	1312	1362	1427	1507	1417	1482	1682	1307	1357	1392	1437	1487	1552	1632	1542	1607	1807	1197	1247	1282	1327	1377	1442	1522	1432	1497	1697	1212	1262	1297	1342	1392	1457	1537	1447	1512	1712	<ul style="list-style-type: none"> • Height-adjustable 20" diameter foot ring • Infinite back angle adjustment with free float • 360° swivel • Pneumatic cylinder height adjustment 	WIDTH: 25.0 DEPTH: 26.0 HEIGHT: 44.5-55.0 SEAT WIDTH: 20.0 SEAT DEPTH: 19.0 SEAT HEIGHT: 24.0-32.0 BACK WIDTH: 20.0 BACK HEIGHT: 19.0-21.5 COM: 1.4 YD COL: 33.0 SQ FT WEIGHT: 43.0 LB	A36 \$125 Height Adjustable Pivot/Slide Arm	A37 \$140 Height/Width Adjustable Pivot/Slide Arm	C7 \$35 Chrome-Accented Hard Floor and Carpet Casters (Standard with Polished Base)
A	B/COM		C	D	E	F	G	L3/COL	L4	L5																																																																															
1072	1122	1157	1202	1252	1317	1397	1307	1372	1572																																																																																
1177	1227	1262	1307	1357	1422	1502	1412	1477	1677																																																																																
1187	1237	1272	1317	1367	1432	1512	1422	1487	1687																																																																																
1182	1232	1267	1312	1362	1427	1507	1417	1482	1682																																																																																
1307	1357	1392	1437	1487	1552	1632	1542	1607	1807																																																																																
1197	1247	1282	1327	1377	1442	1522	1432	1497	1697																																																																																
1212	1262	1297	1342	1392	1457	1537	1447	1512	1712																																																																																
			A8B/S																																																																																						

bristol

seamless integration into your office's architecture

HIGH-BACK

GSA SIN # 33721

- Task, stool, conference and executive seating
- Ratchet back lumbar height adjustment
- Ballistic nylon optional
- Warranted to 300 lbs.



CREATING BRISTOL MODEL NUMBER



PACKAGING NOTES

CODE	DESCRIPTION	LIST UPCHARGE
AB	ASSEMBLED IN BAG	\$0
PAC	PARTIALLY ASSEMBLED IN CARTON	\$0
BAC	BACK ASSEMBLED IN CARTON	\$80

MODEL	CONTROL	DESCRIPTION	ARM	FABRIC/LEATHER											FEATURES	DIMENSIONS	ARM OPTIONS	CASTER OPTIONS
				A	B/COM	C	D	E	F	G	L3/COL	L4	L5					
2380	S2	HIGH-BACK SWIVEL TILT	A00	1007	1062	1102	1147	1212	1267	1357	1262	1317	1532	<ul style="list-style-type: none"> • Upright lock • Center knob tension adjustment • 360° swivel • Pneumatic cylinder height adjustment 	WIDTH: 25.0 DEPTH: 26.0 HEIGHT: 40.5-48.5 SEAT WIDTH: 20.0 SEAT DEPTH: 19.0 SEAT HEIGHT: 16.5-21.0 SEAT HEIGHT W/ SEAT SLIDER: 18-22.5 BACK WIDTH: 20.0 BACK HEIGHT: 23.0-25.5 COM: 1.5 YD COL: 35.0 SQ FT WEIGHT: 31.0 LB	 A8B/S \$105 Height Adjustable Arm A8B - Black A8S - Silver	 A9B/S \$115 Height/Width Adjustable Arm A9B - Black A9S - Silver	 C6 STD Large Diameter Carpet Casters
	A8B/S		1112	1167	1207	1252	1317	1372	1462	1367	1422	1637						
	A9B/S		1122	1177	1217	1262	1327	1382	1472	1377	1432	1647						
	A10		1117	1172	1212	1257	1322	1377	1467	1372	1427	1642						
	A19		1242	1297	1337	1382	1447	1502	1592	1497	1552	1767						
	A36		1132	1187	1227	1272	1337	1392	1482	1387	1442	1657						
	A37		1147	1202	1242	1287	1352	1407	1497	1402	1457	1672						
				SEAT SLIDER (SS) - ADD \$60 - FACTORY INSTALLED														
2380	R1	HIGH-BACK ROCKING TILT	A00	1057	1112	1152	1197	1262	1317	1407	1312	1367	1582	<ul style="list-style-type: none"> • Infinite back angle adjustment • Infinite tilt lock • Center knob tension adjustment • 360° swivel • Pneumatic cylinder height adjustment 	WIDTH: 25.0 DEPTH: 26.0 HEIGHT: 41.5-48.5 SEAT WIDTH: 20.0 SEAT DEPTH: 19.0 SEAT HEIGHT: 17.5-22.0 SEAT HEIGHT W/ SEAT SLIDER: 18-22.5 BACK WIDTH: 20.0 BACK HEIGHT: 23.0-25.5 COM: 1.5 YD COL: 35.0 SQ FT WEIGHT: 36.0 LB	 A10 \$110 Soft Touch C-Shaped Arm	 A19 \$235 Polished Aluminum C-Shape Arm	 C6S \$35 Large Diameter Hard Floor and Carpet Casters
	A8B/S		1162	1217	1257	1302	1367	1422	1512	1417	1472	1687						
	A9B/S		1172	1227	1267	1312	1377	1432	1522	1427	1482	1697						
	A10		1167	1222	1262	1307	1372	1427	1517	1422	1477	1692						
	A19		1292	1347	1387	1432	1497	1552	1642	1547	1602	1817						
	A36		1182	1237	1277	1322	1387	1442	1532	1437	1492	1707						
	A37		1197	1252	1292	1337	1402	1457	1547	1452	1507	1722						
				SEAT SLIDER (SS) - ADD \$60 - FACTORY INSTALLED														
2380	Y2	HIGH-BACK HEAVY DUTY SYNCHRO TILT	A00	1087	1142	1182	1227	1292	1347	1437	1342	1397	1612	<ul style="list-style-type: none"> • 4-position tilt lock • Side knob tension adjustment • 2:1 back-to-seat tilt ratio • 360° swivel • Pneumatic cylinder height adjustment 	WIDTH: 25.0 DEPTH: 26.0 HEIGHT: 41.5-48.5 SEAT WIDTH: 20.0 SEAT DEPTH: 19.0 SEAT HEIGHT: 17.5-22.0 SEAT HEIGHT W/ SEAT SLIDER: 18-22.5 BACK WIDTH: 20.0 BACK HEIGHT: 23.0-25.5 COM: 1.5 YD COL: 35.0 SQ FT WEIGHT: 38.0 LB	 BA11B STD 27" Mid-Profile Nylon Base BA11B - Black	 BA12B/P/S \$110 27" Mid-Profile Aluminum Base BA12B - Black Powder Coat BA12P - Polished BA12S - Silver Powder Coat (C7 Chrome-Accented Casters Standard with Polished Base)	
	A8B/S		1192	1247	1287	1332	1397	1452	1542	1447	1502	1717						
	A9B/S		1202	1257	1297	1342	1407	1462	1552	1457	1512	1727						
	A10		1197	1252	1292	1337	1402	1457	1547	1452	1507	1722						
	A19		1322	1377	1417	1462	1527	1582	1672	1577	1632	1847						
	A36		1212	1267	1307	1352	1417	1472	1562	1467	1522	1737						
	A37		1227	1282	1322	1367	1432	1487	1577	1482	1537	1752						
				SEAT SLIDER (SS) - ADD \$60 - FACTORY INSTALLED														
2380	M1	HIGH-BACK MULTI-FUNCTION	A00	1107	1162	1202	1247	1312	1367	1457	1362	1417	1632	<ul style="list-style-type: none"> • Infinite back angle adjustment • 6° forward tilt • Center knob tension adjustment • 360° swivel • Pneumatic cylinder height adjustment 	WIDTH: 25.0 DEPTH: 26.0 HEIGHT: 41.5-48.5 SEAT WIDTH: 20.0 SEAT DEPTH: 19.0 SEAT HEIGHT: 17.5-22.0 SEAT HEIGHT W/ SEAT SLIDER: 18-22.5 BACK WIDTH: 20.0 BACK HEIGHT: 23.0-25.5 COM: 1.5 YD COL: 35.0 SQ FT WEIGHT: 40.0 LB	 SS \$60 Seat Slider 2.5" Side Paddle Activated	 BN1 \$35 Upholstered Outer Back in Black Ballistic Nylon BN1 - with Grade A Only BN2 - with Grade B and Up	 HD \$125 Heavy Duty Multi-Shift Upgrade to 350 lb. Includes BA12 High Profile Aluminum Base (Y2 Control only)
	A8B/S		1212	1267	1307	1352	1417	1472	1562	1467	1522	1737						
	A9B/S		1222	1277	1317	1362	1427	1482	1572	1477	1532	1747						
	A10		1217	1272	1312	1357	1422	1477	1567	1472	1527	1742						
	A19		1342	1397	1437	1482	1547	1602	1692	1597	1652	1867						
	A36		1232	1287	1327	1372	1437	1492	1582	1487	1542	1757						
	A37		1247	1302	1342	1387	1452	1507	1597	1502	1557	1772						
				SEAT SLIDER (SS) - ADD \$60 - FACTORY INSTALLED														

cavo

simply smart design. anywhere.

GSA SIN # 33721 PENDING

- Multipurpose seating including stacking, side, stools and bariatric
- Modern, elegant and simple design
- All plastic, upholstered seat or fully upholstered
- Wall-saver frame design
- Warranted to 350 lbs.



CREATING CAVO MODEL NUMBER

MODEL NUMBER CONTROL ARMS FRAME COLOR UPHOLSTERY PLASTIC PACKAGING OPTIONS

1 9 1 - - - - - A - - - - - F - A P - P - - - - - A - - - - -

* FOR ARMLESS USE CODE ADD

PACKAGING NOTES

CODE	DESCRIPTION	LIST UPCHARGE
AB	ASSEMBLED IN BAG	\$0
AC	BACK ASSEMBLED IN CARTON	\$0

CAVO CHAIRS SHIP UP TO 3 PER CARTON

ALL PLASTIC - AP - GUEST AND STOOL

MODEL	CONTROL	DESCRIPTION	ARM	PLASTIC	FEATURES	DIMENSIONS																				
1910	GT	PLASTIC BACK & PLASTIC SEAT GUEST STACKING - AP	A00	P 390	<ul style="list-style-type: none"> • Stacks 4 high on the floor • Stacks 10 high on the optional dolly • Wall-saver frame • Non-marring floor glides 	<table border="1"> <thead> <tr> <th>ARMLESS</th> <th>W/ ARMS</th> </tr> </thead> <tbody> <tr><td>WIDTH:</td><td>22.0 / 26.0</td></tr> <tr><td>DEPTH:</td><td>25.0 / 25.0</td></tr> <tr><td>HEIGHT:</td><td>35.0 / 35.0</td></tr> <tr><td>SEAT WIDTH:</td><td>18.5 / 18.5</td></tr> <tr><td>SEAT DEPTH:</td><td>17.7 / 17.7</td></tr> <tr><td>SEAT HEIGHT:</td><td>17.7 / 17.7</td></tr> <tr><td>BACK WIDTH:</td><td>20.0 / 20.0</td></tr> <tr><td>BACK HEIGHT:</td><td>17.0 / 17.0</td></tr> <tr><td>WEIGHT:</td><td>19.5 LB / 21.5 LB</td></tr> </tbody> </table>	ARMLESS	W/ ARMS	WIDTH:	22.0 / 26.0	DEPTH:	25.0 / 25.0	HEIGHT:	35.0 / 35.0	SEAT WIDTH:	18.5 / 18.5	SEAT DEPTH:	17.7 / 17.7	SEAT HEIGHT:	17.7 / 17.7	BACK WIDTH:	20.0 / 20.0	BACK HEIGHT:	17.0 / 17.0	WEIGHT:	19.5 LB / 21.5 LB
ARMLESS	W/ ARMS																									
WIDTH:	22.0 / 26.0																									
DEPTH:	25.0 / 25.0																									
HEIGHT:	35.0 / 35.0																									
SEAT WIDTH:	18.5 / 18.5																									
SEAT DEPTH:	17.7 / 17.7																									
SEAT HEIGHT:	17.7 / 17.7																									
BACK WIDTH:	20.0 / 20.0																									
BACK HEIGHT:	17.0 / 17.0																									
WEIGHT:	19.5 LB / 21.5 LB																									
		A55	P 450																							
1910	GT	PLASTIC BACK & PLASTIC SEAT GUEST STACKING WITH CASTERS - AP	A00	P 435	<ul style="list-style-type: none"> • 50mm casters for hard and carpet floors • Stacks 4 high on the floor • Stacks 10 high on the optional dolly • Wall-saver frame • Non-marring floor glides 	<table border="1"> <thead> <tr> <th>ARMLESS</th> <th>W/ ARMS</th> </tr> </thead> <tbody> <tr><td>WIDTH:</td><td>22.0 / 26.0</td></tr> <tr><td>DEPTH:</td><td>25.0 / 25.0</td></tr> <tr><td>HEIGHT:</td><td>35.0 / 35.0</td></tr> <tr><td>SEAT WIDTH:</td><td>18.5 / 18.5</td></tr> <tr><td>SEAT DEPTH:</td><td>17.7 / 17.7</td></tr> <tr><td>SEAT HEIGHT:</td><td>17.7 / 17.7</td></tr> <tr><td>BACK WIDTH:</td><td>20.0 / 20.0</td></tr> <tr><td>BACK HEIGHT:</td><td>17.0 / 17.0</td></tr> <tr><td>WEIGHT:</td><td>19.5 LB / 21.5 LB</td></tr> </tbody> </table>	ARMLESS	W/ ARMS	WIDTH:	22.0 / 26.0	DEPTH:	25.0 / 25.0	HEIGHT:	35.0 / 35.0	SEAT WIDTH:	18.5 / 18.5	SEAT DEPTH:	17.7 / 17.7	SEAT HEIGHT:	17.7 / 17.7	BACK WIDTH:	20.0 / 20.0	BACK HEIGHT:	17.0 / 17.0	WEIGHT:	19.5 LB / 21.5 LB
ARMLESS	W/ ARMS																									
WIDTH:	22.0 / 26.0																									
DEPTH:	25.0 / 25.0																									
HEIGHT:	35.0 / 35.0																									
SEAT WIDTH:	18.5 / 18.5																									
SEAT DEPTH:	17.7 / 17.7																									
SEAT HEIGHT:	17.7 / 17.7																									
BACK WIDTH:	20.0 / 20.0																									
BACK HEIGHT:	17.0 / 17.0																									
WEIGHT:	19.5 LB / 21.5 LB																									
		A55	P 495																							
1910	ST24	PLASTIC BACK & PLASTIC SEAT 24" COUNTER STOOL - AP	A00	P 520	<ul style="list-style-type: none"> • Counter height stool • Non-marring floor glides • Foot rest 	<table border="1"> <thead> <tr> <th>ARMLESS</th> <th>W/ ARMS</th> </tr> </thead> <tbody> <tr><td>WIDTH:</td><td>23.5 / 26.0</td></tr> <tr><td>DEPTH:</td><td>25.0 / 25.0</td></tr> <tr><td>HEIGHT:</td><td>38.5 / 38.5</td></tr> <tr><td>SEAT WIDTH:</td><td>18.5 / 18.5</td></tr> <tr><td>SEAT DEPTH:</td><td>17.7 / 17.7</td></tr> <tr><td>SEAT HEIGHT:</td><td>21.5 / 21.5</td></tr> <tr><td>BACK WIDTH:</td><td>20.0 / 20.0</td></tr> <tr><td>BACK HEIGHT:</td><td>17.0 / 17.0</td></tr> <tr><td>WEIGHT:</td><td>20.5 LB / 22.5 LB</td></tr> </tbody> </table>	ARMLESS	W/ ARMS	WIDTH:	23.5 / 26.0	DEPTH:	25.0 / 25.0	HEIGHT:	38.5 / 38.5	SEAT WIDTH:	18.5 / 18.5	SEAT DEPTH:	17.7 / 17.7	SEAT HEIGHT:	21.5 / 21.5	BACK WIDTH:	20.0 / 20.0	BACK HEIGHT:	17.0 / 17.0	WEIGHT:	20.5 LB / 22.5 LB
ARMLESS	W/ ARMS																									
WIDTH:	23.5 / 26.0																									
DEPTH:	25.0 / 25.0																									
HEIGHT:	38.5 / 38.5																									
SEAT WIDTH:	18.5 / 18.5																									
SEAT DEPTH:	17.7 / 17.7																									
SEAT HEIGHT:	21.5 / 21.5																									
BACK WIDTH:	20.0 / 20.0																									
BACK HEIGHT:	17.0 / 17.0																									
WEIGHT:	20.5 LB / 22.5 LB																									
		A55	P 580																							
1910	ST30	PLASTIC BACK & PLASTIC SEAT 30" BAR STOOL - AP	A00	P 540	<ul style="list-style-type: none"> • Bar height stool • Non-marring floor glides • Foot rest 	<table border="1"> <thead> <tr> <th>ARMLESS</th> <th>W/ ARMS</th> </tr> </thead> <tbody> <tr><td>WIDTH:</td><td>23.5 / 26.0</td></tr> <tr><td>DEPTH:</td><td>25.0 / 25.0</td></tr> <tr><td>HEIGHT:</td><td>44.0 / 44.0</td></tr> <tr><td>SEAT WIDTH:</td><td>18.5 / 18.5</td></tr> <tr><td>SEAT DEPTH:</td><td>17.7 / 17.7</td></tr> <tr><td>SEAT HEIGHT:</td><td>27.0 / 27.0</td></tr> <tr><td>BACK WIDTH:</td><td>20.0 / 20.0</td></tr> <tr><td>BACK HEIGHT:</td><td>17.0 / 17.0</td></tr> <tr><td>WEIGHT:</td><td>22.0 LB / 24.0 LB</td></tr> </tbody> </table>	ARMLESS	W/ ARMS	WIDTH:	23.5 / 26.0	DEPTH:	25.0 / 25.0	HEIGHT:	44.0 / 44.0	SEAT WIDTH:	18.5 / 18.5	SEAT DEPTH:	17.7 / 17.7	SEAT HEIGHT:	27.0 / 27.0	BACK WIDTH:	20.0 / 20.0	BACK HEIGHT:	17.0 / 17.0	WEIGHT:	22.0 LB / 24.0 LB
ARMLESS	W/ ARMS																									
WIDTH:	23.5 / 26.0																									
DEPTH:	25.0 / 25.0																									
HEIGHT:	44.0 / 44.0																									
SEAT WIDTH:	18.5 / 18.5																									
SEAT DEPTH:	17.7 / 17.7																									
SEAT HEIGHT:	27.0 / 27.0																									
BACK WIDTH:	20.0 / 20.0																									
BACK HEIGHT:	17.0 / 17.0																									
WEIGHT:	22.0 LB / 24.0 LB																									
		A55	P 600																							

CAUTION: Careless stacking of chairs may scratch and damage frames.

ARM OPTIONS

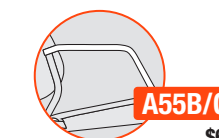

A55B/G
Soft Touch Polyurethane Arm
A55B - Black
A55G - Gray

ADDITIONAL OPTIONS



G21B/G
Tapered Plastic Glide
G21B - Black
G21G - Gray



G21BS/GS
Swivel Steel Glide
G21BS - Black Steel
G21GS - Gray Steel



G21BN/GN
Swivel Nylon Glide
G21BN - Black Nylon
G21GN - Gray Nylon



G21BF/GF
Swivel Felt Glide
G21BF - Black Felt
G21GF - Gray Felt

CASTER OPTIONS



C12S
Hard Floor and Carpet Casters

ACCESSORIES



GC9
Ganging Clip-2 per set
Arm-to-Arm and Armless-to-Armless



DL5
Stacking Dolly
Stacks up to 10 High Armless and 4 High Armed

FRAME COLORS

BLACK BF	SILVER SF
-------------	--------------

PLASTIC COLORS

BLACK SWAN P01	WHITE WHISPER P05	FEDERAL BLUE P11	CRIMSON RED P12	LEMON YELLOW P13	DOVE GRAY P14
CLOUD GRAY P15	LAGOON BLUE P16	APPLE GREEN P17	TANGERINE ORANGE P18	LATTE P19	AZURE BLUE P20

(BACK AND SEAT)

cavo

simply smart design. anywhere.

GSA SIN # 33721 PENDING

- Multipurpose seating including stacking, side, stools and bariatric
- Modern, elegant and simple design
- All plastic, upholstered seat or fully upholstered
- Wall-saver frame design
- Warranted to 350 lbs.



CREATING CAVO MODEL NUMBER



PACKAGING NOTES

CODE	DESCRIPTION	LIST UPCHARGE
AB	ASSEMBLED IN BAG	\$0
AC	ASSEMBLED IN CARTON	\$0

CAVO CHAIRS SHIP UP TO 3 PER CARTON

UPHOLSTERED SEAT - US - GUEST AND STOOL

MODEL	CONTROL	DESCRIPTION	ARM	FABRIC	FEATURES	DIMENSIONS	ARM OPTIONS	CASTER OPTIONS	ACCESSORIES																																																																																									
										A	B/COM	C	D	E	F	G	L3/COL	L4	L5																																																																															
1910	GT	PLASTIC BACK & UPHOLSTERED SEAT GUEST STACKING - US	A00	430	455	483	517	575	630	663	620	565	595	<ul style="list-style-type: none"> • Stacks 4 high on the floor • Stacks 10 high on the optional dolly • Wall-saver frame • Non-marring floor glides 	ARMLESS W/ ARMS WIDTH: 22.0 26.0 DEPTH: 25.0 25.0 HEIGHT: 35.0 35.0 SEAT WIDTH: 18.5 18.5 SEAT DEPTH: 17.7 17.7 SEAT HEIGHT: 18.5 18.5 BACK WIDTH: 20.0 20.5 BACK HEIGHT: 17.0 17.0 COM: 0.8 YD 0.8 YD COL: 7.65 SQ FT 7.65 SQ FT WEIGHT: 23.0 LB 25.0 LB	<p>A55B/G \$60</p> <p>Soft Touch Polyurethane Arm A55B - Black A55G - Gray</p>	<p>C12S STD</p> <p>Hard Floor and Carpet Casters</p>	<p>GC9 \$30</p> <p>Ganging Clip-2 per set Arm-to-Arm and Armless-to-Armless</p>																																																																																
			A55	490	515	543	577	635	690	723	680	625	655						1910	GT	PLASTIC BACK & UPHOLSTERED SEAT GUEST STACKING WITH CASTER - US	A00	475	500	528	562	620	675	708	665	610	640	<ul style="list-style-type: none"> • 50mm casters for hard and carpet floors • Stacks 4 high on the floor • Stacks 10 high on the optional dolly • Wall-saver frame • Non-marring floor glides 	ARMLESS W/ ARMS WIDTH: 22.0 26.0 DEPTH: 25.0 25.0 HEIGHT: 35.0 35.0 SEAT WIDTH: 18.5 18.5 SEAT DEPTH: 17.7 17.7 SEAT HEIGHT: 18.5 18.5 BACK WIDTH: 20.0 20.0 BACK HEIGHT: 17.0 17.0 COM: 0.8 YD 0.8 YD COL: 7.65 SQ FT 7.65 SQ FT WEIGHT: 23.0 LB 25.0 LB	<p>G21B/G NC</p> <p>Tapered Plastic Glide G21B - Black G21G - Gray</p>	<p>G21BN/GN \$20</p> <p>Swivel Nylon Glide G21BN - Black Nylon G21GN - Gray Nylon</p>	<p>DL5 \$399</p> <p>Stacking Dolly Stacks up to 10 High*</p>	A55	535	560	588	622	680	735	768	725	670	700	1910	ST24	PLASTIC BACK & UPHOLSTERED SEAT 24" COUNTER STOOL - US	A00	560	585	613	647	705	760	793	750	695	725	<ul style="list-style-type: none"> • Counter height stool • Non-marring floor glides • Foot rest 	ARMLESS W/ ARMS WIDTH: 23.5 26.0 DEPTH: 25.0 25.0 HEIGHT: 38.5 38.5 SEAT WIDTH: 18.5 18.5 SEAT DEPTH: 17.7 17.7 SEAT HEIGHT: 22.0 22.0 BACK WIDTH: 20.0 20.0 BACK HEIGHT: 17.0 17.0 COM: 0.8 YD 0.8 YD COL: 7.65 SQ FT 7.65 SQ FT WEIGHT: 24.0 LB 26.0 LB	<p>G21BS/GS \$20</p> <p>Swivel Steel Glide G21BS - Black Steel G21GS - Gray Steel</p>	<p>G21BF/GF \$20</p> <p>Swivel Felt Glide G21BF - Black Felt G21GF - Gray Felt</p>	<p>BLACK BF SILVER SF</p>	A55	620	645	673	707	765	820	853	810	755	785	1910	ST30	PLASTIC BACK & UPHOLSTERED SEAT 30" BAR STOOL - US	A00	580	605	633	667	725	780	813	770	715	745	<ul style="list-style-type: none"> • Bar height stool • Non-marring floor glides • Foot rest 	ARMLESS W/ ARMS WIDTH: 23.5 26.0 DEPTH: 25.0 25.0 HEIGHT: 44.0 44.5 SEAT WIDTH: 18.5 18.5 SEAT DEPTH: 17.7 18.0 SEAT HEIGHT: 28.0 28.0 BACK WIDTH: 20.0 20.0 BACK HEIGHT: 17.0 17.0 COM: 0.8 YD 0.8 YD COL: 7.65 SQ FT 7.65 SQ FT WEIGHT: 25.5 LB 28.0 LB	<p>BLACK SWAN P01 WHITE WHISPER P05 FEDERAL BLUE P11 CRIMSON RED P12 LEMON YELLOW P13 DOVE GRAY P14 CLOUD GRAY P15 LAGOON BLUE P16 APPLE GREEN P17 TANGERINE ORANGE P18 LATTE P19 AZURE BLUE P20</p>	A55	640	665
1910	GT	PLASTIC BACK & UPHOLSTERED SEAT GUEST STACKING WITH CASTER - US	A00	475	500	528	562	620	675	708	665	610	640	<ul style="list-style-type: none"> • 50mm casters for hard and carpet floors • Stacks 4 high on the floor • Stacks 10 high on the optional dolly • Wall-saver frame • Non-marring floor glides 	ARMLESS W/ ARMS WIDTH: 22.0 26.0 DEPTH: 25.0 25.0 HEIGHT: 35.0 35.0 SEAT WIDTH: 18.5 18.5 SEAT DEPTH: 17.7 17.7 SEAT HEIGHT: 18.5 18.5 BACK WIDTH: 20.0 20.0 BACK HEIGHT: 17.0 17.0 COM: 0.8 YD 0.8 YD COL: 7.65 SQ FT 7.65 SQ FT WEIGHT: 23.0 LB 25.0 LB	<p>G21B/G NC</p> <p>Tapered Plastic Glide G21B - Black G21G - Gray</p>	<p>G21BN/GN \$20</p> <p>Swivel Nylon Glide G21BN - Black Nylon G21GN - Gray Nylon</p>	<p>DL5 \$399</p> <p>Stacking Dolly Stacks up to 10 High*</p>																																																																																
			A55	535	560	588	622	680	735	768	725	670	700						1910	ST24	PLASTIC BACK & UPHOLSTERED SEAT 24" COUNTER STOOL - US	A00	560	585	613	647	705	760	793	750	695	725	<ul style="list-style-type: none"> • Counter height stool • Non-marring floor glides • Foot rest 	ARMLESS W/ ARMS WIDTH: 23.5 26.0 DEPTH: 25.0 25.0 HEIGHT: 38.5 38.5 SEAT WIDTH: 18.5 18.5 SEAT DEPTH: 17.7 17.7 SEAT HEIGHT: 22.0 22.0 BACK WIDTH: 20.0 20.0 BACK HEIGHT: 17.0 17.0 COM: 0.8 YD 0.8 YD COL: 7.65 SQ FT 7.65 SQ FT WEIGHT: 24.0 LB 26.0 LB	<p>G21BS/GS \$20</p> <p>Swivel Steel Glide G21BS - Black Steel G21GS - Gray Steel</p>	<p>G21BF/GF \$20</p> <p>Swivel Felt Glide G21BF - Black Felt G21GF - Gray Felt</p>	<p>BLACK BF SILVER SF</p>	A55	620	645	673	707	765	820	853	810	755	785	1910	ST30	PLASTIC BACK & UPHOLSTERED SEAT 30" BAR STOOL - US	A00	580	605	633	667	725	780	813	770	715	745	<ul style="list-style-type: none"> • Bar height stool • Non-marring floor glides • Foot rest 	ARMLESS W/ ARMS WIDTH: 23.5 26.0 DEPTH: 25.0 25.0 HEIGHT: 44.0 44.5 SEAT WIDTH: 18.5 18.5 SEAT DEPTH: 17.7 18.0 SEAT HEIGHT: 28.0 28.0 BACK WIDTH: 20.0 20.0 BACK HEIGHT: 17.0 17.0 COM: 0.8 YD 0.8 YD COL: 7.65 SQ FT 7.65 SQ FT WEIGHT: 25.5 LB 28.0 LB	<p>BLACK SWAN P01 WHITE WHISPER P05 FEDERAL BLUE P11 CRIMSON RED P12 LEMON YELLOW P13 DOVE GRAY P14 CLOUD GRAY P15 LAGOON BLUE P16 APPLE GREEN P17 TANGERINE ORANGE P18 LATTE P19 AZURE BLUE P20</p>	A55	640	665	693	727	785	840	873	830	775	805																						
1910	ST24	PLASTIC BACK & UPHOLSTERED SEAT 24" COUNTER STOOL - US	A00	560	585	613	647	705	760	793	750	695	725	<ul style="list-style-type: none"> • Counter height stool • Non-marring floor glides • Foot rest 	ARMLESS W/ ARMS WIDTH: 23.5 26.0 DEPTH: 25.0 25.0 HEIGHT: 38.5 38.5 SEAT WIDTH: 18.5 18.5 SEAT DEPTH: 17.7 17.7 SEAT HEIGHT: 22.0 22.0 BACK WIDTH: 20.0 20.0 BACK HEIGHT: 17.0 17.0 COM: 0.8 YD 0.8 YD COL: 7.65 SQ FT 7.65 SQ FT WEIGHT: 24.0 LB 26.0 LB	<p>G21BS/GS \$20</p> <p>Swivel Steel Glide G21BS - Black Steel G21GS - Gray Steel</p>	<p>G21BF/GF \$20</p> <p>Swivel Felt Glide G21BF - Black Felt G21GF - Gray Felt</p>	<p>BLACK BF SILVER SF</p>																																																																																
			A55	620	645	673	707	765	820	853	810	755	785						1910	ST30	PLASTIC BACK & UPHOLSTERED SEAT 30" BAR STOOL - US	A00	580	605	633	667	725	780	813	770	715	745	<ul style="list-style-type: none"> • Bar height stool • Non-marring floor glides • Foot rest 	ARMLESS W/ ARMS WIDTH: 23.5 26.0 DEPTH: 25.0 25.0 HEIGHT: 44.0 44.5 SEAT WIDTH: 18.5 18.5 SEAT DEPTH: 17.7 18.0 SEAT HEIGHT: 28.0 28.0 BACK WIDTH: 20.0 20.0 BACK HEIGHT: 17.0 17.0 COM: 0.8 YD 0.8 YD COL: 7.65 SQ FT 7.65 SQ FT WEIGHT: 25.5 LB 28.0 LB	<p>BLACK SWAN P01 WHITE WHISPER P05 FEDERAL BLUE P11 CRIMSON RED P12 LEMON YELLOW P13 DOVE GRAY P14 CLOUD GRAY P15 LAGOON BLUE P16 APPLE GREEN P17 TANGERINE ORANGE P18 LATTE P19 AZURE BLUE P20</p>	A55	640	665	693	727	785	840	873	830	775	805																																																				
1910	ST30	PLASTIC BACK & UPHOLSTERED SEAT 30" BAR STOOL - US	A00	580	605	633	667	725	780	813	770	715	745	<ul style="list-style-type: none"> • Bar height stool • Non-marring floor glides • Foot rest 	ARMLESS W/ ARMS WIDTH: 23.5 26.0 DEPTH: 25.0 25.0 HEIGHT: 44.0 44.5 SEAT WIDTH: 18.5 18.5 SEAT DEPTH: 17.7 18.0 SEAT HEIGHT: 28.0 28.0 BACK WIDTH: 20.0 20.0 BACK HEIGHT: 17.0 17.0 COM: 0.8 YD 0.8 YD COL: 7.65 SQ FT 7.65 SQ FT WEIGHT: 25.5 LB 28.0 LB	<p>BLACK SWAN P01 WHITE WHISPER P05 FEDERAL BLUE P11 CRIMSON RED P12 LEMON YELLOW P13 DOVE GRAY P14 CLOUD GRAY P15 LAGOON BLUE P16 APPLE GREEN P17 TANGERINE ORANGE P18 LATTE P19 AZURE BLUE P20</p>																																																																																		
			A55	640	665	693	727	785	840	873	830	775	805																																																																																					

CAUTION: Careless stacking of chairs may scratch and damage frames.
 *Due to the nature of vinyl upholstery, stacking may cause impressions on the seat. 9to5 Seating does not warrant the effects of the stacking on vinyl upholstery.

cavo

simply smart design. anywhere.

GSA SIN # 33721 PENDING

- Multipurpose seating including stacking, side, stools and bariatric
- Modern, elegant and simple design
- All plastic, upholstered seat or fully upholstered
- Wall-saver frame design
- Warranted to 350 lbs.



CREATING CAVO MODEL NUMBER

MODEL NUMBER CONTROL ARMS GLIDES FRAME COLOR UPHOLSTERY GRADE PACKAGING OPTIONS

1 9 1 - - - - A - G 2 1 - - F - U P - - - - A - - - -

* FOR ARMLESS USE CODE A00

PACKAGING NOTES

CODE	DESCRIPTION	LIST UPCHARGE
AB	ASSEMBLED IN BAG	\$0
AC	ASSEMBLED IN CARTON	\$0

CAVO CHAIRS SHIP UP TO 3 PER CARTON

FULLY UPHOLSTERED - UP - GUEST AND STOOL

MODEL	CONTROL	DESCRIPTION	ARM	FABRIC	DIMENSIONS										FEATURES	DIMENSIONS	
					A	B/COM	C	D	E	F	G	L3/COL	L4	L5		ARMLESS	W/ ARMS
1910	GT	UPHOLSTERED BACK & SEAT GUEST STACKING - UP	A00		485	525	560	620	680	765	820	765	815	935	<ul style="list-style-type: none"> • Stacks 4 high on the floor • Stacks 10 high on the optional dolly • Wall-saver frame • Non-marring floor glides 	22.0	26.0
			A55		545	585	620	680	740	825	880	825	875	995		25.0	25.0
1910	GT	UPHOLSTERED BACK & SEAT GUEST STACKING WITH CASTERS - UP	A00		530	570	605	665	725	810	865	810	860	980	<ul style="list-style-type: none"> • 50mm casters for hard and carpet floors • Stacks 4 high on the floor • Stacks 10 high on the optional dolly • Wall-saver frame • Non-marring floor glides 	22.0	26.0
			A55		590	630	665	725	785	870	925	870	920	1040		25.0	25.0
1910	ST24	UPHOLSTERED BACK & SEAT 24" COUNTER STOOL - UP	A00		615	655	690	750	810	895	950	895	945	1065	<ul style="list-style-type: none"> • Counter height stool • Non-marring floor glides • Foot rest 	23.5	26.0
			A55		675	715	750	810	870	955	1010	955	1005	1125		25.0	25.0
1910	ST30	UPHOLSTERED BACK & SEAT 30" BAR STOOL - UP	A00		635	675	710	770	830	915	970	915	965	1085	<ul style="list-style-type: none"> • Bar height stool • Non-marring floor glides • Foot rest 	23.5	23.5
			A55		695	735	770	830	890	975	1030	975	1025	1145		25.0	25.0

ARM OPTIONS

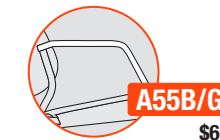

A55B/G
\$60
Soft Touch Polyurethane Arm
A55B - Black
A55G - Gray

ADDITIONAL OPTIONS



G21B/G
NC
Tapered Plastic Glide
G21B - Black
G21G - Gray



G21BS/GS
\$20
Swivel Steel Glide
G21BS - Black Steel
G21GS - Gray Steel



G21BN/GN
\$20
Swivel Nylon Glide
G21BN - Black Nylon
G21GN - Gray Nylon



G21BF/GF
\$20
Swivel Felt Glide
G21BF - Black Felt
G21GF - Gray Felt

CASTER OPTIONS



C12S
STD
Hard Floor and Carpet Casters

ACCESSORIES



GC9
\$30
Ganging Clip-2 per set
Arm-to-Arm and Armless-to-Armless



DL5
\$399
Stacking Dolly
Stacks up to 10 High*

FRAME COLORS



The color of the back cosmetic plastic cover coordinates with the frame color

CAUTION: Careless stacking of chairs may scratch and damage frames.
*Due to the nature of vinyl upholstery, stacking may cause impressions on the seat. 9to5 Seating does not warrant the effects of the stacking on vinyl upholstery.

cavo

simply smart design. anywhere.

GSA SIN # 33721 PENDING

- Multipurpose seating including stacking, side, stools and bariatric
- Modern, elegant and simple design
- All plastic, upholstered seat or fully upholstered
- Wall-saver frame design
- Warranted to 750 lbs.



CREATING CAVO MODEL NUMBER

MODEL NUMBER	CONTROL	FRAME COLOR	ARMS	GLIDES	UPHOLSTERY	GRADE	PACKAGING
191	GT	F	A55	G20	UP		

* FOR ARMLESS USE CODE A00

PACKAGING NOTES

CODE	DESCRIPTION	LIST UPCHARGE
AB	ASSEMBLED IN BAG	\$0
AC	ASSEMBLED IN CARTON	\$0

BARIATRIC UPHOLSTERED - UP - AVAILABLE IN MARCH 2024

MODEL	CONTROL	DESCRIPTION	ARM	FABRIC							FEATURES	DIMENSIONS
				A	B/COM	C	D	E	F	G		
1912	GT	UPHOLSTERED BACK & SEAT BARIATRIC - UP RATED TO 750 LBS	A55	979	1049	1094	1164	1244	1334	1434	<ul style="list-style-type: none"> • Steel reinforced seat and back • 30" wide seat • Does not stack • Warranted to 750 lbs. 	WIDTH: 36.0 DEPTH: 25.5 HEIGHT: 34.0 SEAT WIDTH: 29.5 SEAT DEPTH: 17.7 SEAT HEIGHT: 18.0 BACK WIDTH: 30.0 BACK HEIGHT: 17.0 COM: 2.8 YD COL: N/A WEIGHT: 32.0 LB

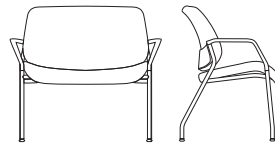

ARM OPTIONS

A55B/G
\$60
Soft Touch Polyurethane Arm
A55B - Black
A55G - Gray

ADDITIONAL OPTIONS

G20N
STD
Tapered Plastic Glide

G20S
\$20
Swivel Steel Glide

FRAME COLORS

BLACK BF	SILVER SF
-------------	--------------

Back cosmetic cover color matches frame color

CAUTION: Careless stacking of chairs may scratch and damage frames. Due to the nature of vinyl upholstery, stacking may cause impressions on the seat. 9to5 Seating does not warrant the effects of the stacking on vinyl upholstery.

clary

works well with others

GSA SIN # 33721

- Side and guest seating
- Mesh or upholstered back options
- Wall-saver frame
- Warranted to 300 lbs.



CREATING CLARY MODEL NUMBER

MODEL NUMBER CONTROL ARMS FRAME COLOR UPHOLSTERY PLASTIC MESH GRADE CASTERS PACKAGING OPTIONS

1 5 1 0 - G T - A [] [] [] - [] F - [] B - P [] [] - M [] [] - [] - C [] [] [] - [] [] [] [] [] []

* FOR ARMLESS USE CODE A00

PACKAGING NOTES

CODE	DESCRIPTION	LIST UPCHARGE
AB	ASSEMBLED IN BAG	\$0
AC	ASSEMBLED IN CARTON	\$0

CLARY CHAIRS SHIP UP TO 3 PER CARTON

MESH BACK (MB) & UPHOLSTERED BACK (UB)

MODEL	DESCRIPTION	ARM	FABRIC	FEATURES	DIMENSIONS																																																															
					ARMLESS	W/ ARMS																																																														
1510 GT	MESH BACK & UPHOLSTERED SEAT GUEST SIDE Mesh back with upholstered seat	A00 A49B/G	<table border="1"> <thead> <tr> <th>A</th><th>B/COM</th><th>C</th><th>D</th><th>E</th><th>F</th><th>G</th><th>L3/COL</th><th>L4</th><th>L5</th> </tr> </thead> <tbody> <tr> <td>449</td><td>477</td><td>504</td><td>534</td><td>564</td><td>609</td><td>649</td><td>609</td><td>659</td><td>729</td> </tr> <tr> <td>509</td><td>537</td><td>564</td><td>594</td><td>624</td><td>669</td><td>709</td><td>669</td><td>719</td><td>789</td> </tr> </tbody> </table>	A	B/COM	C	D	E	F	G	L3/COL	L4	L5	449	477	504	534	564	609	649	609	659	729	509	537	564	594	624	669	709	669	719	789	<ul style="list-style-type: none"> • Armless or fixed arms • Stacks armless 4 on the floor and 6 on a dolly • Stacks armed 4 on the floor and 5 on a dolly • Arms and glides coordinate with the frame color 	<table border="1"> <thead> <tr> <th>WIDTH:</th><td>19.0</td><td>22.5</td> </tr> <tr> <th>DEPTH:</th><td>23.5</td><td>23.5</td> </tr> <tr> <th>HEIGHT:</th><td>34.0</td><td>34.0</td> </tr> <tr> <th>SEAT WIDTH:</th><td>18.5</td><td>18.5</td> </tr> <tr> <th>SEAT DEPTH:</th><td>17.0</td><td>17.0</td> </tr> <tr> <th>SEAT HEIGHT:</th><td>18.5</td><td>18.5</td> </tr> <tr> <th>BACK WIDTH:</th><td>19.5</td><td>19.5</td> </tr> <tr> <th>BACK HEIGHT:</th><td>16.0</td><td>16.0</td> </tr> <tr> <th>COM:</th><td>1.0 YD</td><td>1.0 YD</td> </tr> <tr> <th>COL:</th><td>13 SQ FT</td><td>13 SQ FT</td> </tr> <tr> <th>WEIGHT:</th><td>15.5 LB</td><td>17.5 LB</td> </tr> </thead></table>	WIDTH:	19.0	22.5	DEPTH:	23.5	23.5	HEIGHT:	34.0	34.0	SEAT WIDTH:	18.5	18.5	SEAT DEPTH:	17.0	17.0	SEAT HEIGHT:	18.5	18.5	BACK WIDTH:	19.5	19.5	BACK HEIGHT:	16.0	16.0	COM:	1.0 YD	1.0 YD	COL:	13 SQ FT	13 SQ FT	WEIGHT:	15.5 LB	17.5 LB
A	B/COM	C	D	E	F	G	L3/COL	L4	L5																																																											
449	477	504	534	564	609	649	609	659	729																																																											
509	537	564	594	624	669	709	669	719	789																																																											
WIDTH:	19.0	22.5																																																																		
DEPTH:	23.5	23.5																																																																		
HEIGHT:	34.0	34.0																																																																		
SEAT WIDTH:	18.5	18.5																																																																		
SEAT DEPTH:	17.0	17.0																																																																		
SEAT HEIGHT:	18.5	18.5																																																																		
BACK WIDTH:	19.5	19.5																																																																		
BACK HEIGHT:	16.0	16.0																																																																		
COM:	1.0 YD	1.0 YD																																																																		
COL:	13 SQ FT	13 SQ FT																																																																		
WEIGHT:	15.5 LB	17.5 LB																																																																		
1510 GT	UPHOLSTERED BACK & UPHOLSTERED SEAT GUEST SIDE Upholstered back with upholstered seat	A00 A49B/G	<table border="1"> <thead> <tr> <th>A</th><th>B/COM</th><th>C</th><th>D</th><th>E</th><th>F</th><th>G</th><th>L3/COL</th><th>L4</th><th>L5</th> </tr> </thead> <tbody> <tr> <td>469</td><td>497</td><td>524</td><td>554</td><td>584</td><td>629</td><td>669</td><td>629</td><td>679</td><td>749</td> </tr> <tr> <td>529</td><td>557</td><td>584</td><td>614</td><td>644</td><td>689</td><td>729</td><td>689</td><td>739</td><td>809</td> </tr> </tbody> </table>	A	B/COM	C	D	E	F	G	L3/COL	L4	L5	469	497	524	554	584	629	669	629	679	749	529	557	584	614	644	689	729	689	739	809	<ul style="list-style-type: none"> • Armless or fixed arms • Stacks armless 4 on the floor and 6 on a dolly • Stacks armed 4 on the floor and 5 on a dolly • Arms and glides coordinate with the frame color 	<table border="1"> <thead> <tr> <th>WIDTH:</th><td>19.0</td><td>22.5</td> </tr> <tr> <th>DEPTH:</th><td>23.5</td><td>23.5</td> </tr> <tr> <th>HEIGHT:</th><td>34.0</td><td>34.0</td> </tr> <tr> <th>SEAT WIDTH:</th><td>18.5</td><td>18.5</td> </tr> <tr> <th>SEAT DEPTH:</th><td>17.0</td><td>17.0</td> </tr> <tr> <th>SEAT HEIGHT:</th><td>18.5</td><td>18.5</td> </tr> <tr> <th>BACK WIDTH:</th><td>19.5</td><td>19.5</td> </tr> <tr> <th>BACK HEIGHT:</th><td>16.0</td><td>16.0</td> </tr> <tr> <th>COM:</th><td>1.0 YD</td><td>1.0 YD</td> </tr> <tr> <th>COL:</th><td>14 SQ FT</td><td>14 SQ FT</td> </tr> <tr> <th>WEIGHT:</th><td>18.0 LB</td><td>20.0 LB</td> </tr> </thead></table>	WIDTH:	19.0	22.5	DEPTH:	23.5	23.5	HEIGHT:	34.0	34.0	SEAT WIDTH:	18.5	18.5	SEAT DEPTH:	17.0	17.0	SEAT HEIGHT:	18.5	18.5	BACK WIDTH:	19.5	19.5	BACK HEIGHT:	16.0	16.0	COM:	1.0 YD	1.0 YD	COL:	14 SQ FT	14 SQ FT	WEIGHT:	18.0 LB	20.0 LB
A	B/COM	C	D	E	F	G	L3/COL	L4	L5																																																											
469	497	524	554	584	629	669	629	679	749																																																											
529	557	584	614	644	689	729	689	739	809																																																											
WIDTH:	19.0	22.5																																																																		
DEPTH:	23.5	23.5																																																																		
HEIGHT:	34.0	34.0																																																																		
SEAT WIDTH:	18.5	18.5																																																																		
SEAT DEPTH:	17.0	17.0																																																																		
SEAT HEIGHT:	18.5	18.5																																																																		
BACK WIDTH:	19.5	19.5																																																																		
BACK HEIGHT:	16.0	16.0																																																																		
COM:	1.0 YD	1.0 YD																																																																		
COL:	14 SQ FT	14 SQ FT																																																																		
WEIGHT:	18.0 LB	20.0 LB																																																																		
1510 GT	MESH BACK & UPHOLSTERED SEAT GUEST SIDE WITH CASTERS Mesh back with upholstered seat	A00 A49B/G	<table border="1"> <thead> <tr> <th>A</th><th>B/COM</th><th>C</th><th>D</th><th>E</th><th>F</th><th>G</th><th>L3/COL</th><th>L4</th><th>L5</th> </tr> </thead> <tbody> <tr> <td>494</td><td>522</td><td>549</td><td>579</td><td>609</td><td>654</td><td>694</td><td>654</td><td>704</td><td>774</td> </tr> <tr> <td>554</td><td>582</td><td>609</td><td>639</td><td>669</td><td>714</td><td>754</td><td>714</td><td>764</td><td>834</td> </tr> </tbody> </table>	A	B/COM	C	D	E	F	G	L3/COL	L4	L5	494	522	549	579	609	654	694	654	704	774	554	582	609	639	669	714	754	714	764	834	<ul style="list-style-type: none"> • Armless or fixed arms • Arms coordinate with the frame color 	<table border="1"> <thead> <tr> <th>WIDTH:</th><td>19.0</td><td>22.5</td> </tr> <tr> <th>DEPTH:</th><td>23.5</td><td>23.5</td> </tr> <tr> <th>HEIGHT:</th><td>34.0</td><td>34.0</td> </tr> <tr> <th>SEAT WIDTH:</th><td>18.5</td><td>18.5</td> </tr> <tr> <th>SEAT DEPTH:</th><td>17.0</td><td>17.0</td> </tr> <tr> <th>SEAT HEIGHT:</th><td>18.5</td><td>18.5</td> </tr> <tr> <th>BACK WIDTH:</th><td>19.5</td><td>19.5</td> </tr> <tr> <th>BACK HEIGHT:</th><td>16.0</td><td>16.0</td> </tr> <tr> <th>COM:</th><td>1.0 YD</td><td>1.0 YD</td> </tr> <tr> <th>COL:</th><td>13 SQ FT</td><td>13 SQ FT</td> </tr> <tr> <th>WEIGHT:</th><td>15.5 LB</td><td>17.5 LB</td> </tr> </thead></table>	WIDTH:	19.0	22.5	DEPTH:	23.5	23.5	HEIGHT:	34.0	34.0	SEAT WIDTH:	18.5	18.5	SEAT DEPTH:	17.0	17.0	SEAT HEIGHT:	18.5	18.5	BACK WIDTH:	19.5	19.5	BACK HEIGHT:	16.0	16.0	COM:	1.0 YD	1.0 YD	COL:	13 SQ FT	13 SQ FT	WEIGHT:	15.5 LB	17.5 LB
A	B/COM	C	D	E	F	G	L3/COL	L4	L5																																																											
494	522	549	579	609	654	694	654	704	774																																																											
554	582	609	639	669	714	754	714	764	834																																																											
WIDTH:	19.0	22.5																																																																		
DEPTH:	23.5	23.5																																																																		
HEIGHT:	34.0	34.0																																																																		
SEAT WIDTH:	18.5	18.5																																																																		
SEAT DEPTH:	17.0	17.0																																																																		
SEAT HEIGHT:	18.5	18.5																																																																		
BACK WIDTH:	19.5	19.5																																																																		
BACK HEIGHT:	16.0	16.0																																																																		
COM:	1.0 YD	1.0 YD																																																																		
COL:	13 SQ FT	13 SQ FT																																																																		
WEIGHT:	15.5 LB	17.5 LB																																																																		
1510 GT	UPHOLSTERED BACK & UPHOLSTERED SEAT GUEST SIDE WITH CASTERS Upholstered back with upholstered seat	A00 A49B/G	<table border="1"> <thead> <tr> <th>A</th><th>B/COM</th><th>C</th><th>D</th><th>E</th><th>F</th><th>G</th><th>L3/COL</th><th>L4</th><th>L5</th> </tr> </thead> <tbody> <tr> <td>514</td><td>542</td><td>569</td><td>599</td><td>629</td><td>674</td><td>714</td><td>674</td><td>724</td><td>794</td> </tr> <tr> <td>574</td><td>602</td><td>629</td><td>659</td><td>689</td><td>734</td><td>774</td><td>734</td><td>784</td><td>854</td> </tr> </tbody> </table>	A	B/COM	C	D	E	F	G	L3/COL	L4	L5	514	542	569	599	629	674	714	674	724	794	574	602	629	659	689	734	774	734	784	854	<ul style="list-style-type: none"> • Armless or fixed arms • Arms coordinate with the frame color 	<table border="1"> <thead> <tr> <th>WIDTH:</th><td>19.0</td><td>22.5</td> </tr> <tr> <th>DEPTH:</th><td>23.5</td><td>23.5</td> </tr> <tr> <th>HEIGHT:</th><td>34.0</td><td>34.0</td> </tr> <tr> <th>SEAT WIDTH:</th><td>18.5</td><td>18.5</td> </tr> <tr> <th>SEAT DEPTH:</th><td>17.0</td><td>17.0</td> </tr> <tr> <th>SEAT HEIGHT:</th><td>18.5</td><td>18.5</td> </tr> <tr> <th>BACK WIDTH:</th><td>19.5</td><td>19.5</td> </tr> <tr> <th>BACK HEIGHT:</th><td>16.0</td><td>16.0</td> </tr> <tr> <th>COM:</th><td>1.0 YD</td><td>1.0 YD</td> </tr> <tr> <th>COL:</th><td>14 SQ FT</td><td>14 SQ FT</td> </tr> <tr> <th>WEIGHT:</th><td>18.0 LB</td><td>20.0 LB</td> </tr> </thead></table>	WIDTH:	19.0	22.5	DEPTH:	23.5	23.5	HEIGHT:	34.0	34.0	SEAT WIDTH:	18.5	18.5	SEAT DEPTH:	17.0	17.0	SEAT HEIGHT:	18.5	18.5	BACK WIDTH:	19.5	19.5	BACK HEIGHT:	16.0	16.0	COM:	1.0 YD	1.0 YD	COL:	14 SQ FT	14 SQ FT	WEIGHT:	18.0 LB	20.0 LB
A	B/COM	C	D	E	F	G	L3/COL	L4	L5																																																											
514	542	569	599	629	674	714	674	724	794																																																											
574	602	629	659	689	734	774	734	784	854																																																											
WIDTH:	19.0	22.5																																																																		
DEPTH:	23.5	23.5																																																																		
HEIGHT:	34.0	34.0																																																																		
SEAT WIDTH:	18.5	18.5																																																																		
SEAT DEPTH:	17.0	17.0																																																																		
SEAT HEIGHT:	18.5	18.5																																																																		
BACK WIDTH:	19.5	19.5																																																																		
BACK HEIGHT:	16.0	16.0																																																																		
COM:	1.0 YD	1.0 YD																																																																		
COL:	14 SQ FT	14 SQ FT																																																																		
WEIGHT:	18.0 LB	20.0 LB																																																																		

ARM OPTIONS

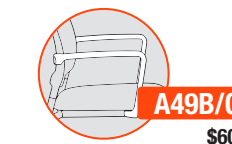

Nylon Fixed Arm
A49B - Black
A49G - Graphite Gray

ADDITIONAL OPTIONS



Tapered Plastic Glide
G19B - Black
G19G - Gray



Swivel Steel Glide
G19BS - Black Steel
G19GS - Gray Steel



Swivel Nylon Glide
G19BN - Black Nylon
G19GN - Gray Nylon



Swivel Felt Glide
G19BF - Black Felt
G19GF - Gray Felt

CASTER OPTIONS



Carpet Casters



Hard Floor and Carpet Casters



Stacking Dolly
Stacks armless 6 high
Stacks armed 5 high

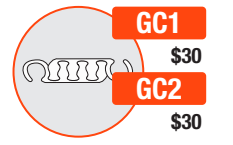

Ganging Clip - 2 per Set
GC1 - Armless-to-Armless
GC2 - Arm-to-Arm

FRAME COLORS

BLACK BF	SILVER SF
-------------	--------------

PLASTIC COLORS

BLACK PBK	GRAPHITE GRAY PGG
--------------	-------------------------

MESH COLORS

M1	BLACK M11	GRAY M12	SILVER M13			
M2	BLACK M21	GRAY M22	WHITE M23	GREEN M24	RED M25	
M2	BLUE M26	ORANGE M27	AQUA M28			
M3	GRAPHITE M31	SLATE M32	SNOW M33			
M4	LATTE M40	CLOUD M41	LEMON M42	APPLE M43	TANGERINE M44	CRIMSON M46
M4	ONYX M48	DOVE M49	AZURE M50	FEDERAL BLUE M51	WHITE WHISPER M52	

*9to5 Seating does not recommend stacking the Clary model with casters. Due to the nature of vinyl upholstery, stacking may cause impressions on the seat. 9to5 Seating does not warrant scratched frames or damage to upholstery due to the stacking of chairs.

core

contemporary lines for your workspace

GSA SIN # 33721

- Task, stool, conference and executive seating
- Poly outer back
- Ratchet back lumbar height adjustment
- Molded foam back over mesh suspension
- Hubless casters standard
- Warranted to 300 lbs.



CREATING CORE MODEL NUMBER

MODEL NUMBER CONTROL ARMS PLASTIC COLOR GRADE BASE CASTERS PACKAGING OPTIONS

2 2 6 [] [] [] - [] [] [] - A [] [] [] - P B K - [] [] [] - B A [] [] [] - C [] [] [] - [] [] [] - [] [] []

* FOR AIRLESS USE CODE A00 * IF BASE AND CASTER MODEL NUMBERS ARE LEFT BLANK THEN STANDARD OPTION WILL BE ASSUMED

PACKAGING NOTES

CODE	DESCRIPTION	LIST UPCHARGE
AB	ASSEMBLED IN BAG	\$0
PAC	PARTIALLY ASSEMBLED IN CARTON	\$0
BAC	BACK ASSEMBLED IN CARTON	\$80

UPHOLSTERED BACK

MODEL CONTROL DESCRIPTION

ARM FABRIC/LEATHER

FEATURES

DIMENSIONS

ARM OPTIONS

CASTERS

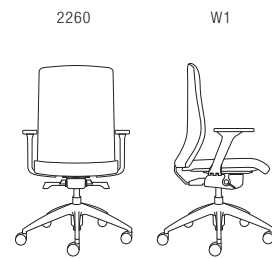

WEIGHT-BALANCED SYNCHRO TILT

ARM	A	B/COM	C	D	E	F	G	L3/COL	L4	L5
A00	800	840	870	910	970	1030	1085	975	1100	1200
A22B	870	910	940	980	1040	1100	1155	1045	1170	1270
A23B	895	935	965	1005	1065	1125	1180	1070	1195	1295
A36	925	965	995	1035	1095	1155	1210	1100	1225	1325

SEAT SLIDER (SS) - ADD \$60

- Automatic tension adjustment
- 2-position tilt lock
- 3:1 back-to-seat tilt ratio
- 360° swivel
- Pneumatic cylinder height adjustment

WIDTH: 27.5
 DEPTH: 27.5
 HEIGHT: 38.0-44.5
 SEAT WIDTH: 19.5
 SEAT DEPTH: 17.0
 SEAT HEIGHT: 15.0-19.5
 SEAT HEIGHT W/ SEAT SLIDER: 16.0-20.5
 BACK WIDTH: 18.5
 BACK HEIGHT: 23.0
 COM: 1.3 YD
 COL: 26.0 SQ FT
 WEIGHT: 43.0 LB



Fixed Arm with Soft Pad
A22B - Black



6-Way Height Adjustable Arm w/ Sliding Pad
A23B - Black



Hubless Hard Floor and Carpet Casters
C22B-Black
C22G-Gray



Height Adjustable Pivot/Slide Arm



Large Diameter Carpet Casters

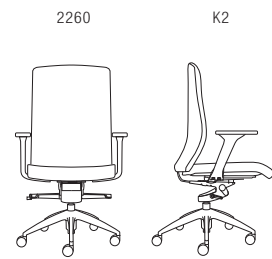

KNEE TILT

ARM	A	B/COM	C	D	E	F	G	L3/COL	L4	L5
A00	835	875	905	945	1005	1065	1120	1010	1135	1235
A22B	905	945	975	1015	1075	1135	1190	1080	1205	1305
A23B	930	970	1000	1040	1100	1160	1215	1105	1230	1330
A36	960	1000	1030	1070	1130	1190	1245	1135	1260	1360

SEAT SLIDER (SS) - ADD \$60

- 4-position tilt lock
- Side knob tension adjustment
- 360° swivel
- Pneumatic cylinder height adjustment

WIDTH: 27.5
 DEPTH: 27.5
 HEIGHT: 40.5-47.0
 SEAT WIDTH: 19.5
 SEAT DEPTH: 17.0
 SEAT HEIGHT: 17.5-22.5
 SEAT HEIGHT W/ SEAT SLIDER: 18.0-23.0
 BACK WIDTH: 18.5
 BACK HEIGHT: 23.0
 COM: 1.3 YD
 COL: 26.0 SQ FT
 WEIGHT: 43.0 LB

BASE OPTIONS



27" Mid-Profile Nylon Base
BA11B - Black



27" Mid-Profile Aluminum Base - Polished



Large Diameter Hard Floor and Carpet Casters



Chrome-Accented Hard Floor and Carpet Casters

ADDITIONAL OPTIONS



Seat Slider 2.5" Side Paddle Activated

PLASTIC COLOR



(OUTER BACK & ARMS)

core

contemporary lines for your workspace

STOOLS

GSA SIN # 33721

- Task, stool, conference and executive seating
- Poly outer back
- Ratchet back lumbar height adjustment
- Molded foam back over mesh suspension
- Hubless casters standard
- Warranted to 300 lbs.



CREATING CORE MODEL NUMBER



PACKAGING NOTES

CODE	DESCRIPTION	LIST UPCHARGE
AB	ASSEMBLED IN BAG	\$0
PAC	PARTIALLY ASSEMBLED IN CARTON	\$0
BAC	BACK ASSEMBLED IN CARTON	\$80

MODEL	CONTROL	DESCRIPTION	ARM	FABRIC/LEATHER	FEATURES	DIMENSIONS	ARM OPTIONS	CASTERS																																																		
2266	W1	10" STOOL WEIGHT-BALANCED SYNCHRO TILT Use for work surfaces up to 42"	A00 A22B A23B A36	<table border="1"> <thead> <tr> <th>A</th> <th>B/COM</th> <th>C</th> <th>D</th> <th>E</th> <th>F</th> <th>G</th> <th>L3/COL</th> <th>L4</th> <th>L5</th> </tr> </thead> <tbody> <tr> <td>925</td> <td>965</td> <td>995</td> <td>1035</td> <td>1095</td> <td>1155</td> <td>1210</td> <td>1100</td> <td>1225</td> <td>1325</td> </tr> <tr> <td>995</td> <td>1035</td> <td>1065</td> <td>1105</td> <td>1165</td> <td>1225</td> <td>1280</td> <td>1170</td> <td>1295</td> <td>1395</td> </tr> <tr> <td>1020</td> <td>1060</td> <td>1090</td> <td>1130</td> <td>1190</td> <td>1250</td> <td>1305</td> <td>1195</td> <td>1320</td> <td>1420</td> </tr> <tr> <td>1050</td> <td>1090</td> <td>1120</td> <td>1160</td> <td>1220</td> <td>1280</td> <td>1335</td> <td>1225</td> <td>1350</td> <td>1450</td> </tr> </tbody> </table>	A	B/COM	C	D	E	F	G	L3/COL	L4	L5	925	965	995	1035	1095	1155	1210	1100	1225	1325	995	1035	1065	1105	1165	1225	1280	1170	1295	1395	1020	1060	1090	1130	1190	1250	1305	1195	1320	1420	1050	1090	1120	1160	1220	1280	1335	1225	1350	1450	<ul style="list-style-type: none"> • Height-adjustable 20" diameter foot ring • Automatic tension adjustment • 2-position tilt lock • 3:1 back-to-seat tilt ratio • 360° swivel • Pneumatic cylinder height adjustment 	<p>WIDTH: 27.5 DEPTH: 27.5 HEIGHT: 46.0-58.5</p> <p>SEAT WIDTH: 19.5 SEAT DEPTH: 17.0 SEAT HEIGHT: 23.0-33.0 BACK WIDTH: 18.5 BACK HEIGHT: 23.0</p> <p>COM: 1.3 YD COL: 26.0 SQ FT WEIGHT: 49.0 LB</p>	<p>A22B \$70 Fixed Arm with Soft Pad A22B - Black</p> <p>A23B \$95 6-Way Height Adjustable Arm w/ Sliding Pad A23B - Black</p> <p>A36 \$125 Height Adjustable Pivot/Slide Arm</p>	<p>C22B/G STD Hubless Hard Floor and Carpet Casters C22B-Black C22G-Gray</p> <p>C6 NC Large Diameter Carpet Casters</p> <p>C6S \$35 Large Diameter Hard Floor and Carpet Casters</p> <p>C7 \$35 Chrome-Accented Hard Floor and Carpet Casters</p>
A	B/COM	C	D	E	F	G	L3/COL	L4	L5																																																	
925	965	995	1035	1095	1155	1210	1100	1225	1325																																																	
995	1035	1065	1105	1165	1225	1280	1170	1295	1395																																																	
1020	1060	1090	1130	1190	1250	1305	1195	1320	1420																																																	
1050	1090	1120	1160	1220	1280	1335	1225	1350	1450																																																	
2268	W1	8" STOOL WEIGHT-BALANCED SYNCHRO TILT Use for work surfaces up to 36"	A00 A22B A23B A36	<table border="1"> <thead> <tr> <th>A</th> <th>B/COM</th> <th>C</th> <th>D</th> <th>E</th> <th>F</th> <th>G</th> <th>L3/COL</th> <th>L4</th> <th>L5</th> </tr> </thead> <tbody> <tr> <td>925</td> <td>965</td> <td>995</td> <td>1035</td> <td>1095</td> <td>1155</td> <td>1210</td> <td>1100</td> <td>1225</td> <td>1325</td> </tr> <tr> <td>995</td> <td>1035</td> <td>1065</td> <td>1105</td> <td>1165</td> <td>1225</td> <td>1280</td> <td>1170</td> <td>1295</td> <td>1395</td> </tr> <tr> <td>1020</td> <td>1060</td> <td>1090</td> <td>1130</td> <td>1190</td> <td>1250</td> <td>1305</td> <td>1195</td> <td>1320</td> <td>1420</td> </tr> <tr> <td>1050</td> <td>1090</td> <td>1120</td> <td>1160</td> <td>1220</td> <td>1280</td> <td>1335</td> <td>1225</td> <td>1350</td> <td>1450</td> </tr> </tbody> </table>	A	B/COM	C	D	E	F	G	L3/COL	L4	L5	925	965	995	1035	1095	1155	1210	1100	1225	1325	995	1035	1065	1105	1165	1225	1280	1170	1295	1395	1020	1060	1090	1130	1190	1250	1305	1195	1320	1420	1050	1090	1120	1160	1220	1280	1335	1225	1350	1450	<ul style="list-style-type: none"> • Height-adjustable 20" diameter foot ring • Automatic tension adjustment • 2-position tilt lock • 3:1 back-to-seat tilt ratio • 360° swivel • Pneumatic cylinder height adjustment 	<p>WIDTH: 27.5 DEPTH: 27.5 HEIGHT: 43.0-53.5</p> <p>SEAT WIDTH: 19.5 SEAT DEPTH: 17.0 SEAT HEIGHT: 20.0-28.0 BACK WIDTH: 18.5 BACK HEIGHT: 23.0</p> <p>COM: 1.3 YD COL: 26.0 SQ FT WEIGHT: 48.0 LB</p>	<p>BA11B STD 27" Mid-Profile Nylon Base BA11B - Black</p> <p>BA12P \$110 27" Mid-Profile Aluminum Base - Polished</p>	<p>C6S \$35 Large Diameter Hard Floor and Carpet Casters</p> <p>C7 \$35 Chrome-Accented Hard Floor and Carpet Casters</p>
A	B/COM	C	D	E	F	G	L3/COL	L4	L5																																																	
925	965	995	1035	1095	1155	1210	1100	1225	1325																																																	
995	1035	1065	1105	1165	1225	1280	1170	1295	1395																																																	
1020	1060	1090	1130	1190	1250	1305	1195	1320	1420																																																	
1050	1090	1120	1160	1220	1280	1335	1225	1350	1450																																																	

PLASTIC COLOR

BLACK PBK **BLACK** NC
(OUTER BACK & ARMS)

cortina

simple, straightforward ergonomics and functionality

GSA SIN # 33721

- Task, conference and executive seating
- Polished aluminum base standard
- Clean, graceful lines
- Mid- or high-back options
- Warranted to 300 lbs.



CREATING CORTINA MODEL NUMBER



PACKAGING NOTES

CODE	DESCRIPTION	LIST UPCHARGE
AB	ASSEMBLED IN BAG	\$0
PAC	PARTIALLY ASSEMBLED IN CARTON	\$0
BAC	BACK ASSEMBLED IN CARTON	\$80

MID-BACK

MODEL	CONTROL	DESCRIPTION	ARM	FABRIC/LEATHER											FEATURES	DIMENSIONS	ARM OPTIONS			CASTERS					
				A	B/COM	C	D	E	F	G	L3/COL	L4	L5	A8B/S			A9B/S	C6	C6S	C7					
2900	S2	MID-BACK SWIVEL TILT	A00	1001	1056	1096	1146	1211	1291	1361	1236	1286	1441	<ul style="list-style-type: none"> • Adjustable back depth • Upright lock • Center knob tension adjustment • 360° swivel • Pneumatic cylinder height adjustment 	WIDTH: 25.0 DEPTH: 26.0 HEIGHT: 39.0-43.5 SEAT WIDTH: 20.5 SEAT DEPTH: 19.0 SEAT HEIGHT: 18.0-22.5 BACK WIDTH: 18.5 BACK HEIGHT: 21.0 COM: 1.5 YD COL: 33.0 SQ FT WEIGHT: 44.0 LB	A8B/S \$105 Height Adjustable Arm A8B - Black A8S - Silver	A9B/S \$115 Height/Width Adjustable Arm A9B - Black A9S - Silver	C6 NC Large Diameter Carpet Casters							
			A8B/S	1106	1161	1201	1251	1316	1396	1466	1341	1391	1546												
			A9B/S	1116	1171	1211	1261	1326	1406	1476	1351	1401	1556												
			A16	1126	1181	1221	1271	1336	1416	1486	1361	1411	1566												
			A19	1236	1291	1331	1381	1446	1526	1596	1471	1521	1676												
			A36	1126	1181	1221	1271	1336	1416	1486	1361	1411	1566												
			A37	1141	1196	1236	1286	1351	1431	1501	1376	1426	1581												
			A90	1236	1291	1331	1381	1446	1526	1596	1471	1521	1676												
							SEAT SLIDER (SS) - NOT AVAILABLE																		
			2900	Y2	MID-BACK HEAVY DUTY SYNCHRO TILT	A00	1081	1136	1176	1226	1291	1371	1441			1316	1366	1521	<ul style="list-style-type: none"> • 4-position tilt lock • Side knob tension adjustment • 2:1 back-to-seat tilt ratio • 360° swivel • Pneumatic cylinder height adjustment 	WIDTH: 25.0 DEPTH: 26.0 HEIGHT: 39.0-43.5 SEAT WIDTH: 20.5 SEAT DEPTH: 19.0 SEAT HEIGHT: 18.0-22.5 BACK WIDTH: 18.5 BACK HEIGHT: 21.0 COM: 1.5 YD COL: 33.0 SQ FT WEIGHT: 49.0 LB	A16 \$125 Soft Touch C-Shape Arm	A19 \$235 Polished Aluminum C-Shape Arm with Black Urethane Surface	C6S \$35 Large Diameter Hard Floor and Carpet Casters		
A8B/S	1186	1241				1281	1331	1396	1476	1546	1421	1471	1626												
A9B/S	1196	1251				1291	1341	1406	1486	1556	1431	1481	1636												
A16	1206	1261				1301	1351	1416	1496	1566	1441	1491	1646												
A19	1316	1371				1411	1461	1526	1606	1676	1551	1601	1756												
A36	1206	1261				1301	1351	1416	1496	1566	1441	1491	1646												
A37	1221	1276				1316	1366	1431	1511	1581	1456	1506	1661												
A90	1316	1371				1411	1461	1526	1606	1676	1551	1601	1756												
						SEAT SLIDER (SS) - NOT AVAILABLE																			
2900	M1	MID-BACK MULTI-FUNCTION				A00	1101	1156	1196	1246	1311	1391	1461	1336	1386	1541	<ul style="list-style-type: none"> • Infinite back angle adjustment • 6° forward tilt • Center knob tension adjustment • 360° swivel • Pneumatic cylinder height adjustment 	WIDTH: 25.0 DEPTH: 26.0 HEIGHT: 39.0-43.5 SEAT WIDTH: 20.5 SEAT DEPTH: 19.0 SEAT HEIGHT: 18.5-23.0 BACK WIDTH: 18.5 BACK HEIGHT: 21.0 COM: 1.5 YD COL: 33.0 SQ FT WEIGHT: 52.0 LB			A90 \$235 Height/Width Adjustable Breakaway Arm	BA1B DEDUCT \$50 26" Nylon Base - Black Only C1 casters available	BA11B DEDUCT \$50 27" Mid-Profile Nylon Base BA11B - Black	BA12P STD 27" Mid-Profile Aluminum Base - Polished (C7 Chrome-Accented Casters Standard with Polished Base)	
			A8B/S	1206	1261	1301	1351	1416	1496	1566	1441	1491	1646												
			A9B/S	1216	1271	1311	1361	1426	1506	1576	1451	1501	1656												
			A16	1226	1281	1321	1371	1436	1516	1586	1461	1511	1666												
			A19	1336	1391	1431	1481	1546	1626	1696	1571	1621	1776												
			A36	1226	1281	1321	1371	1436	1516	1586	1461	1511	1666												
			A37	1241	1296	1336	1386	1451	1531	1601	1476	1526	1681												
			A90	1336	1391	1431	1481	1546	1626	1696	1571	1621	1776												
							SEAT SLIDER (SS) - NOT AVAILABLE																		

cortina

simple, straightforward ergonomics and functionality

GSA SIN # 33721

- Task, conference and executive seating
- Polished aluminum base standard
- Clean, graceful lines
- Mid- or high-back options
- Warranted to 300 lbs.







CREATING CORTINA MODEL NUMBER



PACKAGING NOTES

CODE	DESCRIPTION	LIST UPCHARGE
AB	ASSEMBLED IN BAG	\$0
BAC	BACK ASSEMBLED IN CARTON	\$80

HIGH-BACK

MODEL	CONTROL	DESCRIPTION	ARM	FABRIC/LEATHER	FEATURES	DIMENSIONS	ARM OPTIONS	CASTERS	
2910	S2	HIGH-BACK SWIVEL TILT	A00	A B/COM C D E F G L3/COL L4 L5 1051 1111 1156 1211 1316 1406 1496 1296 1346 1531	<ul style="list-style-type: none"> • Adjustable back depth • Upright lock • Center knob tension adjustment • 360° swivel • Pneumatic cylinder height adjustment 	WIDTH: 25.0 DEPTH: 25.0 HEIGHT: 47.0-51.5 SEAT WIDTH: 20.5 SEAT DEPTH: 19.0 SEAT HEIGHT: 18.5-23.0 BACK WIDTH: 18.5 BACK HEIGHT: 29.0 COM: 1.7 YD COL: 40.0 SQ FT WEIGHT: 48.0 LB	 A8B/S \$105 Height Adjustable Arm A8B - Black A8S - Silver	 A9B/S \$115 Height/Width Adjustable Arm A9B - Black A9S - Silver	 C7 STD Chrome-Accented Hard Floor and Carpet Casters (Standard with Polished Base)
A8B/S	1156 1216 1261 1316 1421 1511 1601 1401 1451 1636								
A9B/S	1166 1226 1271 1326 1431 1521 1611 1411 1461 1646								
A16	1176 1236 1281 1336 1441 1531 1621 1421 1471 1656								
A19	1286 1346 1391 1446 1551 1641 1731 1531 1581 1766								
A36	1176 1236 1281 1336 1441 1531 1621 1421 1471 1656								
A37	1191 1251 1296 1351 1456 1546 1636 1436 1486 1671								
A90	1286 1346 1391 1446 1551 1641 1731 1531 1581 1766								
SEAT SLIDER (SS) - NOT AVAILABLE									
2910	Y2		HIGH-BACK HEAVY DUTY SYNCHRO TILT	A00					
A8B/S	1236 1296 1341 1396 1501 1591 1681 1481 1531 1716								
A9B/S	1246 1306 1351 1406 1511 1601 1691 1491 1541 1726								
A16	1256 1316 1361 1416 1521 1611 1701 1501 1551 1736								
A19	1366 1426 1471 1526 1631 1721 1811 1611 1661 1846								
A36	1256 1316 1361 1416 1521 1611 1701 1501 1551 1736								
A37	1271 1331 1376 1431 1536 1626 1716 1516 1566 1751								
A90	1366 1426 1471 1526 1631 1721 1811 1611 1661 1846								
SEAT SLIDER (SS) - NOT AVAILABLE									
2910	M1	HIGH-BACK MULTI-FUNCTION		A00	A B/COM C D E F G L3/COL L4 L5 1151 1211 1256 1311 1416 1506 1596 1396 1446 1631	<ul style="list-style-type: none"> • Infinite back angle adjustment • 6° forward tilt • Center knob tension adjustment • 360° swivel • Pneumatic cylinder height adjustment 	WIDTH: 25.0 DEPTH: 25.0 HEIGHT: 47.0-51.5 SEAT WIDTH: 20.5 SEAT DEPTH: 19.0 SEAT HEIGHT: 18.5-23.0 BACK WIDTH: 18.5 BACK HEIGHT: 29.0 COM: 1.7 YD COL: 40.0 SQ FT WEIGHT: 56.0 LB	 A90 \$235 Height/Width Adjustable Breakaway Arm	 C6 NC Large Diameter Hard Floor and Carpet Casters
A8B/S	1256 1316 1361 1416 1521 1611 1701 1501 1551 1736								
A9B/S	1266 1326 1371 1426 1531 1621 1711 1511 1561 1746								
A16	1276 1336 1381 1436 1541 1631 1721 1521 1571 1756								
A19	1386 1446 1491 1546 1651 1741 1831 1631 1681 1866								
A36	1276 1336 1381 1436 1541 1631 1721 1521 1571 1756								
A37	1291 1351 1396 1451 1556 1646 1736 1536 1586 1771								
A90	1386 1446 1491 1546 1651 1741 1831 1631 1681 1866								
SEAT SLIDER (SS) - NOT AVAILABLE									

BASE OPTIONS

 BA1B DEDUCT \$50 26" Nylon Base - Black Only C1 casters available	 BA11B DEDUCT \$50 27" Mid-Profile Nylon Base BA11B - Black	 BA12P STD 27" Mid-Profile Aluminum Base - Polished (C7 Chrome-Accented Casters Standard with Polished Base)
---	--	--

cosmo

contemporary style, elegance and comfort

GSA SIN # 33721

- Task, conference and executive seating
- Mesh or upholstered back options
- Mid- or high-back options
- Polished aluminum base standard
- Seat slider standard
- Warranted to 300 lbs.



CREATING COSMO MODEL NUMBER



PACKAGING NOTES

CODE	DESCRIPTION	LIST UPCHARGE
AB	ASSEMBLED IN BAG	\$0
BAC	BACK ASSEMBLED IN CARTON	\$0

MESH BACK - MB

MODEL	CONTROL	DESCRIPTION	ARM	FABRIC/LEATHER	FEATURES	DIMENSIONS																															
3250	X2	MESH MID-BACK DYNAMIC SYNCHRO TILT	A31	<table border="1"> <thead> <tr> <th>A</th> <th>B/COM</th> <th>C</th> <th>D</th> <th>E</th> <th>F</th> <th>G</th> <th>L3/COL</th> <th>L4</th> <th>L5</th> </tr> </thead> <tbody> <tr> <td>1273</td> <td>1303</td> <td>1333</td> <td>1388</td> <td>1433</td> <td>1478</td> <td>1503</td> <td>1448</td> <td>1473</td> <td>1623</td> </tr> <tr> <td>A38</td> <td>1273</td> <td>1303</td> <td>1333</td> <td>1388</td> <td>1433</td> <td>1478</td> <td>1503</td> <td>1448</td> <td>1473</td> <td>1623</td> </tr> </tbody> </table>	A	B/COM	C	D	E	F	G	L3/COL	L4	L5	1273	1303	1333	1388	1433	1478	1503	1448	1473	1623	A38	1273	1303	1333	1388	1433	1478	1503	1448	1473	1623	<ul style="list-style-type: none"> • Integrated seat slider • 11-position tilt lock • 10° forward tilt • Side knob tension adjustment • 2.6:1 back-to-seat tilt ratio • 360° swivel • Pneumatic cylinder height adjustment 	<p>WIDTH: 26.0-28.5 DEPTH: 25.0 HEIGHT: 40.0-45.5</p> <p>SEAT WIDTH: 20.0 SEAT DEPTH: 17.5-20.0 SEAT HEIGHT: 17.5-22.0 BACK WIDTH: 19.5 BACK HEIGHT: 22.0</p> <p>COM: 1.0 YD COL: 11.0 SQ FT WEIGHT: 42.0 LB</p>
A	B/COM		C	D	E	F	G	L3/COL	L4	L5																											
1273	1303	1333	1388	1433	1478	1503	1448	1473	1623																												
A38	1273	1303	1333	1388	1433	1478	1503	1448	1473	1623																											
3260	X2	MESH HIGH-BACK DYNAMIC SYNCHRO TILT	A31	<table border="1"> <thead> <tr> <th>A</th> <th>B/COM</th> <th>C</th> <th>D</th> <th>E</th> <th>F</th> <th>G</th> <th>L3/COL</th> <th>L4</th> <th>L5</th> </tr> </thead> <tbody> <tr> <td>1373</td> <td>1403</td> <td>1433</td> <td>1488</td> <td>1533</td> <td>1578</td> <td>1603</td> <td>1548</td> <td>1573</td> <td>1723</td> </tr> <tr> <td>A38</td> <td>1373</td> <td>1403</td> <td>1433</td> <td>1488</td> <td>1533</td> <td>1578</td> <td>1603</td> <td>1548</td> <td>1723</td> </tr> </tbody> </table>	A	B/COM	C	D	E	F	G	L3/COL	L4	L5	1373	1403	1433	1488	1533	1578	1603	1548	1573	1723	A38	1373	1403	1433	1488	1533	1578	1603	1548	1723	<ul style="list-style-type: none"> • Integrated seat slider • 11-position tilt lock • 10° forward tilt • Side knob tension adjustment • 2.6:1 back-to-seat tilt ratio • 360° swivel • Pneumatic cylinder height adjustment 	<p>WIDTH: 26.0-28.5 DEPTH: 25.0 HEIGHT: 47.0-51.5</p> <p>SEAT WIDTH: 20.0 SEAT DEPTH: 17.5-20.0 SEAT HEIGHT: 17.5-22.0 BACK WIDTH: 19.5 BACK HEIGHT: 29.0</p> <p>COM: 1.0 YD COL: 11.0 SQ FT WEIGHT: 44.0 LB</p>	
A	B/COM		C	D	E	F	G	L3/COL	L4	L5																											
1373	1403	1433	1488	1533	1578	1603	1548	1573	1723																												
A38	1373	1403	1433	1488	1533	1578	1603	1548	1723																												

ARM OPTIONS

A31
STD

Soft Touch Fixed Cantilever Arm - Black

A38
STD

Height Adjustable Arm

CASTERS

C7
STD

Chrome-Accented Hard Floor and Carpet Casters (Standard with Polished Base)

C6S
\$35

Large Diameter Hard Floor and Carpet Casters

C6
N/C

Large Diameter Carpet Casters

BASE OPTIONS

BA12B/P/S
STD

27" Mid-Profile Aluminum Base
BA12B - Black Powder Coat
BA12P - Polished
BA12S - Silver Powder Coat
(C7 Chrome-Accented Casters Standard with Polished Base)

MESH COLORS

M1	BLACK M11	GRAY M12	SILVER M13			
M2	BLACK M21	GRAY M22	WHITE M23	GREEN M24	RED M25	
M2	BLUE M26	ORANGE M27	AQUA M28			
M3	GRAPHITE M31	SLATE M32	SNOW M33			
M4	LATTE M40	CLOUD M41	LEMON M42	APPLE M43	TANGERINE M44	CRIMSON M46
M4	ONYX M48	DOVE M49	AZURE M50	FEDERAL BLUE M51	WHITE WHISPER M52	

M1 MESH
NC

M2, M3, M4 MESH
\$25

cosmo

contemporary style, elegance and comfort

GSA SIN # 33721

- Task, conference and executive
- Mesh or upholstered back options
- Mid- or high-back options
- Polished aluminum base standard
- Seat slider standard
- Warranted to 300 lbs.



CREATING COSMO MODEL NUMBER

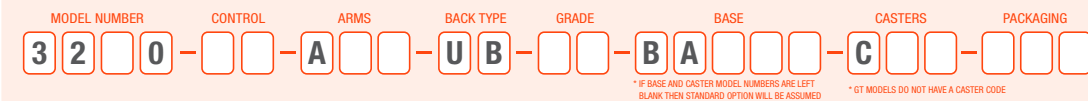

PACKAGING NOTES

CODE	DESCRIPTION	LIST UPCHARGE
AB	ASSEMBLED IN BAG	\$0
BAC	BACK ASSEMBLED IN CARTON	\$0

UPHOLSTERED BACK - UB

MODEL CONTROL DESCRIPTION

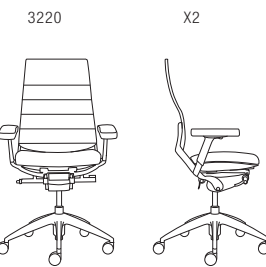

**UPHOLSTERED
MID-BACK
DYNAMIC SYNCHRO TILT**

ARM FABRIC/LEATHER

	A	B/COM	C	D	E	F	G	L3/COL	L4	L5
A31	1333	1383	1418	1453	1513	1568	1643	1583	1623	1853
A38	1333	1383	1418	1453	1513	1568	1643	1583	1623	1853

SEAT SLIDER (SS) - STANDARD

FEATURES

- Integrated seat slider
- 11-position tilt lock
- 10° forward tilt
- Side knob tension adjustment
- 2.6:1 back-to-seat tilt ratio
- 360° swivel
- Pneumatic cylinder height adjustment

DIMENSIONS

WIDTH: 26.0-28.5
DEPTH: 25.0
HEIGHT: 40.0-44.5
SEAT WIDTH: 20.0
SEAT DEPTH: 17.5-20.0
SEAT HEIGHT: 17.5-22.0
BACK WIDTH: 19.5
BACK HEIGHT: 22.0
COM: 1.6 YD
COL: 33.0 SQ FT
WEIGHT: 42.0 LB

ARM OPTIONS



CASTERS



BASE OPTIONS

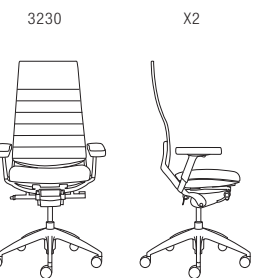
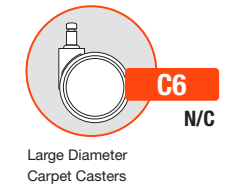

**UPHOLSTERED
HIGH-BACK
DYNAMIC SYNCHRO TILT**

	A	B/COM	C	D	E	F	G	L3/COL	L4	L5
A31	1433	1493	1533	1568	1628	1683	1758	1663	1683	1953
A38	1433	1493	1533	1568	1628	1683	1758	1663	1683	1953

SEAT SLIDER (SS) - STANDARD

- Integrated seat slider
- 11-position tilt lock
- 10° forward tilt
- Side knob tension adjustment
- 2.6:1 back-to-seat tilt ratio
- 360° swivel
- Pneumatic cylinder height adjustment

WIDTH: 26.0-28.5
DEPTH: 25.0
HEIGHT: 47.0-51.5
SEAT WIDTH: 20.0
SEAT DEPTH: 17.5-20
SEAT HEIGHT: 17.5-22.0
BACK WIDTH: 19.5
BACK HEIGHT: 29.0
COM: 1.8 YD
COL: 37.0 SQ FT
WEIGHT: 44.0 LB

cydia

organic design meets ergonomic excellence

GSA SIN # 33721

- Task, stool, conference, and executive seating
- Mesh or upholstered back options
- Three designer frame colors
- Mid-scale and full-scale sizes
- Warranted to 300 lbs.



CREATING CYDIA MODEL NUMBER

MODEL NUMBER CONTROL ARMS PLASTIC COLOR UPHOLSTERY MESH COLOR BASE CASTERS PACKAGING OPTIONS

3 3 - A - P - A - M - M - B - A - C - - - -

* FOR ARMLESS USE CODE A00 * IF BASE AND CASTER MODEL NUMBERS ARE LEFT BLANK THEN STANDARD OPTION WILL BE ASSUMED

PACKAGING NOTES

CODE	DESCRIPTION	LIST UPCHARGE
AB	ASSEMBLED IN BAG	\$0
BAC	BACK ASSEMBLED IN CARTON	\$0

ALL MESH

MODEL	CONTROL	DESCRIPTION	ARM	MESH	FEATURES	DIMENSIONS
3300	S3	MID-SCALE SWIVEL TILT	A00 A34B/G/W A35B/G/W	M 893 988 1018	<ul style="list-style-type: none"> • Upright lock • Center knob tension adjustment • 360° swivel • Pneumatic cylinder height adjustment 	WIDTH: 28.0 DEPTH: 27.5 HEIGHT: 34.0-38.5 SEAT WIDTH: 19.0 SEAT DEPTH: 16.0 SEAT HEIGHT: 17.0-21.5 BACK WIDTH: 18.0 BACK HEIGHT: 19.5 WEIGHT: 23.0 LB
3300	K3	MID-SCALE KNEE TILT	A00 A34B/G/W A35B/G/W	M 993 1088 1118	<ul style="list-style-type: none"> • 4-position tilt lock • Side knob tension adjustment • 360° swivel • Pneumatic cylinder height adjustment 	WIDTH: 28.0 DEPTH: 27.5 HEIGHT: 36.0-40.5 SEAT WIDTH: 19.0 SEAT DEPTH: 16.0 SEAT HEIGHT: 18.0-22.5 BACK WIDTH: 19.0 BACK HEIGHT: 19.5 WEIGHT: 30.0 LB
3310	S3	FULL-SCALE SWIVEL TILT	A00 A34B/G/W A35B/G/W	M 943 1038 1068	<ul style="list-style-type: none"> • Upright lock • Center knob tension adjustment • 360° swivel • Pneumatic cylinder height adjustment 	WIDTH: 28.0 DEPTH: 27.5 HEIGHT: 39.5-44.0 SEAT WIDTH: 19.0 SEAT DEPTH: 17.0 SEAT HEIGHT: 17.0-21.5 BACK WIDTH: 18.0 BACK HEIGHT: 23.5 WEIGHT: 26.0 LB
3310	K3	FULL-SCALE KNEE TILT	A00 A34B/G/W A35B/G/W	M 1043 1138 1168	<ul style="list-style-type: none"> • 4-position tilt lock • Side knob tension adjustment • 360° swivel • Pneumatic cylinder height adjustment 	WIDTH: 28.0 DEPTH: 27.5 HEIGHT: 41.5-46.0 SEAT WIDTH: 19.0 SEAT DEPTH: 17.0 SEAT HEIGHT: 18.0-22.5 BACK WIDTH: 18.0 BACK HEIGHT: 23.5 WEIGHT: 33.0 LB

ARM OPTIONS



A34B/G/W
\$95

Nylon Loop Arm
A34B - Black
A34G - Graphite Gray
A34W - White



A35B/G/W
\$125

Height Adjustable Arm
w/ Sliding Pad
A35B - Black
A35G - Graphite Gray
A35W - White

CASTER OPTIONS

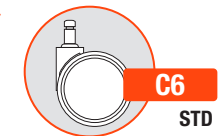

C6
STD

Large Diameter
Carpet Casters



C6S
\$35

Large Diameter Hard Floor
and Carpet Casters



C7
\$35

Chrome-Accented Hard
Floor and Carpet Casters

BASE OPTIONS



BA11B/G
STD

27" Mid-Profile Nylon Base
BA11B - Black
BA11D - Graphite



BA12B/P/S
\$110

27" Mid-Profile Aluminum Base
BA12B - Black Powder Coat
BA12P - Polished
BA12S - Silver Powder Coat

ADDITIONAL OPTIONS

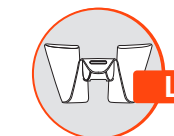

LB
\$30

Height Adjustable Lumbar
(Factory Installed)



G1
\$30

Stationary Base Glide

PLASTIC COLORS

BLACK PBK	GRAPHITE GRAY PGG	WHITE PWH
--------------	-------------------------	--------------

(BACK/SEAT FRAME AND ARMS)

BLACK
NC

GRAPHITE
\$35

WHITE
\$35

MESH COLORS

M1	BLACK M11	GRAY M12	SILVER M13
M3	GRAPHITE M31	SLATE M32	SNOW M33

M1 MESH
NC

M3 MESH
\$25

cydia

organic design meets ergonomic excellence

GSA SIN # 33721

- Task, stool, conference, and executive seating
- Mesh or upholstered back options
- Three designer frame colors
- Mid-scale and full-scale sizes
- Warranted to 300 lbs.



CREATING CYDIA MODEL NUMBER

MODEL NUMBER	CONTROL	ARMS	PLASTIC COLOR	UPHOLSTERY	MESH COLOR	BASE	CASTERS	PACKAGING	OPTIONS
330	S3	A	P	A	M	B	A	C	

* FOR ARMLESS USE CODE A00 * IF BASE AND CASTER MODEL NUMBERS ARE LEFT BLANK THEN STANDARD OPTION WILL BE ASSUMED

PACKAGING NOTES

CODE	DESCRIPTION	LIST UPCHARGE
AB	ASSEMBLED IN BAG	\$0
BAC	BACK ASSEMBLED IN CARTON	\$0

ALL MESH - STOOLS

MODEL	CONTROL	DESCRIPTION	ARM	MESH	FEATURES	DIMENSIONS
3306	S3	MID-SCALE 10" STOOL SWIVEL TILT Use for work surfaces up to 42" high	A00 A34B/G/W A35B/G/W	M 1018 1113 1143	<ul style="list-style-type: none"> • Height-adjustable 20" diameter foot ring • Upright lock • Center knob tension control • 360° swivel • Pneumatic cylinder height adjustment 	WIDTH: 28.0 DEPTH: 27.5 HEIGHT: 43.5-53.5 SEAT WIDTH: 19.0 SEAT DEPTH: 16.0 SEAT HEIGHT: 26.0-36.0 BACK WIDTH: 18.5 BACK HEIGHT: 19.5 WEIGHT: 43.0 LB
3308	S3	MID-SCALE 8" STOOL SWIVEL TILT Use for work surfaces up to 36" high	A00 A34B/G/W A35B/G/W	M 1018 1113 1143	<ul style="list-style-type: none"> • Height-adjustable 20" diameter foot ring • Upright lock • Center knob tension control • 360° swivel • Pneumatic cylinder height adjustment 	WIDTH: 28.0 DEPTH: 27.5 HEIGHT: 39.5-47.5 SEAT WIDTH: 19.0 SEAT DEPTH: 16.0 SEAT HEIGHT: 22.0-30.0 BACK WIDTH: 18.5 BACK HEIGHT: 19.5 WEIGHT: 42.0 LB

ARM OPTIONS



A34B/G/W
\$95

Nylon Loop Arm
A34B - Black
A34G - Graphite Gray
A34W - White



A35B/G/W
\$125

Height Adjustable Arm
w/ Sliding Pad
A35B - Black
A35G - Graphite Gray
A35W - White

CASTER OPTIONS

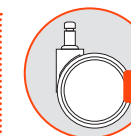

C6
STD

Large Diameter
Carpet Casters

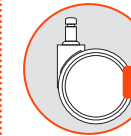

C6S
\$35

Large Diameter Hard Floor
and Carpet Casters



C7
\$35

Chrome-Accented Hard
Floor and Carpet Casters

BASE OPTIONS



BA11B/G
STD

27" Mid-Profile Nylon Base
BA11B - Black
BA11D - Graphite

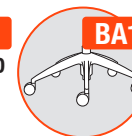

BA12B/P/S
\$110

27" Mid-Profile Aluminum Base
BA12B - Black Powder Coat
BA12P - Polished
BA12S - Silver Powder Coat

ADDITIONAL OPTIONS



LB
\$30

Height Adjustable Lumbar
(Factory Installed)



G1
\$30

Stationary Base Glide

PLASTIC COLORS

BLACK PBK	GRAPHITE GRAY PGG	WHITE PWH
--------------	-------------------------	--------------

(BACK/SEAT FRAME AND ARMS)

BLACK
NC

GRAPHITE
\$35

WHITE
\$35

MESH COLORS

M1	BLACK M11	GRAY M12	SILVER M13
M3	GRAPHITE M31	SLATE M32	SNOW M33

M1 MESH
NC

M3 MESH
\$25

cydia

organic design meets ergonomic excellence

GSA SIN # 33721

- Task, stool, conference, and executive seating
- Mesh or upholstered back options
- Three designer frame colors
- Mid-scale and full-scale sizes
- Warranted to 300 lbs.



CREATING CYDIA MODEL NUMBER



PACKAGING NOTES

CODE	DESCRIPTION	LIST UPCHARGE
AB	ASSEMBLED IN BAG	\$0
BAC	BACK ASSEMBLED IN CARTON	\$0

MODEL CONTROL DESCRIPTION

ARM FABRIC/LEATHER

FEATURES

DIMENSIONS

ARM OPTIONS

CASTER OPTIONS

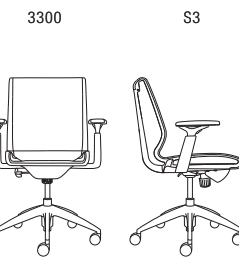

MID-SCALE SWIVEL TILT

ARM	A	B/COM	C	D	E	F	G	L3/COL	L4	L5
A00	1079	1124	1154	1194	1244	1299	1369	1299	1354	1719
A34B/G/W	1174	1219	1249	1289	1339	1394	1464	1349	1449	1814
A35B/G/W	1204	1249	1279	1319	1369	1424	1494	1379	1479	1844

- Upright lock
- Center knob tension adjustment
- 360° swivel
- Pneumatic cylinder height adjustment

WIDTH: 28.0
 DEPTH: 27.5
 HEIGHT: 34.0-38.5
 SEAT WIDTH: 19.0
 SEAT DEPTH: 16.0
 SEAT HEIGHT: 17.5-22.0
 BACK WIDTH: 18.0
 BACK HEIGHT: 19.5
 COM: 1.5 YD
 COL: 12.0 SQ FT
 WEIGHT: 36.0 LB



Nylon Loop Arm
 A34B - Black
 A34G - Graphite Gray
 A34W - White



Height Adjustable Arm
 w/ Sliding Pad
 A35B - Black
 A35G - Graphite Gray
 A35W - White



Large Diameter
 Carpet Casters

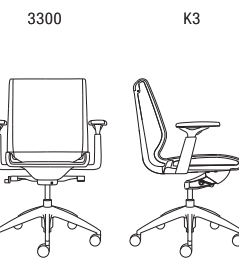

MID-SCALE KNEE TILT

ARM	A	B/COM	C	D	E	F	G	L3/COL	L4	L5
A00	1179	1224	1254	1294	1344	1399	1469	1354	1454	1819
A34B/G/W	1274	1319	1349	1389	1439	1494	1564	1449	1549	1914
A35B/G/W	1304	1349	1379	1419	1469	1524	1594	1479	1579	1944

- 4-position tilt lock
- Side knob tension adjustment
- 360° swivel
- Pneumatic cylinder height adjustment

WIDTH: 28.0
 DEPTH: 27.5
 HEIGHT: 36.0-40.5
 SEAT WIDTH: 19.0
 SEAT DEPTH: 16.0
 SEAT HEIGHT: 18.5-23.0
 BACK WIDTH: 19.0
 BACK HEIGHT: 19.5
 COM: 1.5 YD
 COL: 12.0 SQ FT
 WEIGHT: 43.0 LB

BASE OPTIONS



27" Mid-Profile Nylon Base
 BA11B - Black
 BA11D - Graphite



27" Mid-Profile Aluminum Base
 BA12B - Black Powder Coat
 BA12P - Polished
 BA12S - Silver Powder Coat



Large Diameter Hard Floor
 and Carpet Casters



Chrome-Accented Hard
 Floor and Carpet Casters

ADDITIONAL OPTIONS



Height Adjustable Lumbar
 (Factory Installed)

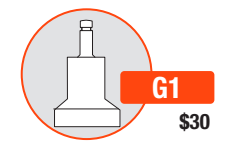

Stationary Base Glide

PLASTIC COLORS

BLACK PBK	GRAPHITE GRAY PGG	WHITE PWH	BLACK NC
			GRAPHITE \$35
			WHITE \$35

(BACK/SEAT FRAME AND ARMS)

MESH COLORS

M1	BLACK M11	GRAY M12	SILVER M13	M1 MESH NC
M3	GRAPHITE M31	SLATE M32	SNOW M33	M3 MESH \$25

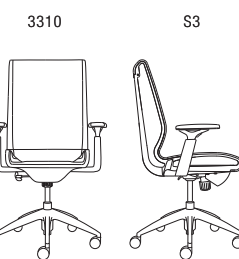

FULL-SCALE SWIVEL TILT

ARM	A	B/COM	C	D	E	F	G	L3/COL	L4	L5
A00	1129	1174	1204	1244	1294	1349	1419	1304	1404	1769
A34B/G/W	1224	1269	1299	1339	1389	1444	1514	1399	1499	1864
A35B/G/W	1254	1299	1329	1369	1419	1474	1544	1429	1529	1894

- Upright lock
- Center knob tension adjustment
- 360° swivel
- Pneumatic cylinder height adjustment

WIDTH: 28.0
 DEPTH: 27.5
 HEIGHT: 39.5-44.0
 SEAT WIDTH: 19.0
 SEAT DEPTH: 17.0
 SEAT HEIGHT: 17.5-22.0
 BACK WIDTH: 18.0
 BACK HEIGHT: 23.5
 COM: 1.7 YD
 COL: 14.0 SQ FT
 WEIGHT: 39.0 LB

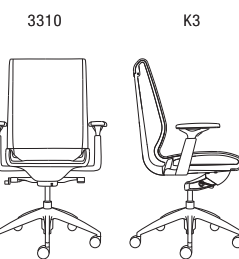

FULL-SCALE KNEE TILT

ARM	A	B/COM	C	D	E	F	G	L3/COL	L4	L5
A00	1229	1274	1304	1344	1394	1449	1519	1404	1504	1869
A34B/G/W	1324	1369	1399	1439	1489	1544	1614	1499	1599	1964
A35B/G/W	1354	1399	1429	1469	1519	1574	1644	1529	1629	1994

- 4-position tilt lock
- Side knob tension adjustment
- 360° swivel
- Pneumatic cylinder height adjustment

WIDTH: 28.0
 DEPTH: 27.5
 HEIGHT: 41.5-46.0
 SEAT WIDTH: 19.0
 SEAT DEPTH: 17.0
 SEAT HEIGHT: 18.5-23.0
 BACK WIDTH: 18.0
 BACK HEIGHT: 23.5
 COM: 1.7 YD
 COL: 14.0 SQ FT
 WEIGHT: 46.0 LB

cydia

organic design meets ergonomic excellence

GSA SIN # 33721

- Task, stool, conference, and executive seating
- Mesh or upholstered back options
- Three designer frame colors
- Mid-scale and full-scale sizes
- Warranted to 300 lbs.



CREATING CYDIA MODEL NUMBER



PACKAGING NOTES

CODE	DESCRIPTION	LIST UPCHARGE
AB	ASSEMBLED IN BAG	\$0
BAC	BACK ASSEMBLED IN CARTON	\$0

FULLY UPHOLSTERED - STOOLS

MODEL	CONTROL	DESCRIPTION	ARM	FABRIC/LEATHER	FEATURES	DIMENSIONS																																								
3306	S3	MID-SCALE 10" STOOL SWIVEL TILT Use for work surfaces up to 42" high	A00	<table border="1"> <thead> <tr> <th>A</th> <th>B/COM</th> <th>C</th> <th>D</th> <th>E</th> <th>F</th> <th>G</th> <th>L3/COL</th> <th>L4</th> <th>L5</th> </tr> </thead> <tbody> <tr> <td>1204</td> <td>1249</td> <td>1279</td> <td>1319</td> <td>1369</td> <td>1424</td> <td>1494</td> <td>1379</td> <td>1479</td> <td>1844</td> </tr> <tr> <td>1299</td> <td>1344</td> <td>1374</td> <td>1414</td> <td>1464</td> <td>1519</td> <td>1589</td> <td>1474</td> <td>1574</td> <td>1939</td> </tr> <tr> <td>1329</td> <td>1374</td> <td>1404</td> <td>1444</td> <td>1494</td> <td>1549</td> <td>1619</td> <td>1504</td> <td>1604</td> <td>1969</td> </tr> </tbody> </table>	A	B/COM	C	D	E	F	G	L3/COL	L4	L5	1204	1249	1279	1319	1369	1424	1494	1379	1479	1844	1299	1344	1374	1414	1464	1519	1589	1474	1574	1939	1329	1374	1404	1444	1494	1549	1619	1504	1604	1969	<ul style="list-style-type: none"> • Height-adjustable 20 diameter foot ring • Upright lock • Center knob tension control • 360° swivel • Pneumatic cylinder height adjustment 	WIDTH: 28.0 DEPTH: 27.5 HEIGHT: 43.5-53.5 SEAT WIDTH: 19.0 SEAT DEPTH: 16.0 SEAT HEIGHT: 26.5-36.5 BACK WIDTH: 18.5 BACK HEIGHT: 19.5 COM: 1.5 YD COL: 12.0 SQ FT WEIGHT: 43.0 LB
A	B/COM		C	D	E	F	G	L3/COL	L4	L5																																				
1204	1249		1279	1319	1369	1424	1494	1379	1479	1844																																				
1299	1344	1374	1414	1464	1519	1589	1474	1574	1939																																					
1329	1374	1404	1444	1494	1549	1619	1504	1604	1969																																					
A34B/G/W																																														
A35B/G/W																																														
3308	S3	MID-SCALE 8" STOOL SWIVEL TILT Use for work surfaces up to 36" high	A00	<table border="1"> <thead> <tr> <th>A</th> <th>B/COM</th> <th>C</th> <th>D</th> <th>E</th> <th>F</th> <th>G</th> <th>L3/COL</th> <th>L4</th> <th>L5</th> </tr> </thead> <tbody> <tr> <td>1204</td> <td>1249</td> <td>1279</td> <td>1319</td> <td>1369</td> <td>1424</td> <td>1494</td> <td>1379</td> <td>1479</td> <td>1844</td> </tr> <tr> <td>1299</td> <td>1344</td> <td>1374</td> <td>1414</td> <td>1464</td> <td>1519</td> <td>1589</td> <td>1474</td> <td>1574</td> <td>1939</td> </tr> <tr> <td>1329</td> <td>1374</td> <td>1404</td> <td>1444</td> <td>1494</td> <td>1549</td> <td>1619</td> <td>1504</td> <td>1604</td> <td>1969</td> </tr> </tbody> </table>	A	B/COM	C	D	E	F	G	L3/COL	L4	L5	1204	1249	1279	1319	1369	1424	1494	1379	1479	1844	1299	1344	1374	1414	1464	1519	1589	1474	1574	1939	1329	1374	1404	1444	1494	1549	1619	1504	1604	1969	<ul style="list-style-type: none"> • Height-adjustable 20 diameter foot ring • Upright lock • Center knob tension control • 360° swivel • Pneumatic cylinder height adjustment 	WIDTH: 28.0 DEPTH: 27.5 HEIGHT: 39.5-47.5 SEAT WIDTH: 19.0 SEAT DEPTH: 16.0 SEAT HEIGHT: 22.5-30.5 BACK WIDTH: 18.5 BACK HEIGHT: 19.5 COM: 1.5 YD COL: 12.0 SQ FT WEIGHT: 42.0 LB
A	B/COM		C	D	E	F	G	L3/COL	L4	L5																																				
1204	1249		1279	1319	1369	1424	1494	1379	1479	1844																																				
1299	1344	1374	1414	1464	1519	1589	1474	1574	1939																																					
1329	1374	1404	1444	1494	1549	1619	1504	1604	1969																																					
A34B/G/W																																														
A35B/G/W																																														

ARM OPTIONS



A34B/G/W
\$95

Nylon Loop Arm
A34B - Black
A34G - Graphite Gray
A34W - White



A35B/G/W
\$125

Height Adjustable Arm w/ Sliding Pad
A35B - Black
A35G - Graphite Gray
A35W - White

CASTER OPTIONS

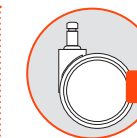

C6
STD

Large Diameter Carpet Casters

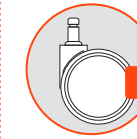

C6S
\$35

Large Diameter Hard Floor and Carpet Casters

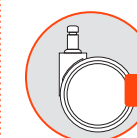

C7
\$35

Chrome-Accented Hard Floor and Carpet Casters

BASE OPTIONS



BA11B/G
STD

27" Mid-Profile Nylon Base
BA11B - Black
BA11D - Graphite



BA12B/P/S
\$110

27" Mid-Profile Aluminum Base
BA12B - Black Powder Coat
BA12P - Polished
BA12S - Silver Powder Coat

ADDITIONAL OPTIONS

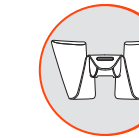

LB
\$30

Height Adjustable Lumbar (Factory Installed)



G1
\$30

Stationary Base Glide

PLASTIC COLORS

BLACK PBK	GRAPHITE GRAY PGG	WHITE PWH
--------------	-------------------------	--------------

(BACK/SEAT FRAME AND ARMS)

BLACK
NC

GRAPHITE
\$35

WHITE
\$35

MESH COLORS

M1	BLACK M11	GRAY M12	SILVER M13
M3	GRAPHITE M31	SLATE M32	SNOW M33

M1 MESH
NC

M3 MESH
\$25

dash

a cool sit with a modern look

ALL PLASTIC - AP - GUEST

GSA SIN # 33721 PENDING

- Stacking side, guest, task and stool
- Perforated breathable back
- Flexback movement
- All plastic and upholstered seat options
- Pull handle for easy mobility
- Warranted to 300 lbs.













CREATING DASH MODEL NUMBER

MODEL NUMBER CONTROL FRAME COLOR UPHOLSTERY PLASTIC COLOR CASTERS PACKAGING OPTIONS
1130-GT-F-AP-P-C-A

PACKAGING NOTES

CODE	DESCRIPTION	LIST UPCHARGE
AB	ASSEMBLED IN BAG	\$0
AC	ASSEMBLED IN CARTON	\$0

Dash stacking chairs ship up to 3 per carton

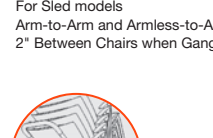
MODEL	CONTROL	DESCRIPTION	ARM	PLASTIC	FEATURES	DIMENSIONS	ARM OPTIONS	CASTER OPTIONS	ADDITIONAL OPTIONS	ACCESSORIES
1130	GT	4-LEG GUEST STACKING ARMLESS Plastic back with plastic seat	A00	P 327	<ul style="list-style-type: none"> • Stacks 4 high on the floor • Stacks 8 high on the optional stacking dolly • Arms and glides coordinate with the frame color • Non-marring floor glides 	WIDTH: 21.0 DEPTH: 21.0 HEIGHT: 34.0 SEAT WIDTH: 18.0 SEAT DEPTH: 16.0 SEAT HEIGHT: 18.0 BACK WIDTH: 18.0 BACK HEIGHT: 17.5 WEIGHT: 16.0 LB	 Nylon Fixed Arm for 4 leg models A53B - Black A53G - Cloud Gray	 Nylon Fixed Arm for sled model A54B - Black A54G - Cloud Gray	 Hard Floor and Carpet Casters	
1131	GT	4-LEG GUEST STACKING ARMED Plastic back with plastic seat	A53	P 382	<ul style="list-style-type: none"> • Stacks 4 high on the floor • Stacks 8 high on the optional stacking dolly • Arms and glides coordinate with the frame color • Non-marring floor glides 	WIDTH: 22.5 DEPTH: 21.0 HEIGHT: 34.0 SEAT WIDTH: 18.0 SEAT DEPTH: 16.0 SEAT HEIGHT: 18.0 BACK WIDTH: 18.0 BACK HEIGHT: 18.0 WEIGHT: 18.0 LB	 Sled Base Clear Plastic Glide - 4 per set	 Sled Base Clear Plastic Glide with Felt - 4 per set	 Ganging Clip-2 per set For 4-leg models Arm-to-Arm and Armless-to-Armless	
1130	GT	4-LEG GUEST STACKING ARMLESS WITH CASTERS Plastic back with plastic seat	A00	P 372	<ul style="list-style-type: none"> • Stacks 4 high on the floor • Stacks 8 high on the optional stacking dolly • Arms and glides coordinate with the frame color 	WIDTH: 21.0 DEPTH: 21.0 HEIGHT: 34.0 SEAT WIDTH: 18.0 SEAT DEPTH: 16.0 SEAT HEIGHT: 18.0 BACK WIDTH: 18.0 BACK HEIGHT: 17.5 WEIGHT: 16.0 LB	 Tapered Plastic Glide G21B - Black G21G - Gray	 Swivel Nylon Glide G21BN - Black Nylon G21GN - Gray Nylon	 Ganging Clip-2 per set For Sled models Arm-to-Arm and Armless-to-Armless 2" Between Chairs when Ganged	
1131	GT	4-LEG GUEST STACKING ARMED WITH CASTERS Plastic back with plastic seat	A53	P 427	<ul style="list-style-type: none"> • Stacks 4 high on the floor • Stacks 8 high on the optional stacking dolly • Arms and glides coordinate with the frame color 	WIDTH: 22.5 DEPTH: 21.0 HEIGHT: 34.0 SEAT WIDTH: 18.0 SEAT DEPTH: 16.0 SEAT HEIGHT: 18.0 BACK WIDTH: 18.0 BACK HEIGHT: 18.0 WEIGHT: 18.0 LB	 Swivel Steel Glide G21BS - Black Steel G21GS - Gray Steel	 Swivel Felt Glide G21BF - Black Felt G21GF - Gray Felt	 Stacking Dolly Stacks up to 8 High - 4-Leg Models* Stacks up to 20 High - Sled Models*	
1134	GT	SLED GUEST STACKING ARMLESS Plastic back with plastic seat	A00	P 301	<ul style="list-style-type: none"> • Stacks 7 high on the floor • Stacks 20 high on the optional stacking dolly • Arms and glides coordinate with the frame color • Optional glides available 	WIDTH: 21.0 DEPTH: 21.0 HEIGHT: 36.0 SEAT WIDTH: 18.0 SEAT DEPTH: 16.0 SEAT HEIGHT: 18.0 BACK WIDTH: 18.0 BACK HEIGHT: 17.5 WEIGHT: 16.0 LB				
1135	GT	SLED GUEST STACKING ARMED Plastic back with plastic seat	A54	P 356	<ul style="list-style-type: none"> • Stacks 7 high on the floor • Stacks 20 high on the optional stacking dolly • Arms and glides coordinate with the frame color • Optional glides available 	WIDTH: 21.0 DEPTH: 21.0 HEIGHT: 36.0 SEAT WIDTH: 18.0 SEAT DEPTH: 16.0 SEAT HEIGHT: 18.0 BACK WIDTH: 18.0 BACK HEIGHT: 17.5 WEIGHT: 18.0 LB				

CAUTION: Careless stacking of chairs may scratch and damage frames.
 *Due to the nature of vinyl upholstery, stacking may cause impressions on the seat. 9to5 Seating does not warrant the effects of the stacking on vinyl upholstery.

FRAME COLORS

BLACK BF	SILVER SF
-------------	--------------

PLASTIC COLORS

BLACK SWAN P01	WHITE WHISPER P05	FEDERAL BLUE P11	CRIMSON RED P12
LEMON YELLOW P13	DOVE GRAY P14	CLOUD GRAY P15	LAGOON BLUE P16
APPLE GREEN P17	TANGERINE ORANGE P18	LATTE P19	AZURE BLUE P20

dash

a cool sit with a modern look

GSA SIN # 33721 PENDING

- Stacking side, guest, task and stool
- Perforated breathable back
- Flexback movement
- All plastic and upholstered seat options
- Pull handle for easy mobility
- Warranted to 300 lbs.



CREATING DASH MODEL NUMBER

MODEL NUMBER CONTROL FRAME COLOR UPHOLSTERY PLASTIC COLOR PACKAGING OPTIONS
1 1 3 - **S T** - **F** - **A P** - **P** - **A** -

PACKAGING NOTES

CODE	DESCRIPTION	LIST UPCHARGE
AB	ASSEMBLED IN BAG	\$0
AC	ASSEMBLED IN CARTON	\$0

Dash stools ship 1 per carton

ALL PLASTIC - AP - STOOLS

MODEL	CONTROL	DESCRIPTION	ARM	PLASTIC	FEATURES	DIMENSIONS
1130	ST24	24" COUNTER STOOL ARMLESS Plastic back with plastic seat	A00	P 457	<ul style="list-style-type: none"> • Stacks 4 high on the floor • Arms and glides coordinate with the frame color • Non-marring floor glides 	WIDTH: 21.0 DEPTH: 21.0 HEIGHT: 39.5 SEAT WIDTH: 18.0 SEAT DEPTH: 16.0 SEAT HEIGHT: 24.0 BACK WIDTH: 18.0 BACK HEIGHT: 17.5 WEIGHT: 21.5 LB
1131	ST24	24" COUNTER STOOL WITH ARMS Plastic back with plastic seat	A53	P 512	<ul style="list-style-type: none"> • Stacks 4 high on the floor • Arms and glides coordinate with the frame color • Non-marring floor glides 	WIDTH: 22.5 DEPTH: 21.0 HEIGHT: 39.5 SEAT WIDTH: 18.0 SEAT DEPTH: 16.0 SEAT HEIGHT: 24.0 BACK WIDTH: 18.0 BACK HEIGHT: 17.5 WEIGHT: 23.5 LB
1130	ST30	30" BAR STOOL ARMLESS Plastic back with plastic seat	A00	P 477	<ul style="list-style-type: none"> • Stacks 4 high on the floor • Arms and glides coordinate with the frame color • Non-marring floor glides 	WIDTH: 21.0 DEPTH: 21.0 HEIGHT: 45.5 SEAT WIDTH: 18.0 SEAT DEPTH: 16.0 SEAT HEIGHT: 30.0 BACK WIDTH: 18.0 BACK HEIGHT: 17.5 WEIGHT: 24.0 LB
1131	ST30	30" BAR STOOL WITH ARMS Plastic back with plastic seat	A53	P 532	<ul style="list-style-type: none"> • Stacks 4 high on the floor • Arms and glides coordinate with the frame color • Non-marring floor glides 	WIDTH: 22.5 DEPTH: 21.0 HEIGHT: 45.5 SEAT WIDTH: 18.0 SEAT DEPTH: 16.0 SEAT HEIGHT: 30.0 BACK WIDTH: 18.0 BACK HEIGHT: 17.5 WEIGHT: 26.0 LB

ARM OPTIONS



A53B/G
STD
Nylon Fixed Arm for 4 leg models
A53B - Black
A53G - Cloud Gray

ADDITIONAL OPTIONS



G21B/G
NC
Tapered Plastic Glide
G21B - Black
G21G - Gray



G21BN/GN
\$20
Swivel Nylon Glide
G21BN - Black Nylon
G21GN - Gray Nylon



G21BS/GS
\$20
Swivel Steel Glide
G21BS - Black Steel
G21GS - Gray Steel



G21BF/GF
\$20
Swivel Felt Glide
G21BF - Black Felt
G21GF - Gray Felt

FRAME COLORS

BLACK BF	SILVER SF
-------------	--------------

PLASTIC COLORS

BLACK SWAN P01	WHITE WHISPER P05	FEDERAL BLUE P11	CRIMSON RED P12	LEMON YELLOW P13	DOVE GRAY P14
CLOUD GRAY P15	LAGOON BLUE P16	APPLE GREEN P17	TANGERINE ORANGE P18	LATTE P19	AZURE BLUE P20

(BACK AND SEAT)

dash

a cool sit with a modern look

GSA SIN # 33721 PENDING

- Stacking side, guest, task and stool
- Perforated breathable back
- Flexback movement
- All plastic and upholstered seat options
- Pull handle for easy mobility
- Warranted to 300 lbs.



CREATING DASH MODEL NUMBER

MODEL NUMBER	CONTROL	FRAME COLOR	UPHOLSTERY	PLASTIC COLOR	GRADE	CASTERS	PACKAGING	OPTIONS
113	GT	F	US	P		C	A	

PACKAGING NOTES

CODE	DESCRIPTION	LIST UPCHARGE
AB	ASSEMBLED IN BAG	\$0
AC	ASSEMBLED IN CARTON	\$0

Dash stacking chairs ship up to 3 per carton

UPHOLSTERED SEAT - US - GUEST

MODEL	CONTROL	DESCRIPTION	ARM	FABRIC/LEATHER											FEATURES	DIMENSIONS					
				A	B/COM	C	D	E	F	G	L3/COL	L4	L5	WIDTH:		DEPTH:	HEIGHT:	SEAT WIDTH:	SEAT DEPTH:	SEAT HEIGHT:	BACK WIDTH:
1130	GT	4-LEG GUEST STACKING ARMLESS Plastic back with upholstered seat	A00	381	403	426	456	491	526	556	531	581	651	<ul style="list-style-type: none"> • Stacks 4 high on the floor • Stacks 8 high on the optional stacking dolly • Arms and glides coordinate with the frame color • Non-marring floor glides 	WIDTH: 21.0 DEPTH: 21.0 HEIGHT: 34.0 SEAT WIDTH: 18.0 SEAT DEPTH: 16.0 SEAT HEIGHT: 18.0 BACK WIDTH: 18.0 BACK HEIGHT: 17.5 COM: 0.5 YD COL: 3.91 SQ FT WEIGHT: 16.0 LB						
1131	GT	4-LEG GUEST STACKING ARMED Plastic back with upholstered seat	A53	436	458	481	511	546	581	611	586	636	706	<ul style="list-style-type: none"> • Stacks 4 high on the floor • Stacks 8 high on the optional stacking dolly • Arms and glides coordinate with the frame color • Non-marring floor glides 	WIDTH: 22.5 DEPTH: 21.0 HEIGHT: 34.0 SEAT WIDTH: 18.0 SEAT DEPTH: 16.0 SEAT HEIGHT: 18.0 BACK WIDTH: 18.0 BACK HEIGHT: 17.5 COM: 0.5 YD COL: 3.91 SQ FT WEIGHT: 18.0 LB						
1130	GT	4-LEG GUEST STACKING ARMLESS WITH CASTERS Plastic back with upholstered seat	A00	426	448	471	501	536	571	601	576	626	696	<ul style="list-style-type: none"> • Stacks 4 high on the floor • Stacks 8 high on the optional stacking dolly • Arms and glides coordinate with the frame color 	WIDTH: 21.0 DEPTH: 21.0 HEIGHT: 34.0 SEAT WIDTH: 18.0 SEAT DEPTH: 16.0 SEAT HEIGHT: 18.0 BACK WIDTH: 18.0 BACK HEIGHT: 17.5 COM: 0.5 YD COL: 3.91 SQ FT WEIGHT: 16.0 LB						
1131	GT	4-LEG GUEST STACKING ARMED WITH CASTERS Plastic back with upholstered seat	A53	481	503	526	556	591	626	656	631	681	751	<ul style="list-style-type: none"> • Stacks 4 high on the floor • Stacks 8 high on the optional stacking dolly • Arms and glides coordinate with the frame color 	WIDTH: 22.5 DEPTH: 21.0 HEIGHT: 34.0 SEAT WIDTH: 18.0 SEAT DEPTH: 16.0 SEAT HEIGHT: 18.0 BACK WIDTH: 18.0 BACK HEIGHT: 17.5 COM: 0.5 YD COL: 3.91 SQ FT WEIGHT: 18.0 LB						
1134	GT	SLED GUEST STACKING ARMLESS Plastic back with upholstered seat	A00	355	377	400	430	465	500	530	505	555	625	<ul style="list-style-type: none"> • Stacks 7 high on the floor • Stacks 20 high on the optional stacking dolly • Arms and glides coordinate with the frame color • Optional glides available 	WIDTH: 21.0 DEPTH: 21.0 HEIGHT: 36.0 SEAT WIDTH: 18.0 SEAT DEPTH: 16.0 SEAT HEIGHT: 18.0 BACK WIDTH: 18.0 BACK HEIGHT: 17.5 COM: 0.5 YD COL: 3.91 SQ FT WEIGHT: 16.0 LB						
1135	GT	SLED GUEST STACKING ARMED Plastic back with upholstered seat	A54	410	432	455	485	520	555	585	560	610	680	<ul style="list-style-type: none"> • Stacks 7 high on the floor • Stacks 20 high on the optional stacking dolly • Arms and glides coordinate with the frame color • Optional glides available 	WIDTH: 21.0 DEPTH: 21.0 HEIGHT: 36.0 SEAT WIDTH: 18.0 SEAT DEPTH: 16.0 SEAT HEIGHT: 18.0 BACK WIDTH: 18.0 BACK HEIGHT: 17.5 COM: 0.5 YD COL: 3.91 SQ FT WEIGHT: 18.0 LB						

CAUTION: Careless stacking of chairs may scratch and damage frames.
 *Due to the nature of vinyl upholstery, stacking may cause impressions on the seat. 9to5 Seating does not warrant the effects of the stacking on vinyl upholstery.

ARM OPTIONS

A53B/G
STD

Nylon Fixed Arm for 4 leg models
A53B - Black
A53G - Cloud Gray

A54B/G
STD

Nylon Fixed Arm for sled model
A54B - Black
A54G - Cloud Gray

CASTER OPTIONS

C12S
STD

Hard Floor and Carpet Casters

ADDITIONAL OPTIONS

G16
\$15

Sled Base Clear Plastic Glide - 4 per set

G17
\$25

Sled Base Clear Plastic Glide with Felt - 4 per set

G21B/G
NC

Tapered Plastic Glide
G21B - Black
G21G - Gray

G21BN/GN
\$20

Swivel Nylon Glide
G21BN - Black Nylon
G21GN - Gray Nylon

G21BN/GS
\$20

Swivel Steel Glide
G21BS - Black Steel
G21GS - Gray Steel

G21BF/GF
\$20

Swivel Felt Glide
G21BF - Black Felt
G21GF - Gray Felt

ACCESSORIES

GC7
\$30

Ganging Clip-2 per set
For 4-leg models
Arm-to-Arm and Armless-to-Armless

GC8
\$20

Ganging Clip-2 per set
For Sled models
Arm-to-Arm and Armless-to-Armless
2" Between Chairs when Ganged

DL5
\$399

Stacking Dolly
Stacks up to 8 High - 4-Leg Models*
Stacks up to 20 High - Sled Models*

FRAME COLORS

BLACK BF	SILVER SF
-------------	--------------

PLASTIC COLORS

BLACK SWAN P01	WHITE WHISPER P05	FEDERAL BLUE P11	CRIMSON RED P12
LEMON YELLOW P13	DOVE GRAY P14	CLOUD GRAY P15	LAGOON BLUE P16
APPLE GREEN P17	TANGERINE ORANGE P18	LATTE P19	AZURE BLUE P20

(BACK AND SEAT)

dash

a cool sit with a modern look

GSA SIN # 33721 PENDING

- Stacking side, guest, task and stool
- Perforated breathable back
- Flexback movement
- All plastic and upholstered seat options
- Pull handle for easy mobility
- Warranted to 300 lbs.



CREATING DASH MODEL NUMBER

MODEL NUMBER CONTROL FRAME COLOR UPHOLSTERY PLASTIC COLOR GRADE PACKAGING OPTIONS
1130-ST-F-US-P-A

PACKAGING NOTES

CODE	DESCRIPTION	LIST UPCHARGE
AB	ASSEMBLED IN BAG	\$0
AC	ASSEMBLED IN CARTON	\$0

Dash stools ship 1 per carton

UPHOLSTERED SEAT - US - STOOLS

MODEL	CONTROL	DESCRIPTION	ARM	FABRIC/LEATHER										FEATURES	DIMENSIONS						
				A	B/COM	C	D	E	F	G	L3/COL	L4	L5		WIDTH:	DEPTH:	HEIGHT:	SEAT WIDTH:	SEAT DEPTH:	SEAT HEIGHT:	BACK WIDTH:
1130	ST24	24" COUNTER STOOL ARMLESS Plastic back with upholstered seat	A00	511	533	556	586	621	656	686	661	711	781	<ul style="list-style-type: none"> • Stacks 4 high on the floor • Arms and glides coordinate with the frame color • Non-marring floor glides 	WIDTH: 21.0 DEPTH: 21.0 HEIGHT: 39.5 SEAT WIDTH: 18.0 SEAT DEPTH: 16.0 SEAT HEIGHT: 24.0 BACK WIDTH: 18.0 BACK HEIGHT: 17.5 COM: 0.5 YD COL: 3.91 SQ FT WEIGHT: 21.5 LB						
1131	ST24	24" COUNTER STOOL WITH ARMS Plastic back with upholstered seat	A53	566	588	611	641	676	711	741	716	766	836	<ul style="list-style-type: none"> • Stacks 4 high on the floor • Arms and glides coordinate with the frame color • Non-marring floor glides 	WIDTH: 21.0 DEPTH: 21.0 HEIGHT: 39.5 SEAT WIDTH: 18.0 SEAT DEPTH: 16.0 SEAT HEIGHT: 24.0 BACK WIDTH: 18.0 BACK HEIGHT: 17.5 COM: 0.5 YD COL: 3.91 SQ FT WEIGHT: 21.5 LB						
1130	ST30	30" BAR STOOL ARMLESS Plastic back with upholstered seat	A00	531	553	576	606	641	676	706	681	731	801	<ul style="list-style-type: none"> • Stacks 4 high on the floor • Arms and glides coordinate with the frame color • Non-marring floor glides 	WIDTH: 21.5 DEPTH: 21.0 HEIGHT: 45.5 SEAT WIDTH: 18.5 SEAT DEPTH: 16.0 SEAT HEIGHT: 30.0 BACK WIDTH: 18.0 BACK HEIGHT: 17.5 COM: 0.5 YD COL: 3.91 SQ FT WEIGHT: 24.0 LB						
1131	ST30	30" BAR STOOL WITH ARMS Plastic back with upholstered seat	A53	586	608	631	661	696	731	761	736	786	856	<ul style="list-style-type: none"> • Stacks 4 high on the floor • Arms and glides coordinate with the frame color • Non-marring floor glides 	WIDTH: 22.5 DEPTH: 21.0 HEIGHT: 45.5 SEAT WIDTH: 18.0 SEAT DEPTH: 16.0 SEAT HEIGHT: 30.0 BACK WIDTH: 18.0 BACK HEIGHT: 17.5 COM: 0.5 YD COL: 3.91 SQ FT WEIGHT: 26.0 LB						

ARM OPTIONS



A53B/G
STD
Nylon Fixed Arm for 4 leg models
A53B - Black
A53G - Cloud Gray

ADDITIONAL OPTIONS



G21B/G
NC
Tapered Plastic Glide
G21B - Black
G21G - Gray



G21BN/GN
\$20
Swivel Nylon Glide
G21BN - Black Nylon
G21GN - Gray Nylon



G21BS/GS
\$20
Swivel Steel Glide
G21BS - Black Steel
G21GS - Gray Steel



G21BF/GF
\$20
Swivel Felt Glide
G21BF - Black Felt
G21GF - Gray Felt

FRAME COLORS

BLACK BF	SILVER SF
-------------	--------------

PLASTIC COLORS

BLACK SWAN P01	WHITE WHISPER P05	FEDERAL BLUE P11	CRIMSON RED P12	LEMON YELLOW P13	DOVE GRAY P14
CLOUD GRAY P15	LAGOON BLUE P16	APPLE GREEN P17	TANGERINE ORANGE P18	LATTE P19	AZURE BLUE P20

(BACK AND SEAT)

dash

a cool sit with a modern look

GSA SIN # 33721 PENDING

- Stacking side, guest, task and stool
- Perforated breathable back
- Flexback movement
- All plastic and upholstered seat options
- Pull handle for easy mobility
- Warranted to 300 lbs.



CREATING DASH MODEL NUMBER

MODEL NUMBER	CONTROL	FRAME COLOR	UPHOLSTERY	PLASTIC COLOR	BASE	CASTERS	PACKAGING
113		F	A	P	B	A	1

PACKAGING NOTES

CODE	DESCRIPTION	LIST UPCHARGE
AB	ASSEMBLED IN BAG	\$0
BAC	BACK ASSEMBLED IN CARTON	\$0

ALL PLASTIC - AP - TASK

MODEL	CONTROL	DESCRIPTION	ARM	PLASTIC	FEATURES	DIMENSIONS
1132	B1	BASIC TASK ARMLESS Plastic back with plastic seat	A00	P 452	<ul style="list-style-type: none"> • 360° swivel • Pneumatic cylinder height adjustment • Stool options available for \$125 upcharge. See stool option section. 	WIDTH: 26.5 DEPTH: 26.5 HEIGHT: 33.5 SEAT WIDTH: 18.0 SEAT DEPTH: 16.0 SEAT HEIGHT: 16.0-20.5 BACK WIDTH: 18.0 BACK HEIGHT: 17.5 WEIGHT: 28.0 LB
1133	B1	BASIC TASK ARMED Plastic back with plastic seat	A53	P 507	<ul style="list-style-type: none"> • 360° swivel • Pneumatic cylinder height adjustment • Arms coordinate with the frame color • Stool options available for \$125 upcharge. See stool option section. 	WIDTH: 26.5 DEPTH: 26.5 HEIGHT: 33.5 SEAT WIDTH: 18.0 SEAT DEPTH: 16.0 SEAT HEIGHT: 16.0-20.5 BACK WIDTH: 18.0 BACK HEIGHT: 17.5 WEIGHT: 28.0 LB
1132	S3	SWIVEL TILT ARMLESS Plastic back with plastic seat	A00	P 487	<ul style="list-style-type: none"> • Upright lock • Center knob tension adjustment • 360° swivel • Pneumatic cylinder height adjustment • Stool options available for \$125 upcharge. See stool option section. 	WIDTH: 26.5 DEPTH: 26.5 HEIGHT: 39.0 SEAT WIDTH: 18.0 SEAT DEPTH: 16.5 SEAT HEIGHT: 21.0 BACK WIDTH: 18.0 BACK HEIGHT: 17.5 WEIGHT: 17.5 LB
1133	S3	SWIVEL TILT ARMED Plastic back with plastic seat	A53	P 542	<ul style="list-style-type: none"> • Upright lock • Center knob tension adjustment • 360° swivel • Pneumatic cylinder height adjustment • Arms and glides coordinate with the frame color • Stool options available for \$125 upcharge. See stool option section. 	WIDTH: 26.5 DEPTH: 26.5 HEIGHT: 39.0 SEAT WIDTH: 18.0 SEAT DEPTH: 16.5 SEAT HEIGHT: 21.0 BACK WIDTH: 18.0 BACK HEIGHT: 17.5 WEIGHT: 17.5 LB
1132	R2	ROCKING TILT ARMLESS Plastic back with plastic seat	A00	P 542	<ul style="list-style-type: none"> • Rock left, right, front and back • 360° swivel • Pneumatic cylinder height adjustment • Stool options available for \$125 upcharge. See stool option section. 	WIDTH: 26.5 DEPTH: 26.5 HEIGHT: 39.0 SEAT WIDTH: 18.0 SEAT DEPTH: 16.0 SEAT HEIGHT: 21.5 BACK WIDTH: 18.0 BACK HEIGHT: 17.5 WEIGHT: 24.5 LB
1133	R2	ROCKING TILT ARMED Plastic back with plastic seat	A53	P 597	<ul style="list-style-type: none"> • Rock left, right, front and back • 360° swivel • Pneumatic cylinder height adjustment • Arms coordinate with the frame color • Stool options available for \$125 upcharge. See stool option section. 	WIDTH: 26.5 DEPTH: 26.5 HEIGHT: 39.0 SEAT WIDTH: 18.0 SEAT DEPTH: 17.0 SEAT HEIGHT: 21.5 BACK WIDTH: 18.0 BACK HEIGHT: 17.5 WEIGHT: 24.5 LB

ARM OPTIONS



Nylon Fixed Arm for 4 leg models
A53B - Black
A53G - Cloud Gray

BASE OPTIONS



27" Mid-Profile Nylon Base
BA11B - Black
BA11D - Graphite



27" Mid-Profile Aluminum Base
BA12B - Black Powder Coat
BA12P - Polished
BA12S - Silver Powder Coat

STOOL OPTIONS



CY30B - 8" Stool
(Seat Height: 22"-30")
Use for work surfaces up to 36"



CY36B - 10" Stool
(Seat Height: 25"-36")
Use for work surfaces up to 42"

FRAME COLORS

BLACK BF	SILVER SF
-------------	--------------

PLASTIC COLORS

BLACK SWAN P01	WHITE WHISPER P05	FEDERAL BLUE P11	CRIMSON RED P12	LEMON YELLOW P13	DOVE GRAY P14
CLOUD GRAY P15	LAGOON BLUE P16	APPLE GREEN P17	TANGERINE ORANGE P18	LATTE P19	AZURE BLUE P20

(BACK AND SEAT)

dash

a cool sit with a modern look

GSA SIN # 33721 PENDING

- Stacking side, guest, task and stool
- Perforated breathable back
- Flexback movement
- All plastic and upholstered seat options
- Pull handle for easy mobility
- Warranted to 300 lbs.



CREATING DASH MODEL NUMBER

MODEL NUMBER	CONTROL	FRAME COLOR	UPHOLSTERY	PLASTIC COLOR	GRADE	BASE	CASTERS	PACKAGING
113	G T	F	U S	P		B A 1	P	

PACKAGING NOTES

CODE	DESCRIPTION	LIST UPCHARGE
AB	ASSEMBLED IN BAG	\$0
BAC	BACK ASSEMBLED IN CARTON	\$0

UPHOLSTERED SEAT - US - TASK

MODEL	CONTROL	DESCRIPTION	ARM	FABRIC	FEATURES	DIMENSIONS			
							A	B/COM	C
1132	B1	BASIC TASK ARMLESS Plastic back with upholstered seat	A00	506 528 551 581 616 651 681 656 706 776	<ul style="list-style-type: none"> • 360° swivel • Pneumatic cylinder height adjustment • Stool options available for \$125 upcharge. See stool option section. 	WIDTH: 26.5 DEPTH: 26.5 HEIGHT: 34.0 SEAT WIDTH: 18.0 SEAT DEPTH: 16.0 SEAT HEIGHT: 16.0-20.5 BACK WIDTH: 18.0 BACK HEIGHT: 17.5 COM: 0.5 YD COL: 3.91 SQ FT WEIGHT: 28.0 LB			
1133	B1	BASIC TASK ARMED Plastic back with upholstered seat	A53	561 583 606 636 671 706 736 711 761 831	<ul style="list-style-type: none"> • 360° swivel • Pneumatic cylinder height adjustment • Arms coordinate with the frame color • Stool options available for \$125 upcharge. See stool option section. 	WIDTH: 26.5 DEPTH: 26.5 HEIGHT: 33.5 SEAT WIDTH: 18.0 SEAT DEPTH: 16.0 SEAT HEIGHT: 16.0-20.5 BACK WIDTH: 18.0 BACK HEIGHT: 17.5 COM: 0.5 YD COL: 3.91 SQ FT WEIGHT: 28.0 LB			
1132	S3	SWIVEL TILT ARMLESS Plastic back with upholstered seat	A00	541 563 586 616 651 686 716 691 741 811	<ul style="list-style-type: none"> • Upright lock • Center knob tension adjustment • 360° swivel • Pneumatic cylinder height adjustment • Stool options available for \$125 upcharge. See stool option section. 	WIDTH: 26.5 DEPTH: 26.5 HEIGHT: 39.0 SEAT WIDTH: 18.0 SEAT DEPTH: 16.5 SEAT HEIGHT: 21.0 BACK WIDTH: 18.0 BACK HEIGHT: 17.5 COM: 0.5 YD COL: 3.91 SQ FT WEIGHT: 17.5 LB			
1133	S3	SWIVEL TILT ARMED Plastic back with upholstered seat	A53	596 618 641 671 706 741 771 746 796 866	<ul style="list-style-type: none"> • Upright lock • Center knob tension adjustment • 360° swivel • Pneumatic cylinder height adjustment • Arms coordinate with the frame color 	WIDTH: 26.5 DEPTH: 26.5 HEIGHT: 39.0 SEAT WIDTH: 18.0 SEAT DEPTH: 16.5 SEAT HEIGHT: 21.0 BACK WIDTH: 18.0 BACK HEIGHT: 17.5 COM: 0.5 YD COL: 3.91 SQ FT WEIGHT: 17.5 LB			
1132	R2	ROCKING TILT ARMLESS Plastic back with upholstered seat	A00	596 618 641 671 706 741 771 746 796 866	<ul style="list-style-type: none"> • Rock left, right, front and back • 360° swivel • Pneumatic cylinder height adjustment 	WIDTH: 26.5 DEPTH: 26.5 HEIGHT: 39.0 SEAT WIDTH: 18.0 SEAT DEPTH: 17.0 SEAT HEIGHT: 21.5 BACK WIDTH: 18.0 BACK HEIGHT: 17.5 COM: 0.72 SQ FT COL: 3.91 SQ FT WEIGHT: 26.0 LB			
1133	R2	ROCKING TILT ARMED Plastic back with upholstered seat	A53	651 673 696 726 761 796 826 801 851 921	<ul style="list-style-type: none"> • Rock left, right, front and back • 360° swivel • Pneumatic cylinder height adjustment • Arms coordinate with the frame color 	WIDTH: 26.5 DEPTH: 26.5 HEIGHT: 39.0 SEAT WIDTH: 18.0 SEAT DEPTH: 17.0 SEAT HEIGHT: 21.5 BACK WIDTH: 18.0 BACK HEIGHT: 17.5 COM: 0.5 YD COL: 3.91 SQ FT WEIGHT: 24.5 LB			

ARM OPTIONS



Nylon Fixed Arm for 4 leg models
A53B - Black
A53G - Cloud Gray

BASE OPTIONS



27" Mid-Profile Nylon Base
BA11B - Black
BA11D - Graphite



27" Mid-Profile Aluminum Base
BA12B - Black Powder Coat
BA12P - Polished
BA12S - Silver Powder Coat

STOOL OPTIONS



CY30B - 8" Stool
(Seat Height: 22"-30")
Use for work surfaces up to 36"



CY36B - 10" Stool
(Seat Height: 25"-36")
Use for work surfaces up to 42"

FRAME COLORS

BLACK BF	SILVER SF
-------------	--------------

PLASTIC COLORS

BLACK SWAN P01	WHITE WHISPER P05	FEDERAL BLUE P11	CRIMSON RED P12	LEMON YELLOW P13	DOVE GRAY P14
CLOUD GRAY P15	LAGOON BLUE P16	APPLE GREEN P17	TANGERINE ORANGE P18	LATTE P19	AZURE BLUE P20

(BACK AND SEAT)

diddy

dazzle your conference space

GSA SIN # 33721

- Conference and guest seating
- Fixed wraparound arms
- Polished aluminum base standard
- Warranted to 300 lbs.



CREATING DIDDY MODEL NUMBER

MODEL NUMBER CONTROL ARMS GRADE BASE CASTERS PACKAGING

2 4 5 0 - [] [] - A [] [] - [] [] - B A [] [] - C [] [] - [] []

* FOR ARMLESS USE CODE ADD * IF CASTER MODEL NUMBERS ARE LEFT BLANK THEN STANDARD OPTION WILL BE ASSUMED

PACKAGING NOTES

CODE	DESCRIPTION	LIST UPCHARGE
AB	ASSEMBLED IN BAG	\$0
BAC	BACK ASSEMBLED IN CARTON	\$0

MID-BACK

MODEL	CONTROL	DESCRIPTION	ARM	FABRIC/LEATHER	FEATURES	DIMENSIONS	ARM OPTIONS																															
2450	B1	MID-BACK BASIC TASK	A00	<table border="1"> <thead> <tr> <th>A</th> <th>B/COM</th> <th>C</th> <th>D</th> <th>E</th> <th>F</th> <th>G</th> <th>L3/COL</th> <th>L4</th> <th>L5</th> </tr> </thead> <tbody> <tr> <td>796</td> <td>856</td> <td>896</td> <td>946</td> <td>1016</td> <td>1091</td> <td>1166</td> <td>971</td> <td>1001</td> <td>1271</td> </tr> <tr> <td>A24</td> <td>931</td> <td>991</td> <td>1031</td> <td>1081</td> <td>1151</td> <td>1226</td> <td>1301</td> <td>1106</td> <td>1136</td> <td>1406</td> </tr> </tbody> </table>	A	B/COM	C	D	E	F	G	L3/COL	L4	L5	796	856	896	946	1016	1091	1166	971	1001	1271	A24	931	991	1031	1081	1151	1226	1301	1106	1136	1406	<ul style="list-style-type: none"> • 360° swivel • Pneumatic cylinder height adjustment 	<p>WIDTH: 21.5</p> <p>DEPTH: 27.5</p> <p>HEIGHT: 31.5-36.0</p> <p>SEAT WIDTH: 19.0</p> <p>SEAT DEPTH: 18.0</p> <p>SEAT HEIGHT: 16.5-21.5</p> <p>BACK WIDTH: 18.0</p> <p>BACK HEIGHT: 16.5</p> <p>COM: 2.0 YD</p> <p>COL: 19.0 SQ FT</p> <p>WEIGHT: 31.0 LB</p>	<p>A24B/C \$135</p> <p>Fixed Wraparound Arm A24B - Black A24C - Chrome</p>
A	B/COM		C	D	E	F	G	L3/COL	L4	L5																												
796	856		896	946	1016	1091	1166	971	1001	1271																												
A24	931	991	1031	1081	1151	1226	1301	1106	1136	1406																												
2450	S3	MID-BACK SWIVEL TILT	A00	<table border="1"> <thead> <tr> <th>A</th> <th>B/COM</th> <th>C</th> <th>D</th> <th>E</th> <th>F</th> <th>G</th> <th>L3/COL</th> <th>L4</th> <th>L5</th> </tr> </thead> <tbody> <tr> <td>831</td> <td>891</td> <td>931</td> <td>981</td> <td>1051</td> <td>1126</td> <td>1201</td> <td>1006</td> <td>1036</td> <td>1306</td> </tr> <tr> <td>A24</td> <td>966</td> <td>1026</td> <td>1066</td> <td>1116</td> <td>1186</td> <td>1261</td> <td>1336</td> <td>1141</td> <td>1171</td> <td>1441</td> </tr> </tbody> </table>	A	B/COM	C	D	E	F	G	L3/COL	L4	L5	831	891	931	981	1051	1126	1201	1006	1036	1306	A24	966	1026	1066	1116	1186	1261	1336	1141	1171	1441	<ul style="list-style-type: none"> • Upright lock • Center knob tension adjustment • 360° swivel • Pneumatic cylinder height adjustment 	<p>WIDTH: 21.5</p> <p>DEPTH: 27.5</p> <p>HEIGHT: 31.50-36.0</p> <p>SEAT WIDTH: 19.0</p> <p>SEAT DEPTH: 18.0</p> <p>SEAT HEIGHT: 17.0-21.5</p> <p>BACK WIDTH: 18.0</p> <p>BACK HEIGHT: 16.5</p> <p>COM: 2.0 YD</p> <p>COL: 19.0 SQ FT</p> <p>WEIGHT: 31.0 LB</p>	<p>BA12B/P/S STD</p> <p>27" Mid-Profile Aluminum Base BA12B - Black BA12P - Polished BA12S - Silver (C7 Chrome-Accented Casters Standard with Polished Base)</p> <p>BA14P STD</p> <p>26" High Profile Aluminum Base - Polished</p>
A	B/COM		C	D	E	F	G	L3/COL	L4	L5																												
831	891		931	981	1051	1126	1201	1006	1036	1306																												
A24	966	1026	1066	1116	1186	1261	1336	1141	1171	1441																												
2450	R2	MID-BACK ROCKING TILT	A00	<table border="1"> <thead> <tr> <th>A</th> <th>B/COM</th> <th>C</th> <th>D</th> <th>E</th> <th>F</th> <th>G</th> <th>L3/COL</th> <th>L4</th> <th>L5</th> </tr> </thead> <tbody> <tr> <td>901</td> <td>961</td> <td>1001</td> <td>1051</td> <td>1121</td> <td>1196</td> <td>1271</td> <td>1076</td> <td>1106</td> <td>1376</td> </tr> <tr> <td>A24</td> <td>1036</td> <td>1096</td> <td>1136</td> <td>1186</td> <td>1256</td> <td>1331</td> <td>1406</td> <td>1211</td> <td>1241</td> <td>1511</td> </tr> </tbody> </table>	A	B/COM	C	D	E	F	G	L3/COL	L4	L5	901	961	1001	1051	1121	1196	1271	1076	1106	1376	A24	1036	1096	1136	1186	1256	1331	1406	1211	1241	1511	<ul style="list-style-type: none"> • Polished aluminum 4-star base with glides or 5-star base with casters • Rock left, right, front and back • 360° swivel • Pneumatic cylinder height adjustment 	<p>WIDTH: 21.5</p> <p>DEPTH: 27.5</p> <p>HEIGHT: 32.0-36.5</p> <p>SEAT WIDTH: 19.0</p> <p>SEAT DEPTH: 18.0</p> <p>SEAT HEIGHT: 17-21.5</p> <p>BACK WIDTH: 18.0</p> <p>BACK HEIGHT: 16.5</p> <p>COM: 2.0 YD</p> <p>COL: 19.0 SQ FT</p> <p>WEIGHT: 31.0 LB</p>	<p>C7 STD</p> <p>Chrome-Accented Hard Floor and Carpet Casters (Standard with Polished Base)</p> <p>C6 N/C</p> <p>Large Diameter Carpet Casters</p> <p>C6S \$35</p> <p>Large Diameter Hard Floor and Carpet Casters</p>
A	B/COM		C	D	E	F	G	L3/COL	L4	L5																												
901	961		1001	1051	1121	1196	1271	1076	1106	1376																												
A24	1036	1096	1136	1186	1256	1331	1406	1211	1241	1511																												
2450	GT	MID-BACK GUEST	A00	<table border="1"> <thead> <tr> <th>A</th> <th>B/COM</th> <th>C</th> <th>D</th> <th>E</th> <th>F</th> <th>G</th> <th>L3/COL</th> <th>L4</th> <th>L5</th> </tr> </thead> <tbody> <tr> <td>866</td> <td>926</td> <td>966</td> <td>1016</td> <td>1086</td> <td>1161</td> <td>1236</td> <td>1041</td> <td>1071</td> <td>1341</td> </tr> <tr> <td>A24</td> <td>1001</td> <td>1061</td> <td>1101</td> <td>1151</td> <td>1221</td> <td>1296</td> <td>1371</td> <td>1176</td> <td>1206</td> <td>1476</td> </tr> </tbody> </table>	A	B/COM	C	D	E	F	G	L3/COL	L4	L5	866	926	966	1016	1086	1161	1236	1041	1071	1341	A24	1001	1061	1101	1151	1221	1296	1371	1176	1206	1476	<ul style="list-style-type: none"> • Polished aluminum 4-star base with glides or 5-star base with casters • 360° swivel • Fixed height 	<p>WIDTH: 21.5</p> <p>DEPTH: 27.5</p> <p>HEIGHT: 33.0</p> <p>SEAT WIDTH: 19.0</p> <p>SEAT DEPTH: 18.0</p> <p>SEAT HEIGHT: 18.0</p> <p>BACK WIDTH: 18.0</p> <p>BACK HEIGHT: 16.5</p> <p>COM: 2.0 YD</p> <p>COL: 19.0 SQ FT</p> <p>WEIGHT: 31.0 LB</p>	
A	B/COM		C	D	E	F	G	L3/COL	L4	L5																												
866	926		966	1016	1086	1161	1236	1041	1071	1341																												
A24	1001	1061	1101	1151	1221	1296	1371	1176	1206	1476																												

GSA SIN # 33721 PENDING

- Synergy of simple form and functionality
- Combines lounge comfort with ergonomic function
- Mid-back or high-back options
- 5-star, 4-star or wire bases
- Multiple upholstery options
- Warranted to 300 lbs.

MID-BACK

CREATING ELLIE MODEL NUMBER

MODEL NUMBER CONTROL GRADE BASE CASTERS PACKAGING OPTIONS

9 3 6 0 - R - - B A - - C - - - - -

* IF CASTER MODEL NUMBERS ARE LEFT BLANK THEN STANDARD OPTION WILL BE ASSUMED

PACKAGING NOTES

CODE	DESCRIPTION	LIST UPCHARGE
AB	ASSEMBLED IN BAG	\$0
BAC	BACK ASSEMBLED IN CARTON	\$0

MODEL	BASE	CONTROL	DESCRIPTION	FABRIC/LEATHER*	FEATURES	DIMENSIONS														
9360	BA22	R4	MID-BACK 5-STAR BASE	<table border="1"> <thead> <tr> <th>A</th> <th>B/COM</th> <th>C</th> <th>D</th> <th>E</th> <th>F</th> <th>G</th> </tr> </thead> <tbody> <tr> <td>1481</td> <td>1541</td> <td>1586</td> <td>1639</td> <td>1741</td> <td>1831</td> <td>1921</td> </tr> </tbody> </table>	A	B/COM	C	D	E	F	G	1481	1541	1586	1639	1741	1831	1921	<ul style="list-style-type: none"> • Black or gray 5-star base • Two-tone upholstery option • 360° swivel • Pneumatic cylinder height adjustment • Upright tilt lock • Carpet casters standard and glides optional 	<p>WIDTH: 27.0 DEPTH: 24.0 HEIGHT: 38.0 SEAT WIDTH: 17.0 SEAT DEPTH: 17.0 SEAT HEIGHT: 16.0-21.5 BACK WIDTH: 18.0 BACK HEIGHT: 19.5 WEIGHT: 27.0 LB COM: 2.0 YD</p>
A	B/COM	C	D	E	F	G														
1481	1541	1586	1639	1741	1831	1921														
9360	BA23	R5	MID-BACK 4-STAR BASE	<table border="1"> <thead> <tr> <th>A</th> <th>B/COM</th> <th>C</th> <th>D</th> <th>E</th> <th>F</th> <th>G</th> </tr> </thead> <tbody> <tr> <td>1789</td> <td>1849</td> <td>1894</td> <td>1947</td> <td>2049</td> <td>2139</td> <td>2229</td> </tr> </tbody> </table>	A	B/COM	C	D	E	F	G	1789	1849	1894	1947	2049	2139	2229	<ul style="list-style-type: none"> • Black, polished or white 4-star base • Two-tone upholstery option • 360° swivel • Upright tilt lock • Fixed seat height • Carpet casters standard and glides optional 	<p>WIDTH: 27.0 DEPTH: 24.0 HEIGHT: 38.0 SEAT WIDTH: 17.0 SEAT DEPTH: 17.0 SEAT HEIGHT: 18.5 BACK WIDTH: 18.0 BACK HEIGHT: 19.5 WEIGHT: 27.0 LB COM: 2.0 YD</p>
A	B/COM	C	D	E	F	G														
1789	1849	1894	1947	2049	2139	2229														
9360	BA24	R5	MID-BACK WIRE BASE	<table border="1"> <thead> <tr> <th>A</th> <th>B/COM</th> <th>C</th> <th>D</th> <th>E</th> <th>F</th> <th>G</th> </tr> </thead> <tbody> <tr> <td>2101</td> <td>2161</td> <td>2206</td> <td>2259</td> <td>2361</td> <td>2451</td> <td>2541</td> </tr> </tbody> </table>	A	B/COM	C	D	E	F	G	2101	2161	2206	2259	2361	2451	2541	<ul style="list-style-type: none"> • Black, Silver, Dover Gray or wire base • Two-tone upholstery option • 360° swivel • Upright tilt lock • Fixed seat height • Glides standard 	<p>WIDTH: 27.0 DEPTH: 24.0 HEIGHT: 38.0 SEAT WIDTH: 17.0 SEAT DEPTH: 17.0 SEAT HEIGHT: 18.5 BACK WIDTH: 18.0 BACK HEIGHT: 19.5 WEIGHT: 27.0 LB COM: 2.0 YD</p>
A	B/COM	C	D	E	F	G														
2101	2161	2206	2259	2361	2451	2541														

*Leather, vinyl or polyurethane textiles not approved for upholstery

BASE OPTIONS



BA22B/G
STD

26" Mid-Profile 5-Star Nylon Base
BA22B - Black
BA22G - Gray



BA23B/P/W
STD

29" High-Profile 4-Star Aluminum Base
BA23B - Black
BA23P - Polished
BA23W - White



BA24B/G/S
STD

31" Wire Base
BA24B - Black
BA24G - Dover Gray
BA24S - Silver

CASTER OPTIONS



C6S
\$35

Large Diameter Hard Floor and Carpet Casters-Black



C10G
STD

Large Diameter Carpet Casters Gray (Large Diameter Carpet Casters-Gray)



C10GS
\$35

Large Diameter Hard Floor and Carpet Casters-Gray

ADDITIONAL OPTIONS



G22BF/GF
\$30

Stationary Glide - Felt
G22BF - Black
G22GF - Gray
(Optional with 5-Star or 4-Star Base)



G22BT/GT
\$30

Stationary Glide - Teflon
G22BT - Black
G22GT - Gray
(Optional with 5-Star or 4-Star Base)



G23F/T
STD

Stationary Glide - Felt/Teflon
G23F - Felt
G23T - Teflon
(Standard with Wire Base)



STD

Standard Single Upholstery



TT
\$100*

Two-Tone Upholstery
*If the two upholstery selections are of different grades, the chair will price at the higher of the two grades.



AR
\$100

Arm Rest Upholstery
Select a different textile for the arm rests.
Coated Textiles Available: From the 9to5 Seating Nautilus Card-Pauly, Ace, Vintner and Delta.

ellie
comfort made elegant

GSA SIN # 33721 PENDING

- Synergy of simple form and functionality
- Combines lounge comfort with ergonomic function
- Mid-back or high-back options
- 5-star, 4-star or wire bases
- Multiple upholstery options
- Warranted to 300 lbs.

HIGH-BACK

CREATING ELLIE MODEL NUMBER

MODEL NUMBER CONTROL GRADE BASE CASTERS PACKAGING OPTIONS
9 3 8 0 - R - - B A - - C - - - - - - - -

* IF CASTER MODEL NUMBERS ARE LEFT BLANK THEN STANDARD OPTION WILL BE ASSUMED

PACKAGING NOTES

CODE	DESCRIPTION	LIST UPCHARGE
AB	ASSEMBLED IN BAG	\$0
BAC	BACK ASSEMBLED IN CARTON	\$0

MODEL	BASE	CONTROL	DESCRIPTION	FABRIC/LEATHER*	FEATURES	DIMENSIONS														
9380	BA22	R4	HIGH-BACK 5-STAR BASE	<table border="1"> <thead> <tr> <th>A</th> <th>B/COM</th> <th>C</th> <th>D</th> <th>E</th> <th>F</th> <th>G</th> </tr> </thead> <tbody> <tr> <td>1531</td> <td>1591</td> <td>1636</td> <td>1689</td> <td>1791</td> <td>1881</td> <td>1971</td> </tr> </tbody> </table>	A	B/COM	C	D	E	F	G	1531	1591	1636	1689	1791	1881	1971	<ul style="list-style-type: none"> • Black or gray 5-star base • Two-tone upholstery option • 360° swivel • Pneumatic cylinder height adjustment • Upright tilt lock • Carpet casters standard and glides optional 	<p>WIDTH: 27.0 DEPTH: 24.0 HEIGHT: 42.5 SEAT WIDTH: 17.0 SEAT DEPTH: 17.0 SEAT HEIGHT: 16.0-21.5 BACK WIDTH: 18.0 BACK HEIGHT: 24.5 WEIGHT: 29.0 LB COM: 2.2 YD</p>
A	B/COM	C	D	E	F	G														
1531	1591	1636	1689	1791	1881	1971														
9380	BA23	R5	HIGH-BACK 4-STAR BASE	<table border="1"> <thead> <tr> <th>A</th> <th>B/COM</th> <th>C</th> <th>D</th> <th>E</th> <th>F</th> <th>G</th> </tr> </thead> <tbody> <tr> <td>1839</td> <td>1899</td> <td>1944</td> <td>1997</td> <td>2099</td> <td>2189</td> <td>2279</td> </tr> </tbody> </table>	A	B/COM	C	D	E	F	G	1839	1899	1944	1997	2099	2189	2279	<ul style="list-style-type: none"> • Black, polished or white 4-star base • Two-tone upholstery option • 360° swivel • Upright tilt lock • Fixed seat height • Carpet casters standard and glides optional 	<p>WIDTH: 27.0 DEPTH: 24.0 HEIGHT: 42.5 SEAT WIDTH: 17.0 SEAT DEPTH: 17.0 SEAT HEIGHT: 18.5 BACK WIDTH: 18.0 BACK HEIGHT: 19.5 WEIGHT: 27.0 LB COM: 2.2 YD</p>
A	B/COM	C	D	E	F	G														
1839	1899	1944	1997	2099	2189	2279														
9380	BA24	R5	HIGH-BACK WIRE BASE	<table border="1"> <thead> <tr> <th>A</th> <th>B/COM</th> <th>C</th> <th>D</th> <th>E</th> <th>F</th> <th>G</th> </tr> </thead> <tbody> <tr> <td>2151</td> <td>2211</td> <td>2256</td> <td>2309</td> <td>2411</td> <td>2501</td> <td>2591</td> </tr> </tbody> </table>	A	B/COM	C	D	E	F	G	2151	2211	2256	2309	2411	2501	2591	<ul style="list-style-type: none"> • Black, Silver, Dover Gray or wire base • Two-tone upholstery option • 360° swivel • Upright tilt lock • Fixed seat height • Glides standard 	<p>WIDTH: 27.0 DEPTH: 24.0 HEIGHT: 42.5 SEAT WIDTH: 17.0 SEAT DEPTH: 17.0 SEAT HEIGHT: 18.5 BACK WIDTH: 18.0 BACK HEIGHT: 19.5 WEIGHT: 27.0 LB COM: 2.2 YD</p>
A	B/COM	C	D	E	F	G														
2151	2211	2256	2309	2411	2501	2591														

*Leather, vinyl or polyurethane textiles not approved for upholstery

BASE OPTIONS

BA22B/G
STD

26" Mid-Profile 5-Star Nylon Base
BA22B - Black
BA22G - Gray

BA23B/P/W
STD

29" High-Profile 4-Star Aluminum Base
BA23B - Black
BA23P - Polished
BA23W - White

BA24B/G/S
STD

31" Wire Base
BA24B - Black
BA24G - Dover Gray
BA24S - Silver

CASTER OPTIONS

C6S
\$35

Large Diameter Hard Floor and Carpet Casters-Black

C10G
STD

Large Diameter Carpet Casters Gray (Large Diameter Carpet Casters-Gray)

C10GS
\$35

Large Diameter Hard Floor and Carpet Casters-Gray

ADDITIONAL OPTIONS

G22BF/GF
\$30

Stationary Glide - Felt
G22BF - Black
G22GF - Gray
(Optional with 5-Star or 4-Star Base)

G22BT/GT
\$30

Stationary Glide - Teflon
G22BT - Black
G22GT - Gray
(Optional with 5-Star or 4-Star Base)

G23F/T
STD

Stationary Glide - Felt/Teflon
G23F - Felt
G23T - Teflon
(Standard with Wire Base)

TT
\$100*

Two-Tone Upholstery
*If the two upholstery selections are of different grades, the chair will price at the higher of the two grades.

AR
\$100

Arm Rest Upholstery
Select a different textile for the arm rests.
Coated Textiles Available: From the 9to5 Seating Nautilus Card-Pauly, Ace, Vintner and Delta.

STD

Standard Single Upholstery

HÅG capisco

human-centered design

GSA SIN # 33721

- Task, stool, conference and executive seating
- HÅG in Balance® (balanced, flowing tilt function)
- Seat slider standard (not available on 8105)
- Height-adjustable back standard (not available on 8105)
- Suitable for all work surfaces of 28" and higher
- Multiple cylinder heights and ranges
- Optional coordinating foot ring
- Headrest available on 8106
- Warranted to 300 lbs.



CREATING HÅG CAPISCO MODEL NUMBER

MODEL NUMBER CONTROL FINISH GRADE CYLINDER BASE CASTERS PACKAGING OPTIONS

8 1 - - F - - C Y - - B A 2 1 - C - - - -

PACKAGING NOTES

CODE	DESCRIPTION	LIST UPCHARGE
AB	ASSEMBLED IN BAG	\$0
PAC	PARTIALLY ASSEMBLED IN CARTON	\$0

MODEL 8106 R3

DESCRIPTION

**SADDLE SEAT
ROCKING TILT**

Upholstered back with upholstered seat

FABRIC/LEATHER

A	B/COM	C	D	E	F	G	L3/COL	L4	L5
1799	1844	1879	1924	2004	2099	2169	1964	1974	2074

- FEATURES**
- Upholstered saddle-shaped seat
 - Seat slider standard
 - 2-position tilt lock
 - Center knob tension adjustment
 - 360° swivel
 - Pneumatic seat height adjustment

DIMENSIONS

WIDTH: 29.0
DEPTH: 29.0
HEIGHT: CY23: 34.5-40.0
 CY29: 37.5-44.0
 CY37: 41.0-50.0

SEAT WIDTH: 18.5
SEAT DEPTH: 13.5-17.0
SEAT HEIGHT: CY23: 16.5-21.5
 CY29: 19.0-26.0
 CY37: 22.5-32.0

BACK WIDTH: 23.5
BACK HEIGHT: 16.0-19.5
COM: 1.25 YD
COL: 20.0 SQ FT
WEIGHT: 31.0 LB

FINISH COLORS

BLACK FINISH	SILVER FINISH	WHITE FINISH
BF	SF	WF

BASE OPTIONS

BA21B/S/W
STD

26" Low-Profile Aluminum Base with Curved/Arched Foot Plates
 BA21B - Black
 BA21S - Silver
 BA21W - White

CASTER OPTIONS

C1BS
STD

Hard Floor and Carpet Casters

C2BS
STD

Decompression Hard and Soft Carpet Casters

MODEL 8105 B4

DESCRIPTION

**SADDLE SEAT
STOOL**

Upholstered seat

FABRIC/LEATHER

A	B/COM	C	D	E	F	G	L3/COL	L4	L5
1364	1409	1444	1489	1569	1664	1734	1529	1539	1639

- FEATURES**
- Upholstered saddle-shaped seat
 - Center knob tension adjustment
 - 360° swivel
 - Pneumatic seat height adjustment

DIMENSIONS

WIDTH: 29.0
DEPTH: 29.0
HEIGHT: CY23: 16.5-21.5
 CY29: 19.0-26.0
 CY37: 22.5-32.0

SEAT WIDTH: 18.5
SEAT DEPTH: 13.5-17.0
SEAT HEIGHT: CY23: 16.5-21.5
 CY29: 19.0-26.0
 CY37: 22.5-32.0

BACK WIDTH: N/A
BACK HEIGHT: N/A
COM: 0.65 YD
COL: 12 SQ FT
WEIGHT: 24.5 LB

CYLINDER OPTIONS

CY23
STD

CY23 - Standard (Seat Height: 16.5-21.5)

CY29
STD

CY29 - Sit-to-Stand (Seat Height: 19.0-26.0)

CY37
STD

CY37 - Stool (Seat Height: 22.5-32.0)

MODEL 8126 R3

DESCRIPTION

**ROUND SEAT
ROCKING TILT**

Upholstered back with upholstered seat

FABRIC/LEATHER

A	B/COM	C	D	E	F	G	L3/COL	L4	L5
1835	1880	1915	1960	2040	2135	2205	2000	2010	2110

- FEATURES**
- Upholstered round-shaped seat
 - Seat slider standard
 - 2-position tilt lock
 - Center knob tension adjustment
 - 360° swivel
 - Pneumatic seat height adjustment

DIMENSIONS

WIDTH: 29.0
DEPTH: 29.0
HEIGHT: CY23: 34.5-40.0
 CY29: 37.5-44.0
 CY37: 41.0-50.0

SEAT WIDTH: 18.5
SEAT DEPTH: 13.5-17.0
SEAT HEIGHT: CY23: 16.5-21.5
 CY29: 19.0-26.0
 CY37: 22.5-32.0

BACK WIDTH: 23.43
BACK HEIGHT: 16.0-19.5
COM: 1.25 YD
COL: 20.0 SQ FT
WEIGHT: 31.0 LB

ADDITIONAL OPTIONS

FR18B/S/W
\$165

18" Foot Ring
 FR18B - Black
 FR18S - Silver
 FR18W - White

G1
\$30

Stationary Base Glide

NC

Two-Tone Contrasting Upholstery (seat and back)

*If the two upholstery selections are of different grades, the chair will price at the higher of the two grades.

**HRFB/S
HRLB/S**
*FABRIC: \$240
*LEATHER: \$255

Headrest
 HRFB - Fabric - Black
 HRFS - Fabric - Silver
 HRLB - Leather - Black
 HRLS - Leather - Silver

*Prices based on chair upholstery selection. Fabric grades A-G are \$240 and leather grades L3-L5 are \$255. Available for 8106 & 8126.

*Decompression caster is a safety feature to engage when the user is not seated in the chair. As the user lifts out of the chair, the caster prevents the chair from rolling away.

HÅG capisco puls

human-centered design

PLASTIC BACK

GSA SIN # 33721

- Task, stool, conference and executive seating
- HÅG in Balance® (balanced, flowing tilt function)
- Seat slider standard (not available for 8001 & 8002)
- Height-adjustable back standard (not available for 8001 & 8002)
- Seat and back available in 3 colors
- Suitable for all work surfaces of 28" and higher
- Multiple cylinder heights and ranges
- Optional coordinating foot ring
- Warranted to 300 lbs.



CREATING HÅG CAPISCO PULS MODEL NUMBER

MODEL NUMBER CONTROL PLASTIC FINISH GRADE CYLINDER BASE CASTERS PACKAGING OPTIONS

8 0 - P 4 - F - C Y - B A 2 1 - C

PACKAGING NOTES

CODE	DESCRIPTION	LIST UPCHARGE
AB	ASSEMBLED IN BAG	\$0
PAC	PARTIALLY ASSEMBLED IN CARTON	\$0

MODEL	DESCRIPTION	FABRIC	FEATURES	DIMENSIONS	FINISH COLORS	PLASTIC COLORS	BASE OPTIONS	CASTER OPTIONS																										
8010 R3	SADDLE SEAT ROCKING TILT Plastic back & seat with upholstered pad	<table border="1"> <thead> <tr> <th>A</th> <th>B/COM</th> <th>C</th> <th>D</th> <th>E</th> <th>F</th> <th>G</th> <th>L3/COL</th> <th>L4</th> <th>L5</th> </tr> </thead> <tbody> <tr> <td>1210</td> <td>1226</td> <td>1236</td> <td>1252</td> <td>1270</td> <td>1290</td> <td>1312</td> <td>1290</td> <td>1310</td> <td>1390</td> </tr> </tbody> </table>	A	B/COM	C	D	E	F	G	L3/COL	L4	L5	1210	1226	1236	1252	1270	1290	1312	1290	1310	1390	<ul style="list-style-type: none"> • Plastic saddle-shaped seat features upholstered pad • Seat slider standard • 2-position tilt lock • Center knob tension adjustment • 360° swivel • Pneumatic seat height adjustment 	<p>WIDTH: 29.0 DEPTH: 29.0 HEIGHT: CY23: 34.5-40.0 CY29: 37.5-44.0 CY37: 41.0-50.0</p> <p>SEAT WIDTH: 18.5 SEAT DEPTH: 13.5-17.0 SEAT HEIGHT: CY23: 16.5-21.5 CY29: 19.0-26.0 CY37: 22.5-32.0</p> <p>BACK WIDTH: 23.5 BACK HEIGHT: 16.0-19.5 COM: 0.6 YD COL: 2.0 SQ FT WEIGHT: 24.5 LB</p>	<table border="1"> <tr> <td>BLACK FINISH BF</td> <td>SILVER FINISH SF</td> <td>WHITE FINISH WF</td> </tr> </table>	BLACK FINISH BF	SILVER FINISH SF	WHITE FINISH WF	<table border="1"> <tr> <td>BLACK P40</td> <td>PETROLEUM P41</td> <td>LIGHT GRAY P42</td> </tr> </table>	BLACK P40	PETROLEUM P41	LIGHT GRAY P42	<p>BA21B/S/W STD 26" Low-Profile Aluminum Base with Curved/Arched Foot Plates BA21B - Black BA21S - Silver BA21W - White</p>	<p>C1BS STD Hard Floor and Carpet Casters</p> <p>C2BS STD Decompression Hard and Soft Carpet Casters</p>
A	B/COM	C	D	E	F	G	L3/COL	L4	L5																									
1210	1226	1236	1252	1270	1290	1312	1290	1310	1390																									
BLACK FINISH BF	SILVER FINISH SF	WHITE FINISH WF																																
BLACK P40	PETROLEUM P41	LIGHT GRAY P42																																
8020 R3	SADDLE SEAT ROCKING TILT Plastic back & seat with upholstered cushion	<table border="1"> <thead> <tr> <th>A</th> <th>B/COM</th> <th>C</th> <th>D</th> <th>E</th> <th>F</th> <th>G</th> </tr> </thead> <tbody> <tr> <td>1316</td> <td>1340</td> <td>1355</td> <td>1379</td> <td>1430</td> <td>1475</td> <td>1532</td> </tr> </tbody> </table>	A	B/COM	C	D	E	F	G	1316	1340	1355	1379	1430	1475	1532	<ul style="list-style-type: none"> • Plastic saddle-shaped seat features upholstered cushion • Removable seat cushion • Seat slider standard • 2-position tilt lock • Center knob tension adjustment • 360° swivel • Pneumatic seat height adjustment 	<p>WIDTH: 29.0 DEPTH: 29.0 HEIGHT: CY23: 34.5-40.0 CY29: 37.5-44.0 CY37: 41.0-50.0</p> <p>SEAT WIDTH: 18.5 SEAT DEPTH: 13.5-17.0 SEAT HEIGHT: CY23: 16.5-21.5 CY29: 19.0-26.0 CY37: 22.5-32.0</p> <p>BACK WIDTH: 23.5 BACK HEIGHT: 16.0-19.5 COM: 0.75 YD WEIGHT: 24.5 LB</p>	<table border="1"> <tr> <td>BLACK P40</td> <td>PETROLEUM P41</td> <td>LIGHT GRAY P42</td> </tr> </table>	BLACK P40	PETROLEUM P41	LIGHT GRAY P42	<p>BA21B/S/W STD 26" Low-Profile Aluminum Base with Curved/Arched Foot Plates BA21B - Black BA21S - Silver BA21W - White</p>	<p>C1BS STD Hard Floor and Carpet Casters</p> <p>C2BS STD Decompression Hard and Soft Carpet Casters</p>										
A	B/COM	C	D	E	F	G																												
1316	1340	1355	1379	1430	1475	1532																												
BLACK P40	PETROLEUM P41	LIGHT GRAY P42																																
8001 B4	SADDLE SEAT STOOL Upholstered seat pad	<table border="1"> <thead> <tr> <th>A</th> <th>B/COM</th> <th>C</th> <th>D</th> <th>E</th> <th>F</th> <th>G</th> <th>L3/COL</th> <th>L4</th> <th>L5</th> </tr> </thead> <tbody> <tr> <td>992</td> <td>1008</td> <td>1018</td> <td>1034</td> <td>1052</td> <td>1072</td> <td>1094</td> <td>1072</td> <td>1092</td> <td>1172</td> </tr> </tbody> </table>	A	B/COM	C	D	E	F	G	L3/COL	L4	L5	992	1008	1018	1034	1052	1072	1094	1072	1092	1172	<ul style="list-style-type: none"> • Plastic saddle-shaped seat features upholstered pad • Center knob tension adjustment • 360° swivel • Pneumatic seat height adjustment 	<p>WIDTH: 29.0 DEPTH: 29.0 HEIGHT: CY23: 16.5-21.5 CY29: 19.0-26.0 CY37: 22.5-32.0</p> <p>SEAT WIDTH: 18.5 SEAT DEPTH: 13.5-17.0 SEAT HEIGHT: CY23: 16.5-21.5 CY29: 19.0-26.0 CY37: 22.5-32.0</p> <p>BACK WIDTH: N/A BACK HEIGHT: N/A COM: 0.15 YD WEIGHT: 19.0 LB</p>	<table border="1"> <tr> <td>BLACK P40</td> <td>PETROLEUM P41</td> <td>LIGHT GRAY P42</td> </tr> </table>	BLACK P40	PETROLEUM P41	LIGHT GRAY P42	<p>CY23 STD CY23 - Standard (Seat Height: 16.5-21.5)</p> <p>CY29 STD CY29 - Sit-to-Stand (Seat Height: 19.0-26.0)</p> <p>CY37 STD CY37 - Stool (Seat Height: 22.5-32.0)</p>	<p>C1BS STD Hard Floor and Carpet Casters</p> <p>C2BS STD Decompression Hard and Soft Carpet Casters</p>				
A	B/COM	C	D	E	F	G	L3/COL	L4	L5																									
992	1008	1018	1034	1052	1072	1094	1072	1092	1172																									
BLACK P40	PETROLEUM P41	LIGHT GRAY P42																																
8002 B4	SADDLE SEAT STOOL Upholstered seat cushion	<table border="1"> <thead> <tr> <th>A</th> <th>B/COM</th> <th>C</th> <th>D</th> <th>E</th> <th>F</th> <th>G</th> </tr> </thead> <tbody> <tr> <td>1111</td> <td>1135</td> <td>1150</td> <td>1174</td> <td>1225</td> <td>1270</td> <td>1327</td> </tr> </tbody> </table>	A	B/COM	C	D	E	F	G	1111	1135	1150	1174	1225	1270	1327	<ul style="list-style-type: none"> • Plastic saddle-shaped seat features upholstered cushion • Removable seat cushion • Center knob tension adjustment • 360° swivel • Pneumatic seat height adjustment 	<p>WIDTH: 29.0 DEPTH: 29.0 HEIGHT: CY23: 16.5-21.5 CY29: 19.0-26.0 CY37: 22.5-32.0</p> <p>SEAT WIDTH: 18.5 SEAT DEPTH: 13.5-17.0 SEAT HEIGHT: CY23: 16.5-21.5 CY29: 19.0-26.0 CY37: 22.5-32.0</p> <p>BACK WIDTH: N/A BACK HEIGHT: N/A COM: 0.15 YD WEIGHT: 19.0 LB</p>	<table border="1"> <tr> <td>BLACK P40</td> <td>PETROLEUM P41</td> <td>LIGHT GRAY P42</td> </tr> </table>	BLACK P40	PETROLEUM P41	LIGHT GRAY P42	<p>FR18B/S/W \$165 18" Foot Ring FR18B - Black FR18S - Silver FR18W - White</p> <p>G1 \$30 Stationary Base Glide</p>	<p>C1BS STD Hard Floor and Carpet Casters</p> <p>C2BS STD Decompression Hard and Soft Carpet Casters</p>										
A	B/COM	C	D	E	F	G																												
1111	1135	1150	1174	1225	1270	1327																												
BLACK P40	PETROLEUM P41	LIGHT GRAY P42																																

*Decompression caster is a safety feature to engage when the user is not seated in the chair. As the user lifts out of the chair, the caster prevents the chair from rolling away.

HÅG celi

sustainable seating for dynamic workspaces

GSA SIN # 33721 PENDING

- Stacking, meeting, collaborative spaces
- Sturdy lightweight aluminum frame
- Armless or fixed arm
- Rocking motion of back and seat allow movement of legs and lower body
- All plastic, upholstered seat or fully upholstered models
- Mix or match plastic and aluminum colors
- Made with 76% recyclable materials
- Warranted to 300 lbs



CREATING HÅG CELI MODEL NUMBER

MODEL NUMBER CONTROL PLASTIC FRAME GRADE PACKAGING OPTIONS

1 1 5 0 - G T - P 4 - - - F - - - - -

PACKAGING NOTES

CODE	DESCRIPTION	LIST UPCHARGE
AB	ASSEMBLED IN BAG	\$0
AC	ASSEMBLED IN CARTON	\$0

HÅG Celi chairs ships 3 per carton

NEW STACKING AVAILABLE IN APRIL

MODEL	DESCRIPTION	ARM	PLASTIC / FABRIC
1150	GT		P
		A00	560
		A61	685

MODEL	DESCRIPTION	ARM	PLASTIC / FABRIC
1150	GT		A B/COM C D E F G L3 L4 L5
		A00	634 679 714 739 764 814 859 784 834 904
		A61	759 804 839 864 889 939 984 909 959 1029

MODEL	DESCRIPTION	ARM	PLASTIC / FABRIC
1150	GT		A B/COM C D E F G L3 L4 L5
		A00	760 840 880 910 950 1055 1110 1030 1080 1235
		A61	885 965 1005 1035 1075 1180 1235 1155 1205 1360

- ### FEATURES
- Rocking motion of back and seat allow movement of legs and lower body
 - Stacks 15 high on floor armed or armless and on optional dolly
 - Mix and match colors of arms and frame
 - Non-marring glides standard for carpet that match frame color
 - Felt glides for hard floor optional that match frame color

DIMENSIONS

WIDTH: 20.0
 DEPTH: 20.5
 HEIGHT: 33.0
 SEAT WIDTH: 17.0
 SEAT DEPTH: 16.5
 SEAT HEIGHT: 18.5
 BACK WIDTH: 17.0
 BACK HEIGHT: 15.0
 COM: N/A
 COL: N/A
 WEIGHT: 11.0 LB

- Rocking motion of back and seat allow movement of legs and lower body
- Stacks 12 high on floor armed or armless and on optional dolly
- Mix and match colors of arms and frame
- Non-marring glides standard for carpet that match frame color
- Felt glides for hard floor optional that match frame color

DIMENSIONS

WIDTH: 20.0
 DEPTH: 20.5
 HEIGHT: 33.0
 SEAT WIDTH: 17.0
 SEAT DEPTH: 16.5
 SEAT HEIGHT: 18.5
 BACK WIDTH: 17.0
 BACK HEIGHT: 15.0
 COM: 0.5
 COL: 1.92
 WEIGHT: 11.5 LB

- Rocking motion of back and seat allow movement of legs and lower body
- Stacks 12 high on floor armed or armless and on optional dolly
- Mix and match colors of arms and frame
- Non-marring glides standard for carpet that match frame color
- Felt glides for hard floor optional that match frame color

DIMENSIONS

WIDTH: 20.0
 DEPTH: 20.5
 HEIGHT: 33.0
 SEAT WIDTH: 17.0
 SEAT DEPTH: 16.5
 SEAT HEIGHT: 18.5
 BACK WIDTH: 17.0
 BACK HEIGHT: 15.0
 COM: 0.8
 COL: 3.36
 WEIGHT: 11.5 LB

ARM OPTION

A61
\$125

Aluminum Fixed arm
 Standard Lead Time Colors:
 Black (B), Raw (RW), Blueberry (BB), Blush Rose (R)
 Extended lead time colors:
 Silver(S)

ACCESSORIES

GC10
\$30

Ganging Clip - 1 Per Set
 Armless-To-Armless. Not Available For Armed Models.

DL6
\$699

Stacking Dolly Stacks up to 12 High.

ADDITIONAL OPTIONS

G24
STD

Nylon Glider For Carpet Or Soft Surface Floors
 Available colors: Black (B), Silver (S), Blueberry (BB), Blush Rose (R)

G24F
\$20

Felt Glide For Hard Surface Floors
 Available colors: Black (BF), Silver (SF), Blueberry (BBF), Blush Rose (RF)

PLASTIC COLORS

STANDARD LEAD TIME	BLACK P40	CROWBERRY P45	CHESTNUT P48	SLATE P49
EXTENDED LEAD TIME	WOOD AW			

CROWBERRY \$40 **CHESTNUT \$40**

FRAME AND ARM COLORS - ALUMINUM

STANDARD LEAD TIME	BLACK BF	RAW RWF	BLUEBERRY BBF	BLUSH ROSE RF
EXTENDED LEAD TIME	SILVER SF			

HÅG tion

harmonizing work and wellness

GSA SIN # 33721 PENDING

- Light task, conference and collaborative seating
- Designed for flexibility and to fit in any workspace
- Multiple plastic, aluminum colors and finishes
- Made with 75% recycled and renewable materials
- Multiple cylinder and seat height ranges
- Optional coordinating foot ring
- Warranted to 300 lbs



CREATING TION MODEL NUMBER



PACKAGING NOTES

CODE	DESCRIPTION	LIST UPCHARGE
AB	ASSEMBLED IN BAG	\$0
BAC	BACK ASSEMBLED IN CARTON	\$0

NEW LIGHT TASK - AVAILABLE IN FEBRUARY

MODEL	CONTROL	DESCRIPTION	ARM	FABRIC/LEATHER	FEATURES	DIMENSIONS																																																			
2100	R6	ROCKING TILT PLASTIC BACK WITH PLASTIC SEAT	A00 A60	STANDARD LEADTIME <table border="1"> <tr><th>P</th><td>600</td></tr> <tr><th>P</th><td>675</td></tr> </table> EXTENDED LEADTIME <table border="1"> <tr><th>P</th><td>637</td></tr> <tr><th>P</th><td>761</td></tr> </table>	P	600	P	675	P	637	P	761	<ul style="list-style-type: none"> • Upright tilt lock; 360 swivel • Pneumatic cylinder height adjustment • Plastic Colors Standard Lead Time: Black, Harvest, Moss and Crowberry • Plastic Colors Extended Lead Time: Mist, Blush Rose, Chestnut • Aluminum Colors Standard Lead Time: Black, White, Moss and Crowberry • Aluminum Colors Extended Lead Time: Silver, Blush Rose, and Polished 	WIDTH: 24.0 DEPTH: 24.5 HEIGHT: 26.0-31.5 SEAT WIDTH: 18.0 SEAT DEPTH: 17.0 SEAT HEIGHT: 16.0-21.5 BACK WIDTH: 18.5 BACK HEIGHT: 10.0 WEIGHT: 24.0 LB																																											
P	600																																																								
P	675																																																								
P	637																																																								
P	761																																																								
2100	R6	ROCKING TILT PLASTIC BACK WITH UPHOLSTERED SEAT	A00 A60	STANDARD LEADTIME <table border="1"> <tr><th>A</th><th>B/COM</th><th>C</th><th>D</th><th>E</th><th>F</th><th>G</th><th>L3</th><th>L4</th><th>L5</th></tr> <tr><td>688</td><td>726</td><td>763</td><td>778</td><td>843</td><td>888</td><td>923</td><td>838</td><td>888</td><td>958</td></tr> <tr><td>763</td><td>801</td><td>838</td><td>853</td><td>918</td><td>963</td><td>998</td><td>913</td><td>963</td><td>1033</td></tr> </table> EXTENDED LEADTIME <table border="1"> <tr><th>1</th><th>2</th><th>3</th><th>4</th><th>5</th><th>6</th><th>LEATHER</th></tr> <tr><td>754</td><td>770</td><td>797</td><td>828</td><td>860</td><td>989</td><td>1157</td></tr> <tr><td>878</td><td>894</td><td>921</td><td>952</td><td>984</td><td>1113</td><td>1281</td></tr> </table>	A	B/COM	C	D	E	F	G	L3	L4	L5	688	726	763	778	843	888	923	838	888	958	763	801	838	853	918	963	998	913	963	1033	1	2	3	4	5	6	LEATHER	754	770	797	828	860	989	1157	878	894	921	952	984	1113	1281	<ul style="list-style-type: none"> • Upright tilt lock; 360 swivel • Pneumatic cylinder height adjustment • Plastic Colors Standard Lead Time: Black, Harvest, Moss and Crowberry • Plastic Colors Extended Lead Time: Mist, Blush Rose, Chestnut • Aluminum Colors Standard Lead Time: Black, White, Moss and Crowberry • Aluminum Colors Extended Lead Time: Silver, Blush Rose, and Polished 	WIDTH: 24.0 DEPTH: 24.5 HEIGHT: 26.0-31.5 SEAT WIDTH: 18.0 SEAT DEPTH: 17.0 SEAT HEIGHT: 16.0-21.5 BACK WIDTH: 18.5 BACK HEIGHT: 10.0 WEIGHT: 24.0 LB COM: 0.7 YD COL: 2.5 SQ FT
A	B/COM	C	D	E	F	G	L3	L4	L5																																																
688	726	763	778	843	888	923	838	888	958																																																
763	801	838	853	918	963	998	913	963	1033																																																
1	2	3	4	5	6	LEATHER																																																			
754	770	797	828	860	989	1157																																																			
878	894	921	952	984	1113	1281																																																			
2100	R6	ROCKING TILT UPHOLSTERED BACK WITH UPHOLSTERED SEAT	A00 A60	STANDARD LEADTIME <table border="1"> <tr><th>A</th><th>B/COM</th><th>C</th><th>D</th><th>E</th><th>F</th><th>G</th><th>L3</th><th>L4</th><th>L5</th></tr> <tr><td>788</td><td>848</td><td>893</td><td>928</td><td>993</td><td>1128</td><td>1233</td><td>1068</td><td>1118</td><td>1288</td></tr> <tr><td>863</td><td>923</td><td>968</td><td>1003</td><td>1068</td><td>1203</td><td>1308</td><td>1143</td><td>1193</td><td>1363</td></tr> </table> EXTENDED LEADTIME <table border="1"> <tr><th>1</th><th>2</th><th>3</th><th>4</th><th>5</th><th>6</th><th>LEATHER</th></tr> <tr><td>822</td><td>840</td><td>869</td><td>905</td><td>938</td><td>1078</td><td>1262</td></tr> <tr><td>946</td><td>964</td><td>993</td><td>1029</td><td>1062</td><td>1202</td><td>1386</td></tr> </table>	A	B/COM	C	D	E	F	G	L3	L4	L5	788	848	893	928	993	1128	1233	1068	1118	1288	863	923	968	1003	1068	1203	1308	1143	1193	1363	1	2	3	4	5	6	LEATHER	822	840	869	905	938	1078	1262	946	964	993	1029	1062	1202	1386	<ul style="list-style-type: none"> • Upright tilt lock; 360 swivel • Pneumatic cylinder height adjustment • Plastic Colors Standard Lead Time: Black, Harvest, Moss and Crowberry • Plastic Colors Extended Lead Time: Mist, Blush Rose, Chestnut • Aluminum Colors Standard Lead Time: Black, White, Moss and Crowberry • Aluminum Colors Extended Lead Time: Silver, Blush Rose, and Polished 	WIDTH: 24.0 DEPTH: 24.5 HEIGHT: 26.0-31.5 SEAT WIDTH: 18.0 SEAT DEPTH: 17.0 SEAT HEIGHT: 16.0-21.5 BACK WIDTH: 18.5 BACK HEIGHT: 10.0 WEIGHT: 24.0 LB COM: 1.7 YD COL: 4.82 SQ FT
A	B/COM	C	D	E	F	G	L3	L4	L5																																																
788	848	893	928	993	1128	1233	1068	1118	1288																																																
863	923	968	1003	1068	1203	1308	1143	1193	1363																																																
1	2	3	4	5	6	LEATHER																																																			
822	840	869	905	938	1078	1262																																																			
946	964	993	1029	1062	1202	1386																																																			
2120	R6	ROCKING TILT WOOD BACK WITH WOOD SEAT	A00 A60	EXTENDED LEADTIME <table border="1"> <tr><th>W</th><td>1271</td></tr> <tr><th>W</th><td>1395</td></tr> </table>	W	1271	W	1395	<ul style="list-style-type: none"> • Upright tilt lock; 360 swivel • Pneumatic cylinder height adjustment • Ash wood with clear stain 	WIDTH: 24.0 DEPTH: 24.5 HEIGHT: 26.0-31.5 SEAT WIDTH: 18.0 SEAT DEPTH: 17.0 SEAT HEIGHT: 16.0-21.5 BACK WIDTH: 18.5 BACK HEIGHT: 10.0 WEIGHT: 30.5 LB																																															
W	1271																																																								
W	1395																																																								
2120	R6	ROCKING TILT WOOD BACK WITH UPHOLSTERED SEAT	A00 A60	EXTENDED LEADTIME <table border="1"> <tr><th>1</th><th>2</th><th>3</th><th>4</th><th>5</th><th>6</th><th>LEATHER</th></tr> <tr><td>1128</td><td>1151</td><td>1192</td><td>1239</td><td>1285</td><td>1477</td><td>1728</td></tr> <tr><td>1252</td><td>1275</td><td>1316</td><td>1363</td><td>1409</td><td>1601</td><td>1852</td></tr> </table>	1	2	3	4	5	6	LEATHER	1128	1151	1192	1239	1285	1477	1728	1252	1275	1316	1363	1409	1601	1852	<ul style="list-style-type: none"> • Upright tilt lock; 360 swivel • Pneumatic cylinder height adjustment • Ash wood with clear stain 	WIDTH: 24.0 DEPTH: 24.5 HEIGHT: 26.0-31.5 SEAT WIDTH: 18.0 SEAT DEPTH: 17.0 SEAT HEIGHT: 16.0-21.5 BACK WIDTH: 18.5 BACK HEIGHT: 10.0 WEIGHT: 30.5 LB COM: 0.6 YD COL: 2.5 SQ FT																														
1	2	3	4	5	6	LEATHER																																																			
1128	1151	1192	1239	1285	1477	1728																																																			
1252	1275	1316	1363	1409	1601	1852																																																			

ARM OPTIONS



Aluminum Fixed Arms
 Standard Lead Time Colors: Black (B), Moss (M), White (W), Tumbled (T) - \$125
 Extended Lead Time Colors: Silver (S), Blush Rose (R), Polished (P)

BASE OPTIONS



24.5" Low Profile Aluminum Base
 Standard Lead Time Colors: Black (B), Moss (M), White (W), Tumbled (T) - \$50
 Extended Lead Time Colors: Silver (S), Blush Rose (R), Polished (P)

CASTER OPTIONS



Large Diameter Hard Floor and Carpet Casters

BACK STEM OPTIONS

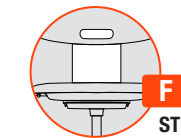

Aluminum Back Stem
 Standard Lead Time Colors: Black (BF), Moss (MF), Tumbled (TF), White (WF)
 Extended Lead Time Colors: Silver (SF), Blush Rose (RF), Polished (PF)

TWO TONE UPHOLSTERY

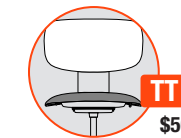

Two Tone Contrasting Upholstery (seat and back)
 * If the two upholstery selections are of different grades, the chair will price at the higher of the two grades.

ADDITIONAL OPTIONS



18" Foot Ring
 FR18B - Black
 FR18S - Silver
 FR18W - White

CYLINDER OPTIONS



Standard Height Cylinder-CY23
 Seat Height: 16.5"-21.5"

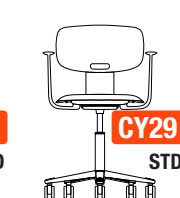

Sit to Stand Height Cylinder-CY29
 Seat Height: 19"-26"

Standard Lead Time Colors: Black (B), Moss (M), Silver (S), White (W)
 Extended Lead Time Colors: Blush Rose (R)

PLASTIC COLORS

STANDARD LEAD TIME	BLACK P40	HARVEST P43	MOSS P44	CROWBERRY P45
EXTENDED LEAD TIME	MIST P46	BLUSH ROSE P47	CHESTNUT P48	

BACK STEM, ARMS, BASE COLORS - ALUMINUM

STANDARD LEAD TIME	BLACK BF	WHITE WF	MOSS MF	TUMBLED TF
EXTENDED LEAD TIME	SILVER SF	BLUSH ROSE RF	POLISHED PF	

jax

reshaping comfort

GSA SIN # 33721

- Lounge, side and guest seating
- Modern, angular design
- Warranted to 300 lbs.



CREATING JAX MODEL NUMBER

MODEL NUMBER CONTROL BASE FINISH BASE OPTIONS CYLINDER GRADE OPTIONS PACKAGING

9 2 [] [] - L G - [] F - B A 2 0 [] [] [] [] - [] [] [] [] - [] [] [] [] - [] [] [] []

PACKAGING NOTES

CODE	DESCRIPTION	LIST UPCHARGE
AB	ASSEMBLED IN BAG	\$0
BAC	BACK ASSEMBLED IN CARTON	\$0
AC	ASSEMBLED IN CARTON	\$200

HIGH-BACK LOUNGE

MODEL	CONTROL	DESCRIPTION	FABRIC/LEATHER	FEATURES	DIMENSIONS	BASE FINISH														
9206	LG	WING-BACK LOUNGE CHAIR 4 METAL LEGS	<table border="1"> <thead> <tr> <th>A</th> <th>B/COM</th> <th>C</th> <th>D</th> <th>E</th> <th>F</th> <th>G</th> </tr> </thead> <tbody> <tr> <td>2079</td> <td>2164</td> <td>2229</td> <td>2309</td> <td>2454</td> <td>2594</td> <td>2709</td> </tr> </tbody> </table>	A	B/COM	C	D	E	F	G	2079	2164	2229	2309	2454	2594	2709	<ul style="list-style-type: none"> • Black or silver 4-leg base • Dome glides standard 	<p>WIDTH: 31.0 DEPTH: 30.0 HEIGHT: 45.5 SEAT WIDTH: 16.0 SEAT DEPTH: 18.5 SEAT HEIGHT: 17.0 BACK WIDTH: 23.5 BACK HEIGHT: 32.0 COM: 3.0 YD COL: 57.0 SQ FT WEIGHT: 48.0 LB</p>	<p>BA20P/B CY9N NC BA20P/B CY9NA \$50</p> <p>Aluminum Swivel Base BA20P - Polished BA20B - Black CY9N - Free Swivel CY9NA - Auto Return</p> <p>BF/SF NC BF/SF NC</p> <p>4 Leg BF - Black SF - Silver</p> <p>Wire Rod Leg BF - Black SF - Silver</p>
A	B/COM	C	D	E	F	G														
2079	2164	2229	2309	2454	2594	2709														
9216	LG	WING-BACK LOUNGE CHAIR WIRE ROD BASE	<table border="1"> <thead> <tr> <th>A</th> <th>B/COM</th> <th>C</th> <th>D</th> <th>E</th> <th>F</th> <th>G</th> </tr> </thead> <tbody> <tr> <td>2204</td> <td>2289</td> <td>2354</td> <td>2434</td> <td>2579</td> <td>2719</td> <td>2834</td> </tr> </tbody> </table>	A	B/COM	C	D	E	F	G	2204	2289	2354	2434	2579	2719	2834	<ul style="list-style-type: none"> • Black or silver wire rod base 	<p>WIDTH: 31.0 DEPTH: 30.0 HEIGHT: 45.5 SEAT WIDTH: 16.0 SEAT DEPTH: 18.5 SEAT HEIGHT: 17.0 BACK WIDTH: 23.5 BACK HEIGHT: 32.0 COM: 3.0 YD COL: 57.0 SQ FT WEIGHT: 48.0 LB</p>	<p>MS/WA NC</p> <p>Wood Leg Finishes MS - Maple WA - Walnut</p>
A	B/COM	C	D	E	F	G														
2204	2289	2354	2434	2579	2719	2834														
9236	LG	WING-BACK LOUNGE CHAIR SWIVEL BASE	<table border="1"> <thead> <tr> <th>A</th> <th>B/COM</th> <th>C</th> <th>D</th> <th>E</th> <th>F</th> <th>G</th> </tr> </thead> <tbody> <tr> <td>2254</td> <td>2339</td> <td>2404</td> <td>2484</td> <td>2629</td> <td>2769</td> <td>2884</td> </tr> </tbody> </table>	A	B/COM	C	D	E	F	G	2254	2339	2404	2484	2629	2769	2884	<ul style="list-style-type: none"> • Polished and black aluminum swivel base • Adjustable nylon glides standard • Optional auto-return cylinder 	<p>WIDTH: 31.0 DEPTH: 30.0 HEIGHT: 45.5 SEAT WIDTH: 16.0 SEAT DEPTH: 18.5 SEAT HEIGHT: 17.0 BACK WIDTH: 23.5 BACK HEIGHT: 32.0 COM: 3.0 YD COL: 57.0 SQ FT WEIGHT: 52.0 LB</p>	<p>G18 NC</p> <p>Dome Glide (9206 only)</p> <p>G8 \$20</p> <p>Swivel Steel Glide 4 per Set (9206 only)</p> <p>G9 \$20</p> <p>Swivel Nylon Glide 4 per Set (9206 only)</p> <p>G10 \$20</p> <p>Swivel Felt Glide 4 per Set (9206 only)</p> <p>G16 \$15</p> <p>Sled Base Clear Plastic Glide (9216 only) - 4 per set</p> <p>G17 \$25</p> <p>Sled Base Clear Plastic Glide with Felt (9216 only) - 4 per set</p>
A	B/COM	C	D	E	F	G														
2254	2339	2404	2484	2629	2769	2884														
9226	LG	WING-BACK LOUNGE CHAIR 4 WOOD LEGS	<table border="1"> <thead> <tr> <th>A</th> <th>B/COM</th> <th>C</th> <th>D</th> <th>E</th> <th>F</th> <th>G</th> </tr> </thead> <tbody> <tr> <td>2402</td> <td>2487</td> <td>2552</td> <td>2632</td> <td>2777</td> <td>2917</td> <td>3032</td> </tr> </tbody> </table>	A	B/COM	C	D	E	F	G	2402	2487	2552	2632	2777	2917	3032	<ul style="list-style-type: none"> • Maple or walnut finish legs • Two-tone upholstery available • Adjustable nylon glides standard 	<p>WIDTH: 31.0 DEPTH: 30.0 HEIGHT: 45.5 SEAT WIDTH: 16.0 SEAT DEPTH: 18.5 SEAT HEIGHT: 17.0 BACK WIDTH: 23.5 BACK HEIGHT: 32.0 COM: 3.0 YD COL: 57.0 SQ FT WEIGHT: 48.0 LB</p>	<p>TT \$100*</p> <p>Two Tone Contrasting Upholstery (seat and back)</p>
A	B/COM	C	D	E	F	G														
2402	2487	2552	2632	2777	2917	3032														

Certain textiles may require testing and approval before placing an order on Jax high-back lounge models. Please contact Customer Care for more information.

* If the two upholstery selections are of different grades, the chair will price at the higher of the two grades.

jax

reshaping comfort

GSA SIN # 33721

- Lounge, side and guest seating
- Modern, angular design
- Warranted to 300 lbs.



MID-BACK LOUNGE

CREATING JAX MODEL NUMBER

MODEL NUMBER CONTROL BASE FINISH BASE OPTIONS CYLINDER GRADE OPTIONS PACKAGING

9 2 [] [] - L G - [] F - B A 2 0 [] [] [] [] - [] [] [] [] - [] [] [] [] - [] [] [] []

PACKAGING NOTES

CODE	DESCRIPTION	LIST UPCHARGE
AB	ASSEMBLED IN BAG	\$0
BAC	BACK ASSEMBLED IN CARTON	\$0
AC	ASSEMBLED IN CARTON	\$200

MODEL	CONTROL	DESCRIPTION	FABRIC/LEATHER	FEATURES	DIMENSIONS	BASE FINISH	ADDITIONAL OPTIONS																																																																																												
9201	LG	MID-BACK LOUNGE CHAIR 4 METAL LEGS	<table border="1"> <thead> <tr> <th>A</th> <th>B/COM</th> <th>C</th> <th>D</th> <th>E</th> <th>F</th> <th>G</th> <th>L3/COL</th> <th>L4</th> </tr> </thead> <tbody> <tr> <td>1929</td> <td>2009</td> <td>2079</td> <td>2154</td> <td>2294</td> <td>2444</td> <td>2549</td> <td>2229</td> <td>2374</td> </tr> </tbody> </table>	A	B/COM	C	D	E	F	G	L3/COL	L4	1929	2009	2079	2154	2294	2444	2549	2229	2374	<ul style="list-style-type: none"> • Black or silver 4-leg base • Dome glides standard 	<p>WIDTH: 31.0 DEPTH: 28.0 HEIGHT: 32.5 SEAT WIDTH: 16.0 SEAT DEPTH: 18.5 SEAT HEIGHT: 17.0 BACK WIDTH: 23.5 BACK HEIGHT: 20.0 COM: 2.4 YD COL: 47.0 SQ FT WEIGHT: 32.0 LB</p>	<p>BA20P/B CY9N NC BA20P/B CY9NA \$50</p> <p>BF/SF NC BF/SF NC</p> <p>Aluminum Swivel Base BA20P - Polished BA20B - Black CY9N - Free Swivel CY9NA - Auto Return</p> <p>4 Leg BF - Black SF - Silver</p> <p>Wire Rod BF - Black SF - Silver</p>	9211	LG	MID-BACK LOUNGE CHAIR WIRE ROD BASE	<table border="1"> <thead> <tr> <th>A</th> <th>B/COM</th> <th>C</th> <th>D</th> <th>E</th> <th>F</th> <th>G</th> <th>L3/COL</th> <th>L4</th> </tr> </thead> <tbody> <tr> <td>2010</td> <td>2090</td> <td>2160</td> <td>2235</td> <td>2375</td> <td>2525</td> <td>2630</td> <td>2310</td> <td>2455</td> </tr> </tbody> </table>	A	B/COM	C	D	E	F	G	L3/COL	L4	2010	2090	2160	2235	2375	2525	2630	2310	2455	<ul style="list-style-type: none"> • Black or silver wire rod base • Optional glides available-G16 & G17 	<p>WIDTH: 31.0 DEPTH: 28.0 HEIGHT: 32.5 SEAT WIDTH: 16.0 SEAT DEPTH: 18.5 SEAT HEIGHT: 17.0 BACK WIDTH: 23.5 BACK HEIGHT: 20.0 COM: 2.4 YD COL: 47.0 SQ FT WEIGHT: 32.0 LB</p>	<p>MS/WA NC</p> <p>Wood Leg Finishes MS - Maple WA - Walnut</p>	9231	LG	MID-BACK LOUNGE CHAIR SWIVEL BASE	<table border="1"> <thead> <tr> <th>A</th> <th>B/COM</th> <th>C</th> <th>D</th> <th>E</th> <th>F</th> <th>G</th> <th>L3/COL</th> <th>L4</th> </tr> </thead> <tbody> <tr> <td>2108</td> <td>2188</td> <td>2258</td> <td>2333</td> <td>2473</td> <td>2623</td> <td>2728</td> <td>2408</td> <td>2553</td> </tr> </tbody> </table>	A	B/COM	C	D	E	F	G	L3/COL	L4	2108	2188	2258	2333	2473	2623	2728	2408	2553	<ul style="list-style-type: none"> • Polished and black aluminum swivel base • Adjustable nylon glides standard • Optional auto-return cylinder 	<p>WIDTH: 31.0 DEPTH: 28.0 HEIGHT: 32.5 SEAT WIDTH: 16.0 SEAT DEPTH: 18.5 SEAT HEIGHT: 17.0 BACK WIDTH: 23.5 BACK HEIGHT: 20.0 COM: 2.4 YD COL: 47.0 SQ FT WEIGHT: 34.0 LB</p>	<p>G18 NC G8 \$20 G9 \$20</p> <p>Dome Glide (9201 only)</p> <p>Swivel Steel Glide 4 per Set (9201 only)</p> <p>Swivel Nylon Glide 4 per Set (9201 only)</p> <p>G10 \$20 G16 \$15 G17 \$25</p> <p>Swivel Felt Glide 4 per Set (9201 only)</p> <p>Sled Base Clear Plastic Glide (9211 only) - 4 per set</p> <p>Sled Base Clear Plastic Glide with Felt (9211 only) - 4 per set</p>	9221	LG	MID-BACK LOUNGE CHAIR 4 WOOD LEGS	<table border="1"> <thead> <tr> <th>A</th> <th>B/COM</th> <th>C</th> <th>D</th> <th>E</th> <th>F</th> <th>G</th> <th>L3/COL</th> <th>L4</th> </tr> </thead> <tbody> <tr> <td>2252</td> <td>2332</td> <td>2402</td> <td>2477</td> <td>2617</td> <td>2767</td> <td>2872</td> <td>2552</td> <td>2697</td> </tr> </tbody> </table>	A	B/COM	C	D	E	F	G	L3/COL	L4	2252	2332	2402	2477	2617	2767	2872	2552	2697	<ul style="list-style-type: none"> • Maple or walnut finish legs • Two-tone upholstery available • Adjustable nylon glides standard 	<p>WIDTH: 31.0 DEPTH: 28.0 HEIGHT: 32.5 SEAT WIDTH: 16.0 SEAT DEPTH: 18.5 SEAT HEIGHT: 17.0 BACK WIDTH: 23.5 BACK HEIGHT: 20.0 COM: 2.4 YD COL: 47.0 SQ FT WEIGHT: 30.0 LB</p>	<p>TT \$100*</p> <p>Two Tone Contrasting Upholstery (seat and back)</p>
A	B/COM	C	D	E	F	G	L3/COL	L4																																																																																											
1929	2009	2079	2154	2294	2444	2549	2229	2374																																																																																											
9211	LG	MID-BACK LOUNGE CHAIR WIRE ROD BASE	<table border="1"> <thead> <tr> <th>A</th> <th>B/COM</th> <th>C</th> <th>D</th> <th>E</th> <th>F</th> <th>G</th> <th>L3/COL</th> <th>L4</th> </tr> </thead> <tbody> <tr> <td>2010</td> <td>2090</td> <td>2160</td> <td>2235</td> <td>2375</td> <td>2525</td> <td>2630</td> <td>2310</td> <td>2455</td> </tr> </tbody> </table>	A	B/COM	C	D	E	F	G	L3/COL	L4	2010	2090	2160	2235	2375	2525	2630	2310	2455	<ul style="list-style-type: none"> • Black or silver wire rod base • Optional glides available-G16 & G17 	<p>WIDTH: 31.0 DEPTH: 28.0 HEIGHT: 32.5 SEAT WIDTH: 16.0 SEAT DEPTH: 18.5 SEAT HEIGHT: 17.0 BACK WIDTH: 23.5 BACK HEIGHT: 20.0 COM: 2.4 YD COL: 47.0 SQ FT WEIGHT: 32.0 LB</p>	<p>MS/WA NC</p> <p>Wood Leg Finishes MS - Maple WA - Walnut</p>	9231	LG	MID-BACK LOUNGE CHAIR SWIVEL BASE	<table border="1"> <thead> <tr> <th>A</th> <th>B/COM</th> <th>C</th> <th>D</th> <th>E</th> <th>F</th> <th>G</th> <th>L3/COL</th> <th>L4</th> </tr> </thead> <tbody> <tr> <td>2108</td> <td>2188</td> <td>2258</td> <td>2333</td> <td>2473</td> <td>2623</td> <td>2728</td> <td>2408</td> <td>2553</td> </tr> </tbody> </table>	A	B/COM	C	D	E	F	G	L3/COL	L4	2108	2188	2258	2333	2473	2623	2728	2408	2553	<ul style="list-style-type: none"> • Polished and black aluminum swivel base • Adjustable nylon glides standard • Optional auto-return cylinder 	<p>WIDTH: 31.0 DEPTH: 28.0 HEIGHT: 32.5 SEAT WIDTH: 16.0 SEAT DEPTH: 18.5 SEAT HEIGHT: 17.0 BACK WIDTH: 23.5 BACK HEIGHT: 20.0 COM: 2.4 YD COL: 47.0 SQ FT WEIGHT: 34.0 LB</p>	<p>G18 NC G8 \$20 G9 \$20</p> <p>Dome Glide (9201 only)</p> <p>Swivel Steel Glide 4 per Set (9201 only)</p> <p>Swivel Nylon Glide 4 per Set (9201 only)</p> <p>G10 \$20 G16 \$15 G17 \$25</p> <p>Swivel Felt Glide 4 per Set (9201 only)</p> <p>Sled Base Clear Plastic Glide (9211 only) - 4 per set</p> <p>Sled Base Clear Plastic Glide with Felt (9211 only) - 4 per set</p>	9221	LG	MID-BACK LOUNGE CHAIR 4 WOOD LEGS	<table border="1"> <thead> <tr> <th>A</th> <th>B/COM</th> <th>C</th> <th>D</th> <th>E</th> <th>F</th> <th>G</th> <th>L3/COL</th> <th>L4</th> </tr> </thead> <tbody> <tr> <td>2252</td> <td>2332</td> <td>2402</td> <td>2477</td> <td>2617</td> <td>2767</td> <td>2872</td> <td>2552</td> <td>2697</td> </tr> </tbody> </table>	A	B/COM	C	D	E	F	G	L3/COL	L4	2252	2332	2402	2477	2617	2767	2872	2552	2697	<ul style="list-style-type: none"> • Maple or walnut finish legs • Two-tone upholstery available • Adjustable nylon glides standard 	<p>WIDTH: 31.0 DEPTH: 28.0 HEIGHT: 32.5 SEAT WIDTH: 16.0 SEAT DEPTH: 18.5 SEAT HEIGHT: 17.0 BACK WIDTH: 23.5 BACK HEIGHT: 20.0 COM: 2.4 YD COL: 47.0 SQ FT WEIGHT: 30.0 LB</p>	<p>TT \$100*</p> <p>Two Tone Contrasting Upholstery (seat and back)</p>																									
A	B/COM	C	D	E	F	G	L3/COL	L4																																																																																											
2010	2090	2160	2235	2375	2525	2630	2310	2455																																																																																											
9231	LG	MID-BACK LOUNGE CHAIR SWIVEL BASE	<table border="1"> <thead> <tr> <th>A</th> <th>B/COM</th> <th>C</th> <th>D</th> <th>E</th> <th>F</th> <th>G</th> <th>L3/COL</th> <th>L4</th> </tr> </thead> <tbody> <tr> <td>2108</td> <td>2188</td> <td>2258</td> <td>2333</td> <td>2473</td> <td>2623</td> <td>2728</td> <td>2408</td> <td>2553</td> </tr> </tbody> </table>	A	B/COM	C	D	E	F	G	L3/COL	L4	2108	2188	2258	2333	2473	2623	2728	2408	2553	<ul style="list-style-type: none"> • Polished and black aluminum swivel base • Adjustable nylon glides standard • Optional auto-return cylinder 	<p>WIDTH: 31.0 DEPTH: 28.0 HEIGHT: 32.5 SEAT WIDTH: 16.0 SEAT DEPTH: 18.5 SEAT HEIGHT: 17.0 BACK WIDTH: 23.5 BACK HEIGHT: 20.0 COM: 2.4 YD COL: 47.0 SQ FT WEIGHT: 34.0 LB</p>	<p>G18 NC G8 \$20 G9 \$20</p> <p>Dome Glide (9201 only)</p> <p>Swivel Steel Glide 4 per Set (9201 only)</p> <p>Swivel Nylon Glide 4 per Set (9201 only)</p> <p>G10 \$20 G16 \$15 G17 \$25</p> <p>Swivel Felt Glide 4 per Set (9201 only)</p> <p>Sled Base Clear Plastic Glide (9211 only) - 4 per set</p> <p>Sled Base Clear Plastic Glide with Felt (9211 only) - 4 per set</p>	9221	LG	MID-BACK LOUNGE CHAIR 4 WOOD LEGS	<table border="1"> <thead> <tr> <th>A</th> <th>B/COM</th> <th>C</th> <th>D</th> <th>E</th> <th>F</th> <th>G</th> <th>L3/COL</th> <th>L4</th> </tr> </thead> <tbody> <tr> <td>2252</td> <td>2332</td> <td>2402</td> <td>2477</td> <td>2617</td> <td>2767</td> <td>2872</td> <td>2552</td> <td>2697</td> </tr> </tbody> </table>	A	B/COM	C	D	E	F	G	L3/COL	L4	2252	2332	2402	2477	2617	2767	2872	2552	2697	<ul style="list-style-type: none"> • Maple or walnut finish legs • Two-tone upholstery available • Adjustable nylon glides standard 	<p>WIDTH: 31.0 DEPTH: 28.0 HEIGHT: 32.5 SEAT WIDTH: 16.0 SEAT DEPTH: 18.5 SEAT HEIGHT: 17.0 BACK WIDTH: 23.5 BACK HEIGHT: 20.0 COM: 2.4 YD COL: 47.0 SQ FT WEIGHT: 30.0 LB</p>	<p>TT \$100*</p> <p>Two Tone Contrasting Upholstery (seat and back)</p>																																																		
A	B/COM	C	D	E	F	G	L3/COL	L4																																																																																											
2108	2188	2258	2333	2473	2623	2728	2408	2553																																																																																											
9221	LG	MID-BACK LOUNGE CHAIR 4 WOOD LEGS	<table border="1"> <thead> <tr> <th>A</th> <th>B/COM</th> <th>C</th> <th>D</th> <th>E</th> <th>F</th> <th>G</th> <th>L3/COL</th> <th>L4</th> </tr> </thead> <tbody> <tr> <td>2252</td> <td>2332</td> <td>2402</td> <td>2477</td> <td>2617</td> <td>2767</td> <td>2872</td> <td>2552</td> <td>2697</td> </tr> </tbody> </table>	A	B/COM	C	D	E	F	G	L3/COL	L4	2252	2332	2402	2477	2617	2767	2872	2552	2697	<ul style="list-style-type: none"> • Maple or walnut finish legs • Two-tone upholstery available • Adjustable nylon glides standard 	<p>WIDTH: 31.0 DEPTH: 28.0 HEIGHT: 32.5 SEAT WIDTH: 16.0 SEAT DEPTH: 18.5 SEAT HEIGHT: 17.0 BACK WIDTH: 23.5 BACK HEIGHT: 20.0 COM: 2.4 YD COL: 47.0 SQ FT WEIGHT: 30.0 LB</p>	<p>TT \$100*</p> <p>Two Tone Contrasting Upholstery (seat and back)</p>																																																																											
A	B/COM	C	D	E	F	G	L3/COL	L4																																																																																											
2252	2332	2402	2477	2617	2767	2872	2552	2697																																																																																											

* If the two upholstery selections are of different grades, the chair will price at the higher of the two grades.

jax

reshaping comfort

GSA SIN # 33721

- Lounge, side and guest seating
- Modern, angular design
- Warranted to 300 lbs.



SIDE

CREATING JAX MODEL NUMBER

MODEL NUMBER	CONTROL	BASE FINISH	BASE OPTIONS	CYLINDER	GRADE	CASTERS	PACKAGING	OPTIONS
9204		F	BA20			C		

PACKAGING NOTES

CODE	DESCRIPTION	LIST UPCHARGE
AB	ASSEMBLED IN BAG	\$0
BAC	BACK ASSEMBLED IN CARTON	\$0
AC	ASSEMBLED IN CARTON	\$200

MODEL	CONTROL	DESCRIPTION	FABRIC/LEATHER										FEATURES	DIMENSIONS
			A	B/COM	C	D	E	F	G	L3/COL	L4	L5		
9204	GT	SIDE CHAIR 4 METAL LEGS	1660	1735	1790	1850	1985	2085	2210	1910	2085	2410	<ul style="list-style-type: none"> • Black or silver 4-leg base • Dome glides standard 	WIDTH: 24.5 DEPTH: 24.0 HEIGHT: 31.5 SEAT WIDTH: 19.0 SEAT DEPTH: 18.0 SEAT HEIGHT: 18.0 BACK WIDTH: 20.0 BACK HEIGHT: 15.5 COM: 2.0 YD COL: 37.0 SQ FT WEIGHT: 27.0 LB
9214	GT		SIDE CHAIR WIRE ROD BASE	1710	1785	1840	1900	2035	2135	2260	1960	2135	2460	<ul style="list-style-type: none"> • Black or silver wire rod base • Optional glides available-G16 & G17
9254	R2	SIDE CHAIR 5-STAR BASE		1795	1870	1925	1985	2120	2220	2345	2045	2220	2545	<ul style="list-style-type: none"> • Polished 5-star base standard • Mechanism allows front-to-back and side-to-side rocking • 360° swivel • Pneumatic cylinder height adjustment
9224	GT		SIDE CHAIR WOOD BASE	1840	1915	1970	2030	2165	2265	2390	2090	2265	2590	<ul style="list-style-type: none"> • Maple or walnut finish • Black or Silver frame • Two-tone upholstery available • No glides available
9234	GT	SIDE CHAIR SWIVEL BASE		1835	1910	1965	2025	2160	2260	2385	2085	2260	2585	<ul style="list-style-type: none"> • Polished and black aluminum swivel base • Adjustable nylon glides standard • Optional auto-return cylinder
9264	GT		SIDE CHAIR WOOD ROCKER	1880	1955	2010	2070	2205	2305	2430	2130	2305	2630	<ul style="list-style-type: none"> • Maple or walnut finish • Black or Silver frame • Two-tone upholstery available • No glides available

BASE FINISHES

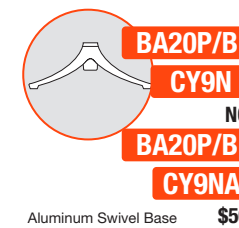

Aluminum Swivel Base
 BA20P - Polished
 BA20B - Black
 CY9N - Free Swivel
 CY9NA - Auto Return



Wire Rod
 BF - Black
 SF - Silver

BASE OPTIONS

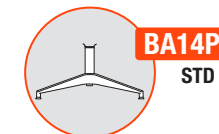

26" High Profile Aluminum Base - Polished



27" Mid-Profile Aluminum Base - Polished
 BA16B - Black
 BA16P - Polished
 (Chrome-Accented Casters Standard with Polished Base)

ADDITIONAL OPTIONS



Dome Glide (9204 only)



Swivel Steel Glide 4 per Set (9204 only)



Swivel Nylon Glide 4 per Set (9204 only)



Swivel Felt Glide 4 per Set (9204 only)



Sled Base Clear Plastic Glide (9214 only) - 4 per set



Sled Base Clear Plastic Glide with Felt (9214 only) - 4 per set



Two Tone Contrasting Upholstery (seat and back)

* If the two upholstery selections are of different grades, the chair will price at the higher of the two grades.

kelley

nothing stacks up to kelley

ALL PLASTIC - AP

GSA SIN # 33721

- High-density stacking side, guest and stool seating
- All plastic or upholstered seat
- Pull handle for easy mobility
- Warranted to 300 lbs.



CREATING KELLEY MODEL NUMBER



PACKAGING NOTES

CODE	DESCRIPTION	LIST UPCHARGE
AB	ASSEMBLED IN BAG	\$0
AC	ASSEMBLED IN CARTON	\$0

CHAIRS SHIP UP TO 5 AND STOOLS SHIP 2 PER CARTON

MODEL	CONTROL	DESCRIPTION	PLASTIC	FEATURES	DIMENSIONS
1060	GT	SLED GUEST STACKING ARMLESS Plastic back with plastic seat	P 242	<ul style="list-style-type: none"> • Stacks 9 high on the floor • Stacks 20 high on the optional stacking dolly 	WIDTH: 23.0 DEPTH: 21.0 HEIGHT: 31.0 SEAT WIDTH: 18.0 SEAT DEPTH: 16.5 SEAT HEIGHT: 18.0 BACK WIDTH: 18.0 BACK HEIGHT: 14.5 COM: N/A WEIGHT: 15.0 LB
1070	GT	SLED GUEST STACKING WITH ARMS Plastic back with plastic seat	P 297	<ul style="list-style-type: none"> • Stacks 9 high on the floor • Stacks 20 high on the optional stacking dolly • Armrests coordinate with the plastic shell color 	WIDTH: 24.0 DEPTH: 21.0 HEIGHT: 31.0 SEAT WIDTH: 18.0 SEAT DEPTH: 16.5 SEAT HEIGHT: 18.0 BACK WIDTH: 18.0 BACK HEIGHT: 14.5 COM: N/A WEIGHT: 17.0 LB

ADDITIONAL OPTIONS



GC5
\$20

Ganging Clip - 4 per set
Armless-to-Armless. 2" Between Chairs When Ganged



G16
\$15

Sled Base Clear Plastic Glide - 4 per set



G17
\$25

Sled Base Clear Plastic Glide with Felt - 4 per set

ACCESSORIES



DL7
\$399

Stacking Dolly Stacks up to 20 High

FRAME COLOR

CHROME
CF

PLASTIC COLORS

BLACK SWAN P01	WHITE WHISPER P05	FEDERAL BLUE P11	CRIMSON RED P12	LEMON YELLOW P13	DOVE GRAY P14
CLOUD GRAY P15	LAGOON BLUE P16	APPLE GREEN P17	TANGERINE ORANGE P18	LATTE P19	AZURE BLUE P20

(BACK/SEAT SHELL AND ARMS)

kelley

nothing stacks up to kelley

GSA SIN # 33721

- High-density stacking side, guest and stool seating
- All plastic or upholstered seat
- Pull handle for easy mobility
- Warranted to 300 lbs.



ALL PLASTIC - AP - STOOLS

CREATING KELLEY MODEL NUMBER

MODEL NUMBER CONTROL FRAME COLOR UPHOLSTERY PLASTIC COLOR PACKAGING OPTIONS
1 0 6 - S T - C F - A P - P - A -

PACKAGING NOTES

CODE	DESCRIPTION	LIST UPCHARGE
AB	ASSEMBLED IN BAG	\$0
AC	ASSEMBLED IN CARTON	\$0

CHAIRS SHIP UP TO 4 AND STOOLS SHIP 2 PER CARTON

MODEL	CONTROL	DESCRIPTION	PLASTIC	FEATURES	DIMENSIONS
1066	ST24	ALL PLASTIC SLED COUNTER STOOL ARMLESS Use for work surfaces up to 36" high	P 372	<ul style="list-style-type: none"> • Stacks 5 high on the floor • 24" counter stool height 	WIDTH: 23.5 DEPTH: 25.0 HEIGHT: 38.0 SEAT WIDTH: 18.0 SEAT DEPTH: 16.5 SEAT HEIGHT: 24.5 BACK WIDTH: 18.0 BACK HEIGHT: 14.5 COM: N/A WEIGHT: 18.0 LB
1066	ST30	ALL PLASTIC SLED BAR STOOL ARMLESS Use for work surfaces up to 42" high	P 392	<ul style="list-style-type: none"> • Stacks 5 high on the floor • 29" bar stool height 	WIDTH: 23.5 DEPTH: 25.0 HEIGHT: 42.5 SEAT WIDTH: 18.0 SEAT DEPTH: 16.5 SEAT HEIGHT: 29.0 BACK WIDTH: 18.0 BACK HEIGHT: 14.5 COM: N/A WEIGHT: 21.5 LB
1076	ST24	ALL PLASTIC SLED COUNTER STOOL WITH ARMS Use for work surfaces up to 36" high	P 427	<ul style="list-style-type: none"> • Stacks 5 high on the floor • 24" counter stool height • Armrests coordinate with the plastic shell color 	WIDTH: 24.0 DEPTH: 25.0 HEIGHT: 38.0 SEAT WIDTH: 18.0 SEAT DEPTH: 16.5 SEAT HEIGHT: 24.5 BACK WIDTH: 18.0 BACK HEIGHT: 14.5 COM: N/A WEIGHT: 20.0 LB
1076	ST30	ALL PLASTIC SLED BAR STOOL WITH ARMS Use for work surfaces up to 42" high	P 447	<ul style="list-style-type: none"> • Stacks 5 high on the floor • 29" bar stool height • Armrests coordinate with the plastic shell color 	WIDTH: 24.0 DEPTH: 25.0 HEIGHT: 42.5 SEAT WIDTH: 18.0 SEAT DEPTH: 16.5 SEAT HEIGHT: 29.0 BACK WIDTH: 18.0 BACK HEIGHT: 14.5 COM: N/A WEIGHT: 23.0 LB

ADDITIONAL OPTIONS

 GC5 \$20 Ganging Clip - 4 per set Armless-to-Armless, 2" Between Chairs When Ganged	 G16 \$15 Sled Base Clear Plastic Glide - 4 per set	 G17 \$25 Sled Base Clear Plastic Glide with Felt - 4 per set
---	---	---

FRAME COLOR

CHROME
CF

PLASTIC COLORS

BLACK SWAN P01	WHITE WHISPER P05	FEDERAL BLUE P11	CRIMSON RED P12	LEMON YELLOW P13	DOVE GRAY P14
CLOUD GRAY P15	LAGOON BLUE P16	APPLE GREEN P17	TANGERINE ORANGE P18	LATTE P19	AZURE BLUE P20

(BACK/SEAT SHELL AND ARMS)

kelley

nothing stacks up to kelley

GSA SIN # 33721

- High-density stacking side, guest and stool seating
- All plastic or upholstered seat
- Pull handle for easy mobility
- Warranted to 300 lbs.



UPHOLSTERED SEAT - US

CREATING KELLEY MODEL NUMBER

MODEL NUMBER CONTROL FRAME COLOR UPHOLSTERY PLASTIC COLOR GRADE PACKAGING OPTIONS
1000-GT-CF-US-P

PACKAGING NOTES

CODE	DESCRIPTION	LIST UPCHARGE
AB	ASSEMBLED IN BAG	\$0
AC	ASSEMBLED IN CARTON	\$0

CHAIRS SHIP UP TO 5 AND STOOLS SHIP 2 PER CARTON

MODEL	CONTROL	DESCRIPTION	FABRIC	FEATURES	DIMENSIONS														
1060	GT	SLED GUEST STACKING ARMLESS Plastic back with upholstered seat	<table border="1"> <thead> <tr> <th>A</th> <th>B/COM</th> <th>C</th> <th>D</th> <th>E</th> <th>F</th> <th>G</th> </tr> </thead> <tbody> <tr> <td>302</td> <td>332</td> <td>352</td> <td>392</td> <td>432</td> <td>472</td> <td>512</td> </tr> </tbody> </table>	A	B/COM	C	D	E	F	G	302	332	352	392	432	472	512	<ul style="list-style-type: none"> • Stacks 7 high on the floor • Stacks 20 high on the optional stacking dolly 	WIDTH: 23.0 DEPTH: 21.0 HEIGHT: 31.0 SEAT WIDTH: 18.0 SEAT DEPTH: 16.5 SEAT HEIGHT: 19.0 BACK WIDTH: 18.0 BACK HEIGHT: 14.5 COM: 0.8 YD WEIGHT: 15.0 LB
A	B/COM	C	D	E	F	G													
302	332	352	392	432	472	512													

MODEL	CONTROL	DESCRIPTION	FABRIC	FEATURES	DIMENSIONS														
1070	GT	SLED GUEST STACKING WITH ARMS Plastic back with upholstered seat	<table border="1"> <thead> <tr> <th>A</th> <th>B/COM</th> <th>C</th> <th>D</th> <th>E</th> <th>F</th> <th>G</th> </tr> </thead> <tbody> <tr> <td>357</td> <td>387</td> <td>407</td> <td>447</td> <td>487</td> <td>527</td> <td>567</td> </tr> </tbody> </table>	A	B/COM	C	D	E	F	G	357	387	407	447	487	527	567	<ul style="list-style-type: none"> • Stacks 7 high on the floor • Stacks 20 high on the optional stacking dolly • Armrests coordinate with the plastic shell color 	WIDTH: 24.0 DEPTH: 21.0 HEIGHT: 31.0 SEAT WIDTH: 18.0 SEAT DEPTH: 16.5 SEAT HEIGHT: 19.0 BACK WIDTH: 18.0 BACK HEIGHT: 14.5 COM: 0.8 YD WEIGHT: 17.0 LB
A	B/COM	C	D	E	F	G													
357	387	407	447	487	527	567													

ADDITIONAL OPTIONS



GC5
\$20

Ganging Clip - 4 per set
Armless-to-Armless. 2" Between Chairs When Ganged



G16
\$15

Sled Base Clear Plastic Glide - 4 per set



G17
\$25

Sled Base Clear Plastic Glide with Felt - 4 per set

ACCESSORIES



DL7
\$399

Stacking Dolly Stacks up to 16 High

Due to the nature of upholstery, stacking may cause impressions on the seat. 9to5 Seating does not warrant effects of stacking on upholstery.

FRAME COLOR

CHROME
CF

PLASTIC COLORS

BLACK SWAN P01	WHITE WHISPER P05	FEDERAL BLUE P11	CRIMSON RED P12	LEMON YELLOW P13	DOVE GRAY P14
CLOUD GRAY P15	LAGOON BLUE P16	APPLE GREEN P17	TANGERINE ORANGE P18	LATTE P19	AZURE BLUE P20

(BACK/SEAT SHELL AND ARMS)

kelley

nothing stacks up to kelley

GSA SIN # 33721

- High-density stacking side, guest and stool seating
- All plastic or upholstered seat
- Pull handle for easy mobility
- Warranted to 300 lbs.



UPHOLSTERED SEAT - US - STOOLS

CREATING KELLEY MODEL NUMBER

MODEL NUMBER CONTROL FRAME COLOR UPHOLSTERY PLASTIC COLOR GRADE PACKAGING OPTIONS

1 0 6 - S T - C F - U S - P - A

PACKAGING NOTES

CODE	DESCRIPTION	LIST UPCHARGE
AB	ASSEMBLED IN BAG	\$0
AC	ASSEMBLED IN CARTON	\$0

CHAIRS SHIP UP TO 4 AND STOOLS SHIP 2 PER CARTON

MODEL	CONTROL	DESCRIPTION	FABRIC	FEATURES	DIMENSIONS														
1066	ST24	UPHOLSTERED SEAT SLED COUNTER STOOL ARMLESS Use for work surfaces up to 36" high	<table border="1"> <thead> <tr> <th>A</th> <th>B/COM</th> <th>C</th> <th>D</th> <th>E</th> <th>F</th> <th>G</th> </tr> </thead> <tbody> <tr> <td>432</td> <td>462</td> <td>482</td> <td>522</td> <td>562</td> <td>602</td> <td>642</td> </tr> </tbody> </table>	A	B/COM	C	D	E	F	G	432	462	482	522	562	602	642	<ul style="list-style-type: none"> • Stacks 5 high on the floor • 24" counter stool height 	WIDTH: 23.5 DEPTH: 25.0 HEIGHT: 38.0 SEAT WIDTH: 18.0 SEAT DEPTH: 16.5 SEAT HEIGHT: 25.5 BACK WIDTH: 18.0 BACK HEIGHT: 14.5 COM: 0.8 YD WEIGHT: 18.0 LB
A	B/COM	C	D	E	F	G													
432	462	482	522	562	602	642													
1066	ST30	UPHOLSTERED SEAT SLED BAR STOOL ARMLESS Use for work surfaces up to 42" high	<table border="1"> <thead> <tr> <th>A</th> <th>B/COM</th> <th>C</th> <th>D</th> <th>E</th> <th>F</th> <th>G</th> </tr> </thead> <tbody> <tr> <td>452</td> <td>482</td> <td>502</td> <td>542</td> <td>582</td> <td>622</td> <td>662</td> </tr> </tbody> </table>	A	B/COM	C	D	E	F	G	452	482	502	542	582	622	662	<ul style="list-style-type: none"> • Stacks 5 high on the floor • 29" bar stool height 	WIDTH: 24.0 DEPTH: 25.0 HEIGHT: 42.5 SEAT WIDTH: 18.0 SEAT DEPTH: 16.5 SEAT HEIGHT: 30.0 BACK WIDTH: 18.0 BACK HEIGHT: 14.5 COM: 0.8 YD WEIGHT: 21.5 LB
A	B/COM	C	D	E	F	G													
452	482	502	542	582	622	662													
1076	ST24	UPHOLSTERED SEAT SLED COUNTER STOOL WITH ARMS Use for work surfaces up to 36" high	<table border="1"> <thead> <tr> <th>A</th> <th>B/COM</th> <th>C</th> <th>D</th> <th>E</th> <th>F</th> <th>G</th> </tr> </thead> <tbody> <tr> <td>487</td> <td>517</td> <td>537</td> <td>577</td> <td>617</td> <td>657</td> <td>697</td> </tr> </tbody> </table>	A	B/COM	C	D	E	F	G	487	517	537	577	617	657	697	<ul style="list-style-type: none"> • Stacks 5 high on the floor • 24" counter stool height • Armrests coordinate with the plastic shell color 	WIDTH: 24.0 DEPTH: 25.0 HEIGHT: 38.0 SEAT WIDTH: 18.0 SEAT DEPTH: 16.5 SEAT HEIGHT: 25.5 BACK WIDTH: 18.0 BACK HEIGHT: 14.5 COM: 0.8 YD WEIGHT: 20.0 LB
A	B/COM	C	D	E	F	G													
487	517	537	577	617	657	697													
1076	ST30	UPHOLSTERED SEAT SLED BAR STOOL WITH ARMS Use for work surfaces up to 42" high	<table border="1"> <thead> <tr> <th>A</th> <th>B/COM</th> <th>C</th> <th>D</th> <th>E</th> <th>F</th> <th>G</th> </tr> </thead> <tbody> <tr> <td>507</td> <td>537</td> <td>557</td> <td>597</td> <td>637</td> <td>677</td> <td>717</td> </tr> </tbody> </table>	A	B/COM	C	D	E	F	G	507	537	557	597	637	677	717	<ul style="list-style-type: none"> • Stacks 5 high on the floor • 29" bar stool height • Armrests coordinate with the plastic shell color 	WIDTH: 24.0 DEPTH: 25.0 HEIGHT: 42.5 SEAT WIDTH: 18.0 SEAT DEPTH: 16.5 SEAT HEIGHT: 30.0 BACK WIDTH: 18.0 BACK HEIGHT: 14.5 COM: 0.8 YD WEIGHT: 23.0 LB
A	B/COM	C	D	E	F	G													
507	537	557	597	637	677	717													

ADDITIONAL OPTIONS

 GC5 \$20	 G16 \$15	 G17 \$25
Ganging Clip - 4 per set Armless-to-Armless, 2" Between Chairs When Ganged	Sled Base Clear Plastic Glide - 4 per set	Sled Base Clear Plastic Glide with Felt - 4 per set

FRAME COLOR

CHROME
CF

PLASTIC COLORS

BLACK SWAN P01	WHITE WHISPER P05	FEDERAL BLUE P11	CRIMSON RED P12	LEMON YELLOW P13	DOVE GRAY P14
CLOUD GRAY P15	LAGOON BLUE P16	APPLE GREEN P17	TANGERINE ORANGE P18	LATTE P19	AZURE BLUE P20

(BACK/SEAT SHELL AND ARMS)

kip
modern stacking

GSA SIN # 33721

- High-density stacking side, guest and stool seating
- Lightweight construction for ultimate portability
- Mesh back and mesh seat
- Warranted to 300 lbs.



ALL MESH

CREATING KIP MODEL NUMBER

MODEL NUMBER CONTROL FRAME COLOR PLASTIC COLOR PACKAGING OPTIONS
1080 - GT - CF - P - A -

PACKAGING NOTES

CODE	DESCRIPTION	LIST UPCHARGE
AB	ASSEMBLED IN BAG	\$0
AC	ASSEMBLED IN CARTON	\$0

CHAIRS SHIP UP TO 5 AND STOOLS SHIP 2 PER CARTON

MODEL	CONTROL	DESCRIPTION	ARM	MESH	FEATURES	DIMENSIONS
1080	GT	SLED GUEST STACKING ARMLESS Mesh back with mesh seat		M 390	<ul style="list-style-type: none"> • Stacks 9 high on the floor • Stacks 14 high on the optional stacking dolly 	WIDTH: 21.0 DEPTH: 21.5 HEIGHT: 33.0 SEAT WIDTH: 18.5 SEAT DEPTH: 16.5 SEAT HEIGHT: 18.5 BACK WIDTH: 18.0 BACK HEIGHT: 15.5 WEIGHT: 14.0 LB
1081	GT	SLED GUEST STACKING ARMED Mesh back with mesh seat		M 445	<ul style="list-style-type: none"> • Stacks 9 high on the floor • Stacks 14 high on the optional stacking dolly • Armrests coordinate with the plastic shell 	WIDTH: 24.0 DEPTH: 21.5 HEIGHT: 33.0 SEAT WIDTH: 18.5 SEAT DEPTH: 16.5 SEAT HEIGHT: 18.5 BACK WIDTH: 18.0 BACK HEIGHT: 15.5 WEIGHT: 16.0 LB

ADDITIONAL OPTIONS

 <p>GC5 \$20</p> <p>Ganging Clip - 4 per set Armless-to-Armless. 2" Between Chairs When Ganged</p>	 <p>G16 \$15</p> <p>Sled Base Clear Plastic Glide - 4 per set</p>	 <p>G17 \$25</p> <p>Sled Base Clear Plastic Glide with Felt - 4 per set</p>
--	---	---

ACCESSORIES



DL7
\$399

Stacking Dolly Stacks
up to 14 High

FRAME COLOR

CHROME
CF

PLASTIC COLORS

BLACK SWAN P01	DOVE GRAY P14
----------------------	---------------------

(BACK/SEAT FRAME AND ARMS)

kip

modern stacking

GSA SIN # 33721

- High-density stacking side, guest and stool seating
- Lightweight construction for ultimate portability
- Mesh back and mesh seat
- Warranted to 300 lbs.



CREATING KIP MODEL NUMBER

MODEL NUMBER CONTROL FRAME COLOR PLASTIC COLOR PACKAGING OPTIONS
1080-ST-CF-P-A

PACKAGING NOTES

CODE	DESCRIPTION	LIST UPCHARGE
AB	ASSEMBLED IN BAG	\$0
AC	ASSEMBLED IN CARTON	\$0

CHAIRS SHIP UP TO 5 AND STOOLS SHIP 2 PER CARTON

ALL MESH

MODEL	CONTROL	DESCRIPTION	ARM	MESH	FEATURES	DIMENSIONS
1080	ST24	ALL MESH SLED COUNTER STOOL ARMLESS Use for work surfaces up to 36" high		M 520	<ul style="list-style-type: none"> • Stacks 5 high on the floor • 24" counter stool height 	WIDTH: 21.0 DEPTH: 25.5 HEIGHT: 44.0 SEAT WIDTH: 18.5 SEAT DEPTH: 16.5 SEAT HEIGHT: 29.5 BACK WIDTH: 18.0 BACK HEIGHT: 15.5 WEIGHT: 17.0 LB
1080	ST30	ALL MESH SLED BAR STOOL ARMLESS Use for work surfaces up to 42" high		M 540	<ul style="list-style-type: none"> • Stacks 5 high on the floor • 29" bar stool height • Armrests coordinate with the plastic shell color 	WIDTH: 21.0 DEPTH: 25.5 HEIGHT: 44.0 SEAT WIDTH: 18.5 SEAT DEPTH: 16.5 SEAT HEIGHT: 29.5 BACK WIDTH: 18.0 BACK HEIGHT: 15.5 WEIGHT: 20.5 LB
1081	ST24	ALL MESH SLED COUNTER STOOL ARMED Use for work surfaces up to 36" high		M 575	<ul style="list-style-type: none"> • Stacks 5 high on the floor • 24" counter stool height • Armrests coordinate with the plastic shell color 	WIDTH: 24.0 DEPTH: 25.5 HEIGHT: 44.0 SEAT WIDTH: 18.5 SEAT DEPTH: 16.5 SEAT HEIGHT: 25.5 BACK WIDTH: 18.0 BACK HEIGHT: 15.5 WEIGHT: 19.0 LB
1081	ST30	ALL MESH SLED BAR STOOL ARMED Use for work surfaces up to 42" high		M 595	<ul style="list-style-type: none"> • Stacks 5 high on the floor • 29" bar stool height • Armrests coordinate with the plastic shell color 	WIDTH: 24.0 DEPTH: 25.5 HEIGHT: 44.0 SEAT WIDTH: 18.5 SEAT DEPTH: 16.5 SEAT HEIGHT: 29.5 BACK WIDTH: 18.0 BACK HEIGHT: 15.5 WEIGHT: 22.0 LB

ADDITIONAL OPTIONS

 GC5 \$20	 G16 \$15	 G17 \$25
Ganging Clip - 4 per set Armless-to-Armless. 2" Between Chairs When Ganged	Sled Base Clear Plastic Glide - 4 per set	Sled Base Clear Plastic Glide with Felt - 4 per set

FRAME COLOR

CHROME
CF

PLASTIC COLORS

BLACK SWAN P01 DOVE GRAY P14

(BACK/SEAT FRAME AND ARMS)

koble

modular soft seating

GSA SIN # 33721 PENDING

- Choose from a wide variety of seats, benches, tables and ottomans
- Build using straight, 90° or 120° models
- Promote an active working posture with integrated lumbar support and comfort-calibrated seat
- Blend with any environment using black and medium base colors
- Two tone upholstery available
- Power options available
- Adjustable glides standard
- 400 lb. weight rating (per seat)



CREATING KOBLE MODEL NUMBER

MODEL NUMBER ARM BASE UPHOLSTERY OPTIONS POWER PACKAGING

9 3 - A - - - - - A

PACKAGING NOTES

CODE	DESCRIPTION	LIST UPCHARGE
AB	ASSEMBLED IN BAG	\$0
AC	ASSEMBLED IN CARTON	\$0

NEW

MODEL	CONTROL	DESCRIPTION	FABRIC/LEATHER							FEATURES	DIMENSIONS
			A	B/COM	C	D	E	F	G		
9300		SINGLE BENCH	1280	1328	1355	1389	1437	1485	1533	<ul style="list-style-type: none"> • Shadow base in black or medium gray • Adjustable glides standard • Power options available 	OVERALL WIDTH: 26.0 OVERALL DEPTH: 28.0 OVERALL HEIGHT: 18.0 SEAT WIDTH: 26.0 SEAT DEPTH: 28.0 SEAT HEIGHT: 18.0 COM: 1.5 YD
9301		SINGLE SEAT	1625	1714	1747	1790	1862	1945	2017	<ul style="list-style-type: none"> • Arms available • Shadow base in black or medium gray • Integrated lumbar support • Adjustable glides standard • Two-tone upholstery available • Power options available 	OVERALL WIDTH: 26.0 OVERALL DEPTH: 28.0 OVERALL HEIGHT: 32.5 SEAT WIDTH: 26.0 SEAT DEPTH: 18.5 SEAT HEIGHT: 18.0 BACK WIDTH: 26.0 BACK HEIGHT: 14.0 WEIGHT: TBD
9301-A62L/R		SINGLE SEAT W/ ONE ARM	1830	1964	2022	2095	2192	2345	2457	<ul style="list-style-type: none"> • Arms available • Shadow base in black or medium gray • Integrated lumbar support • Adjustable glides standard • Two-tone upholstery available • Arm Upholstery matches back • Power options available 	OVERALL WIDTH: 29.0 OVERALL DEPTH: 28.0 OVERALL HEIGHT: 32.5 SEAT WIDTH: 26.0 SEAT DEPTH: 18.5 SEAT HEIGHT: 18.0 BACK WIDTH: 26.0 BACK HEIGHT: 14.0 COM: 2.5 YD WEIGHT: TBD
9301-A62B		SINGLE SEAT W/ BOTH ARMS	2035	2214	2297	2400	2522	2745	2897	<ul style="list-style-type: none"> • Arms available • Shadow base in black or medium gray • Integrated lumbar support • Adjustable glides standard • Two-tone upholstery available • Arm Upholstery matches back • Power options available 	OVERALL WIDTH: 32.0 OVERALL DEPTH: 28.0 OVERALL HEIGHT: 32.5 SEAT WIDTH: 26.0 SEAT DEPTH: 18.5 SEAT HEIGHT: 18.0 BACK WIDTH: 26.0 BACK HEIGHT: 14.0 COM: 2.5 YD WEIGHT: TBD
9303		TABLE	1610	1655	1681	1713	1758	1803	1848	<ul style="list-style-type: none"> • Multiple Laminate colors available • Shadow base in black or medium gray • Adjustable glides standard • Power options available 	OVERALL WIDTH: 26.0 OVERALL DEPTH: 28.0 OVERALL HEIGHT: 18.0 SEAT WIDTH: 26.0 SEAT DEPTH: 28.0 SEAT HEIGHT: 18.0 BACK WIDTH: 0.0 BACK HEIGHT: 0.0 COM: 1.5 YD WEIGHT: TBD
9310		120° BENCH	PRICING AVAILABLE SOON							<ul style="list-style-type: none"> • Shadow base in black or medium gray • Adjustable glides standard 	OVERALL WIDTH: 31.0 OVERALL DEPTH: 32.0 OVERALL HEIGHT: 18.0 SEAT WIDTH: 33.5 SEAT DEPTH: 28.0 SEAT HEIGHT: 18.0 BACK WIDTH: 0.0 BACK HEIGHT: 0.0 WEIGHT: TBD

BASE OPTIONS

BLACK BP	MEDIUM GRAY MGP
----------	-----------------

LAMINATE OPTIONS

BEIGEWOOD BG	DESIGNER WHITE DW	JUBILEE OAK OAK	FLORENCE WALNUT WAL
--------------	-------------------	-----------------	---------------------

ADDITIONAL OPTIONS

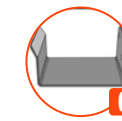

GC11

\$45



G25B

STD

Adjustable Glides



TT

\$100

Two-Tone upholstery
*If the two upholstery selections are of different grades, the chair will price at the higher of the two grades. Back and arms are one upholstery.

POWER OPTIONS AND LOCATIONS

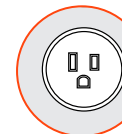

P

\$125

AC/110V



U

\$230

USB

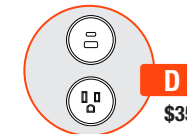

D

\$355

AC/110V & USB

Power and USB gray in color. Power available on bench (9300), single seat (9301), and table (9303).

LEGEND

- PFL – Power Front Left
- PFR – Power Front Right
- PSL – Power Side Left
- PSR – Power Side Right
- PBL – Power Back Left
- PBR – Power Back Right
- UFL – USB Front Left
- UFR – USB Front Right
- USL – USB Side Left
- USR – USB Side Right
- UBL – USB Back Left
- UBR – USB Back Right
- DFL – Dual Front Left
- DFR – Dual Front Right
- DSL – Dual Side Left
- DSR – Dual Side Right
- DBL – Dual Back Left
- DBR – Dual Back Right

9300 & 9303 FRONT AND BACK LOCATIONS

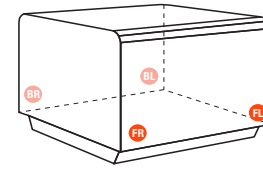

9300 & 9303 SIDE LOCATIONS

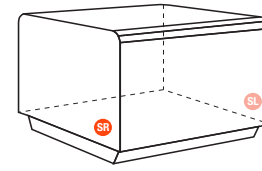

9301 FRONT AND SIDE LOCATIONS

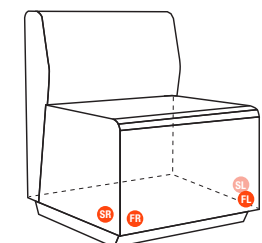

koble

modular soft seating

GSA SIN # 33721 PENDING

- Choose from a wide variety of seats, benches, tables and ottomans
- Build using straight, 90° or 120° models
- Promote an active working posture with integrated lumbar support and comfort-calibrated seat
- Blend with any environment using black and medium base colors
- Two tone upholstery available
- Power options available
- Adjustable glides standard
- 400 lb. weight rating (per seat)



CREATING KOBLE MODEL NUMBER

MODEL NUMBER ARM BASE UPHOLSTERY OPTIONS POWER PACKAGING

9 3 [] [] - A [] [] [] - [] [] [] - [] [] [] - [] [] [] - [] [] [] - A [] []

PACKAGING NOTES

CODE	DESCRIPTION	LIST UPCHARGE
AB	ASSEMBLED IN BAG	\$0
AC	ASSEMBLED IN CARTON	\$0

NEW

MODEL	CONTROL	DESCRIPTION	FABRIC/LEATHER	FEATURES	DIMENSIONS																												
9311		120° OUTER SEAT	PRICING AVAILABLE SOON	<ul style="list-style-type: none"> • Shadow base in black or medium gray • Integrated lumbar support • Adjustable glides standard • Two-tone upholstery available 	OVERALL WIDTH: 31.0 OVERALL DEPTH: 32.0 OVERALL HEIGHT: 32.5 SEAT WIDTH: 33.5 SEAT DEPTH: 18.5 SEAT HEIGHT: 18.0 BACK WIDTH: 13.5 BACK HEIGHT: 14.0 WEIGHT: TBD																												
9312		120° INNER SEAT	PRICING AVAILABLE SOON	<ul style="list-style-type: none"> • Shadow base in black or medium gray • Integrated lumbar support • Adjustable glides standard • Two-tone upholstery available 	OVERALL WIDTH: 31.0 OVERALL DEPTH: 32.5 OVERALL HEIGHT: 32.5 SEAT WIDTH: 9.5 SEAT DEPTH: 18.5 SEAT HEIGHT: 18.0 BACK WIDTH: 29.5 BACK HEIGHT: 14.0 WEIGHT: TBD																												
9320		90° CORNER BENCH	PRICING AVAILABLE SOON	<ul style="list-style-type: none"> • Shadow base in black or medium gray • Adjustable glides standard 	OVERALL WIDTH: 35.5 OVERALL DEPTH: 35.5 OVERALL HEIGHT: 18.0 SEAT WIDTH: 47.5 SEAT DEPTH: 28.0 SEAT HEIGHT: 18.0 BACK WIDTH: 0.0 BACK HEIGHT: 0.0 WEIGHT: TBD																												
9321		90° OUTER SEAT	PRICING AVAILABLE SOON	<ul style="list-style-type: none"> • Shadow base in black or medium gray • Integrated lumbar support • Adjustable glides standard • Two-tone upholstery available 	OVERALL WIDTH: 35.5 OVERALL DEPTH: 35.5 OVERALL HEIGHT: 32.5 SEAT WIDTH: 47.5 SEAT DEPTH: 18.5 SEAT HEIGHT: 18.0 BACK WIDTH: 19.5 BACK HEIGHT: 14.0 WEIGHT: TBD																												
9322		90° INNER SEAT	<table border="1"> <thead> <tr> <th>A</th> <th>B/COM</th> <th>C</th> <th>D</th> <th>E</th> <th>F</th> <th>G</th> </tr> </thead> <tbody> <tr> <td>3095</td> <td>3235</td> <td>3288</td> <td>3351</td> <td>3456</td> <td>3565</td> <td>3670</td> </tr> <tr> <td> </td> <td> </td> <td> </td> <td> </td> <td> </td> <td> </td> <td> </td> </tr> <tr> <td> </td> <td> </td> <td> </td> <td> </td> <td> </td> <td> </td> <td> </td> </tr> </tbody> </table>	A	B/COM	C	D	E	F	G	3095	3235	3288	3351	3456	3565	3670															<ul style="list-style-type: none"> • Shadow base in black or medium gray • Integrated lumbar support • Adjustable glides standard • Two-tone upholstery available 	OVERALL WIDTH: 35.5 OVERALL DEPTH: 35.5 OVERALL HEIGHT: 32.5 SEAT WIDTH: 27.0 SEAT DEPTH: 18.5 SEAT HEIGHT: 18.0 BACK WIDTH: 46.0 BACK HEIGHT: 14.0 COM: 5.0 YD WEIGHT: TBD
A	B/COM	C	D	E	F	G																											
3095	3235	3288	3351	3456	3565	3670																											
9323		90° CORNER SEAT	<table border="1"> <thead> <tr> <th>A</th> <th>B/COM</th> <th>C</th> <th>D</th> <th>E</th> <th>F</th> <th>G</th> </tr> </thead> <tbody> <tr> <td>2495</td> <td>2630</td> <td>2690</td> <td>2745</td> <td>2850</td> <td>2959</td> <td>3066</td> </tr> <tr> <td> </td> <td> </td> <td> </td> <td> </td> <td> </td> <td> </td> <td> </td> </tr> <tr> <td> </td> <td> </td> <td> </td> <td> </td> <td> </td> <td> </td> <td> </td> </tr> </tbody> </table>	A	B/COM	C	D	E	F	G	2495	2630	2690	2745	2850	2959	3066															<ul style="list-style-type: none"> • Shadow base in black or medium gray • Adjustable glides standard • Two-tone upholstery available • Integrated lumbar support 	OVERALL WIDTH: 28.0 OVERALL DEPTH: 28.0 OVERALL HEIGHT: 32.5 SEAT WIDTH: 29.5 SEAT DEPTH: 28.0 SEAT HEIGHT: 18.0 BACK WIDTH: 35.5 BACK HEIGHT: 14.0 COM: 4.0 YD WEIGHT: TBD
A	B/COM	C	D	E	F	G																											
2495	2630	2690	2745	2850	2959	3066																											

BASE OPTIONS

BLACK BP	MEDIUM GRAY MGP
----------	-----------------

LAMINATE OPTIONS

BEIGEWOOD BG	DESIGNER WHITE DW	JUBILEE OAK OAK	FLORENCE WALNUT WAL
--------------	-------------------	-----------------	---------------------

ADDITIONAL OPTIONS

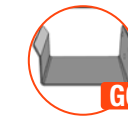

GC11
\$45

Ganging Clip
Set of 2



G25B
STD

Adjustable Glides



TT
\$100

Two-Tone upholstery
*If the two upholstery selections are of different grades, the chair will price at the higher of the two grades. Back and arms are one upholstery.

POWER OPTIONS AND LOCATIONS

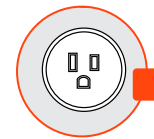

P
\$125

AC/110V

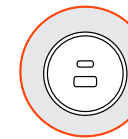

U
\$230

USB

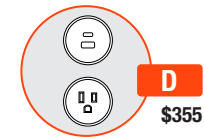

D
\$355

AC/110V & USB

Power and USB gray in color. Power available on bench (9300), single seat (9301), and table (9303).

LEGEND

- | | | |
|-------------------------|-----------------------|------------------------|
| PFL – Power Front Left | UFL – USB Front Left | DFL – Dual Front Left |
| PFR – Power Front Right | UFR – USB Front Right | DFR – Dual Front Right |
| PSL – Power Side Left | USL – USB Side Left | DSL – Dual Side Left |
| PSR – Power Side Right | USR – USB Side Right | DSR – Dual Side Right |
| PBL – Power Back Left | UBL – USB Back Left | DBL – Dual Back Left |
| PBR – Power Back Right | UBR – USB Back Right | DBR – Dual Back Right |

9300 & 9303 FRONT AND BACK LOCATIONS

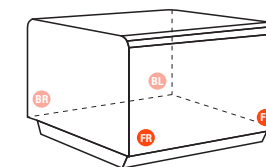

9300 & 9303 SIDE LOCATIONS

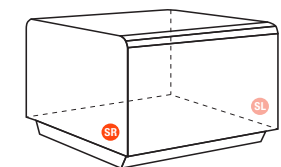

9301 FRONT AND SIDE LOCATIONS

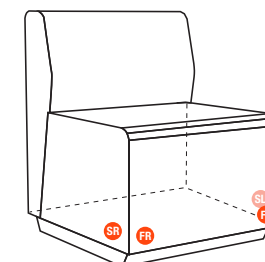

koble

modular soft seating

GSA SIN # 33721 PENDING

- Choose from a wide variety of seats, benches, tables and ottomans
- Build using straight, 90- or 120-degree models
- Promote an active working posture with integrated lumbar support and comfort-calibrated seat
- Blend with any environment using black and medium base colors
- Two tone upholstery available
- Power options available
- Adjustable glides standard
- 400 lb. weight rating (per seat)



CREATING KOBLE MODEL NUMBER

MODEL NUMBER ARM BASE UPHOLSTERY OPTIONS POWER PACKAGING

9 3 [] [] - A [] [] [] - [] [] [] - [] [] [] - [] [] [] - [] [] [] - A [] []

PACKAGING NOTES

CODE	DESCRIPTION	LIST UPCHARGE
AB	ASSEMBLED IN BAG	\$0
AC	ASSEMBLED IN CARTON	\$0

TYPICAL 1

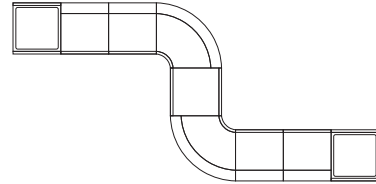

LINE	MODEL	QTY	DESCRIPTION	LIST PRICE/ GRADE A	EXT PRICE
1	9300	1	SINGLE BENCH	1280	\$1,280
2	9301	4	SINGLE SEAT	1625	\$6,500
3	9303	2	TABLE	1610	\$3,220
4	9322	2	90° INNER SEAT	3095	\$6,190
5	G25B	8	GANGING CLIP	45	\$360

TOTAL: \$17,550

TYPICAL 7

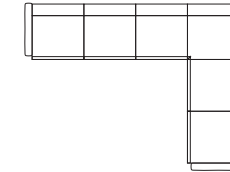

LINE	MODEL	QTY	DESCRIPTION	LIST PRICE/ GRADE A	EXT PRICE
1	9301	1	SINGLE SEAT W/ LEFT ARM	1830	\$1,830
2	9301	1	SINGLE SEAT W/ RIGHT ARM	1830	\$1,830
3	9301	3	SINGLE SEATS	1625	\$4,875
4	9323	1	90° CORNER SEAT	2495	\$2,495
5	G25B	5	GANGING CLIP	45	\$225

TOTAL: \$11,255

TYPICAL 2

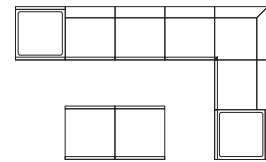

LINE	MODEL	QTY	DESCRIPTION	LIST PRICE/ GRADE A	EXT PRICE
1	9303	2	TABLES	1610	\$3,220
2	9301	4	SINGLE SEAT	1625	\$6,500
3	9300	2	SINGLE BENCH	1280	\$2,560
4	9323	1	90° CORNER SEAT	2495	\$2,495
5	G25B	7	GANGING CLIP	45	\$315

TOTAL: \$15,090

TYPICAL 8

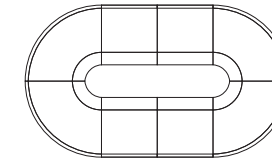

LINE	MODEL	QTY	DESCRIPTION	LIST PRICE/ GRADE A	EXT PRICE
1	9321	4	90° OUTSIDE SWEEP	TBD	TBD
2	9301	4	SINGLE SEAT	1625	\$6,500
3	G25B	8	GANGING CLIP	45	TBD

TOTAL: TBD

TYPICAL 3

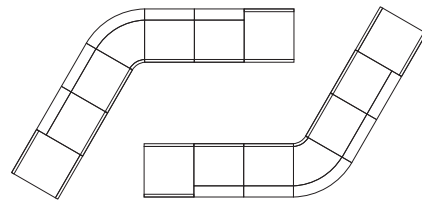

LINE	MODEL	QTY	DESCRIPTION	LIST PRICE/ GRADE A	EXT PRICE
1	9300	4	SINGLE BENCH	1280	\$5,120
2	9301	8	SINGLE SEAT	1625	\$13,000
3	9312	2	120° INNER SEAT	TBD	TBD
4	G25B	12	GANGING CLIP	45	\$540

TOTAL: TBD

TYPICAL 4

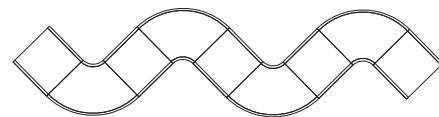

LINE	MODEL	QTY	DESCRIPTION	LIST PRICE/ GRADE A	EXT PRICE
1	9320	4	90° CORNER BENCH	TBD	TBD
2	9300	5	SINGLE BENCH	1280	\$6,400
3	G25B	8	GANGING CLIP	45	\$360

TOTAL: TBD

TYPICAL 5

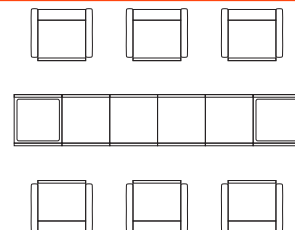

LINE	MODEL	QTY	DESCRIPTION	LIST PRICE/ GRADE A	EXT PRICE
1	9301	6	SINGLE SEATS W/ ARMS	2035	\$12,210
2	9300	4	SINGLE BENCH	1280	\$5,120
3	9303	2	TABLE	1610	\$3,220
4	G25B	5	GANGING CLIP	45	\$225

TOTAL: \$20,775

TYPICAL 6

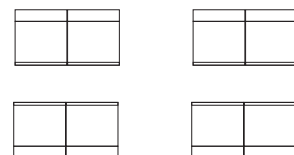

LINE	MODEL	QTY	DESCRIPTION	LIST PRICE/ GRADE A	EXT PRICE
1	9301	8	SINGLE SEAT	1625	\$13,000
2	G25B	4	GANGING CLIP	45	\$180

TOTAL: \$13,180

NEW

lilly

classic, sophisticated and supremely comfortable

GSA SIN # 33721

- Lounge, side and stool seating
- Classic, sophisticated design
- Warranted to 300 lbs.



MID-BACK LOUNGE

CREATING LILLY MODEL NUMBER

MODEL NUMBER	CONTROL	BASE FINISH	CYLINDER	GRADE	PACKAGING	OPTIONS
91	1	LG				

PACKAGING NOTES

CODE	DESCRIPTION	LIST UPCHARGE
AB	ASSEMBLED IN BAG	\$0
BAC	BACK ASSEMBLED IN CARTON	\$0
AC	ASSEMBLED IN CARTON	\$200

LILLY 9121 SHIPS AB AT \$0 (ASSEMBLED IN BAG) OR AC AT \$0 (ASSEMBLED IN CARTON) ONLY

MODEL	CONTROL	DESCRIPTION	FABRIC/LEATHER	FEATURES	DIMENSIONS																				
9101	LG	LOUNGE CHAIR 4 METAL LEGS	<table border="1"> <thead> <tr> <th>A</th><th>B/COM</th><th>C</th><th>D</th><th>E</th><th>F</th><th>G</th><th>L3/COL</th><th>L4</th><th>L5</th> </tr> </thead> <tbody> <tr> <td>1789</td><td>1869</td><td>1939</td><td>2014</td><td>2159</td><td>2309</td><td>2429</td><td>2089</td><td>2234</td><td>2739</td> </tr> </tbody> </table>	A	B/COM	C	D	E	F	G	L3/COL	L4	L5	1789	1869	1939	2014	2159	2309	2429	2089	2234	2739	<ul style="list-style-type: none"> • Black or silver 4-leg base • Dome glides standard • Two-tone upholstery available • Adjustable nylon glides standard 	<p>WIDTH: 27.0 DEPTH: 29.0 HEIGHT: 33.0 SEAT WIDTH: 23.5 SEAT DEPTH: 19.0 SEAT HEIGHT: 16.0 BACK WIDTH: 23.5 BACK HEIGHT: 22.0 COM: 2.9 YD COL: 54.0 SQ FT WEIGHT: 32.0 LB</p>
A	B/COM		C	D	E	F	G	L3/COL	L4	L5															
1789	1869	1939	2014	2159	2309	2429	2089	2234	2739																
9111	LG	LOUNGE CHAIR WIRE ROD BASE	<table border="1"> <thead> <tr> <th>A</th><th>B/COM</th><th>C</th><th>D</th><th>E</th><th>F</th><th>G</th><th>L3/COL</th><th>L4</th><th>L5</th> </tr> </thead> <tbody> <tr> <td>1870</td><td>1950</td><td>2020</td><td>2095</td><td>2240</td><td>2390</td><td>2510</td><td>2170</td><td>2315</td><td>2820</td> </tr> </tbody> </table>	A	B/COM	C	D	E	F	G	L3/COL	L4	L5	1870	1950	2020	2095	2240	2390	2510	2170	2315	2820	<ul style="list-style-type: none"> • Black or silver wire rod base • Two-tone upholstery available • Optional glides available-G16 & G17 	<p>WIDTH: 27.0 DEPTH: 29.0 HEIGHT: 33.0 SEAT WIDTH: 23.5 SEAT DEPTH: 19.0 SEAT HEIGHT: 16.0 BACK WIDTH: 23.5 BACK HEIGHT: 22.0 COM: 2.9 YD COL: 54.0 SQ FT WEIGHT: 29.0 LB</p>
A	B/COM	C	D	E	F	G	L3/COL	L4	L5																
1870	1950	2020	2095	2240	2390	2510	2170	2315	2820																
9131	LG	LOUNGE CHAIR SWIVEL BASE	<table border="1"> <thead> <tr> <th>A</th><th>B/COM</th><th>C</th><th>D</th><th>E</th><th>F</th><th>G</th><th>L3/COL</th><th>L4</th><th>L5</th> </tr> </thead> <tbody> <tr> <td>1968</td><td>2048</td><td>2118</td><td>2193</td><td>2338</td><td>2488</td><td>2608</td><td>2268</td><td>2413</td><td>2918</td> </tr> </tbody> </table>	A	B/COM	C	D	E	F	G	L3/COL	L4	L5	1968	2048	2118	2193	2338	2488	2608	2268	2413	2918	<ul style="list-style-type: none"> • Polished and black aluminum swivel base • Two-tone upholstery available • Adjustable nylon glides standard • Optional auto-return cylinder 	<p>WIDTH: 27.0 DEPTH: 29.0 HEIGHT: 33.0 SEAT WIDTH: 23.5 SEAT DEPTH: 19.0 SEAT HEIGHT: 16.0 BACK WIDTH: 23.5 BACK HEIGHT: 22.0 COM: 2.9 YD COL: 54.0 SQ FT WEIGHT: 34.0 LB</p>
A	B/COM	C	D	E	F	G	L3/COL	L4	L5																
1968	2048	2118	2193	2338	2488	2608	2268	2413	2918																
9121	LG	LOUNGE CHAIR 4 WOOD LEGS	<table border="1"> <thead> <tr> <th>A</th><th>B/COM</th><th>C</th><th>D</th><th>E</th><th>F</th><th>G</th><th>L3/COL</th><th>L4</th><th>L5</th> </tr> </thead> <tbody> <tr> <td>2153</td><td>2233</td><td>2303</td><td>2378</td><td>2523</td><td>2673</td><td>2793</td><td>2453</td><td>2598</td><td>3103</td> </tr> </tbody> </table>	A	B/COM	C	D	E	F	G	L3/COL	L4	L5	2153	2233	2303	2378	2523	2673	2793	2453	2598	3103	<ul style="list-style-type: none"> • Maple or walnut finish legs • Ships fully assembled only (AB or AC) • Two-tone upholstery available • Adjustable nylon glides standard 	<p>WIDTH: 27.0 DEPTH: 29.0 HEIGHT: 33.0 SEAT WIDTH: 23.5 SEAT DEPTH: 19.0 SEAT HEIGHT: 16.0 BACK WIDTH: 23.5 BACK HEIGHT: 22.0 COM: 2.9 YD COL: 54.0 SQ FT WEIGHT: 27.0 LB</p>
A	B/COM	C	D	E	F	G	L3/COL	L4	L5																
2153	2233	2303	2378	2523	2673	2793	2453	2598	3103																

BASE FINISHES

**BA20P/B
CY9N
NC**

Aluminum Swivel Base
BA20P - Polished
BA20B - Black
CY9N - Free Swivel
CY9NA - Auto Return

\$50

**BF/SF
NC**

4 Leg
BF - Black
SF - Silver

**MS/WA
NC**

Wood Leg Finishes
MS - Maple
WA - Walnut

**BF/SF
NC**

Wire Rod
BF - Black
SF - Silver

ADDITIONAL OPTIONS

**G18
NC**

Dome Glide
(9101 & 9104 only)

**G8
\$20**

Swivel Steel Glide
4 per Set (9101 & 9104 only)

**G9
\$20**

Swivel Nylon Glide
4 per Set (9101 & 9104 only)

**G10
\$20**

Swivel Felt Glide
4 per Set (9101 & 9104 only)

**G16
\$15**

Sled Base Clear Plastic Glide
(9101 only)
- 4 per set

**G17
\$25**

Sled Base Clear Plastic Glide
with Felt (9101 only) - 4
per set

**TT
\$100***

Two Tone Contrasting Upholstery (seat and back)
* If the two upholstery selections are of different grades,
the chair will price at the higher of the two grades.

lilly

classic, sophisticated and supremely comfortable

GSA SIN # 33721

- Lounge, side and stool seating
- Classic, sophisticated design
- Warranted to 300 lbs.



CREATING LILLY MODEL NUMBER

MODEL NUMBER CONTROL FRAME COLOR GRADE PACKAGING OPTIONS
9 1 6 5 - S T - **F** - -

PACKAGING NOTES

CODE	DESCRIPTION	LIST UPCHARGE
PAC	PARTIALLY ASSEMBLED IN CARTON	\$0
AC	ASSEMBLED IN CARTON	\$80

LILLY STOOLS SHIP UP TO 3 PAC

STOOLS

MODEL	CONTROL	DESCRIPTION	FABRIC/LEATHER	FEATURES	DIMENSIONS																																																		
9165	ST24	<p>COUNTER STOOL</p> <p>Use for work surfaces up to 36" high</p>	<table border="1"> <thead> <tr> <th>A</th> <th>B/COM</th> <th>C</th> <th>D</th> <th>E</th> <th>F</th> <th>G</th> <th>L3/COL</th> <th>L4</th> <th>L5</th> </tr> </thead> <tbody> <tr> <td>946</td> <td>976</td> <td>1006</td> <td>1031</td> <td>1076</td> <td>1121</td> <td>1146</td> <td>1081</td> <td>1116</td> <td>1271</td> </tr> <tr><td> </td><td> </td><td> </td><td> </td><td> </td><td> </td><td> </td><td> </td><td> </td><td> </td></tr> <tr><td> </td><td> </td><td> </td><td> </td><td> </td><td> </td><td> </td><td> </td><td> </td><td> </td></tr> <tr><td> </td><td> </td><td> </td><td> </td><td> </td><td> </td><td> </td><td> </td><td> </td><td> </td></tr> </tbody> </table>	A	B/COM	C	D	E	F	G	L3/COL	L4	L5	946	976	1006	1031	1076	1121	1146	1081	1116	1271																															<ul style="list-style-type: none"> • Upholstered seat • Sled frame with foot rest • 24" counter stool height 	<p>WIDTH: 20.0</p> <p>DEPTH: 16.0</p> <p>HEIGHT: 27.0</p> <p>SEAT WIDTH: 16.0</p> <p>SEAT DEPTH: 12.5</p> <p>SEAT HEIGHT: 24.0</p> <p>BACK WIDTH: 15.0</p> <p>BACK HEIGHT: 4.0</p> <p>COM: 0.7 YD</p> <p>COL: 12.0 SQ FT</p> <p>WEIGHT: 14.5 LB</p>
A	B/COM	C	D	E	F	G	L3/COL	L4	L5																																														
946	976	1006	1031	1076	1121	1146	1081	1116	1271																																														
9165	ST30	<p>BAR STOOL</p> <p>Use for work surfaces up to 42" high</p>	<table border="1"> <thead> <tr> <th>A</th> <th>B/COM</th> <th>C</th> <th>D</th> <th>E</th> <th>F</th> <th>G</th> <th>L3/COL</th> <th>L4</th> <th>L5</th> </tr> </thead> <tbody> <tr> <td>966</td> <td>996</td> <td>1026</td> <td>1051</td> <td>1096</td> <td>1141</td> <td>1166</td> <td>1101</td> <td>1136</td> <td>1291</td> </tr> <tr><td> </td><td> </td><td> </td><td> </td><td> </td><td> </td><td> </td><td> </td><td> </td><td> </td></tr> <tr><td> </td><td> </td><td> </td><td> </td><td> </td><td> </td><td> </td><td> </td><td> </td><td> </td></tr> <tr><td> </td><td> </td><td> </td><td> </td><td> </td><td> </td><td> </td><td> </td><td> </td><td> </td></tr> </tbody> </table>	A	B/COM	C	D	E	F	G	L3/COL	L4	L5	966	996	1026	1051	1096	1141	1166	1101	1136	1291																															<ul style="list-style-type: none"> • Upholstered seat • Sled frame with foot rest • 30" bar stool height 	<p>WIDTH: 20.5</p> <p>DEPTH: 17.0</p> <p>HEIGHT: 33.0</p> <p>SEAT WIDTH: 16.0</p> <p>SEAT DEPTH: 12.5</p> <p>SEAT HEIGHT: 30.5</p> <p>BACK WIDTH: 15.0</p> <p>BACK HEIGHT: 4.0</p> <p>COM: 0.7 YD</p> <p>COL: 12.0 SQ FT</p> <p>WEIGHT: 15.5 LB</p>
A	B/COM	C	D	E	F	G	L3/COL	L4	L5																																														
966	996	1026	1051	1096	1141	1166	1101	1136	1291																																														

FRAME COLORS

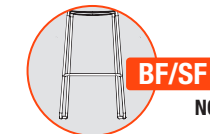

BF - Black
SF - Silver

ADDITIONAL OPTIONS



Sled Base Clear Plastic Glide
- 4 per set



Sled Base Clear Plastic Glide with Felt - 4 per set

link

transitional style with limitless possibilities

GSA SIN # 33721

- Side and guest seating
- Upholstered, mesh or black plastic back options
- 3" molded foam seat
- Wall-saver frame on select models
- Warranted to 300 lbs.



MESH BACK - MB

CREATING LINK MODEL NUMBER

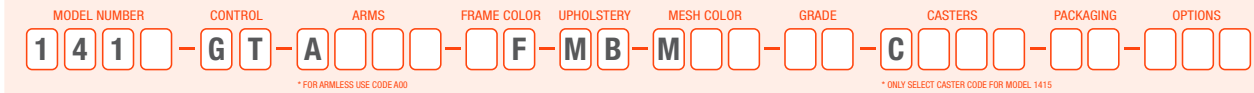

PACKAGING NOTES

CODE	DESCRIPTION	LIST UPCHARGE
AB	ASSEMBLED IN BAG	\$0
AC	ASSEMBLED IN CARTON	\$0

LINK MESH BACK SIDE CHAIRS SHIP UP TO 3 PER CARTON

MODEL	CONTROL	DESCRIPTION	ARM	FABRIC/LEATHER	FEATURES	DIMENSIONS			
							A	B/COM	C
1410	GT	GUEST SIDE Mesh back with upholstered seat	A00	635 665 695 735 785 840 910 810 835 935	<ul style="list-style-type: none"> • Wall-saver frame • Breathable mesh back • Stacks 4 high on the floor • Stacks 4 high on the optional stacking dolly • Not intended for use on vinyl surfaces (LVT, VCT) 	WIDTH: 25.5 DEPTH: 24.0 HEIGHT: 32.0 SEAT WIDTH: 20.0 SEAT DEPTH: 18.0 SEAT HEIGHT: 17.5 BACK WIDTH: 18.0 BACK HEIGHT: 16.0 COM: 1.3 YD COL: 12.0 SQ FT WEIGHT: 21.0 LB			
			A15B/G	705 735 765 805 855 910 980 880 905 1005					
1415	GT	GUEST SIDE WITH CASTERS Mesh back with upholstered seat	A00	680 710 740 780 830 885 955 855 880 980	<ul style="list-style-type: none"> • Breathable mesh back • Stacks 4 high on the floor • Stacks 4 high on the optional stacking dolly 	WIDTH: 25.5 DEPTH: 24.0 HEIGHT: 32.0 SEAT WIDTH: 20.0 SEAT DEPTH: 18.0 SEAT HEIGHT: 17.5 BACK WIDTH: 18.0 BACK HEIGHT: 16.0 COM: 1.3 YD COL: 12.0 SQ FT WEIGHT: 21.0 LB			
			A15B/G	750 780 810 850 900 955 1025 925 950 1050					

ARM OPTIONS

A15B/G
\$70

Soft Touch Arms
A15B - Black
A15G - Gray

CASTER OPTIONS

C12S
STD

Hard Floor and Carpet Casters

ADDITIONAL OPTIONS

DL5
\$399

Stacking Dolly
Stacks Chairs 4 High

FRAME COLORS

BLACK BF	SILVER SF
-------------	--------------

MESH COLORS

BLACK M11	GRAY M12	SILVER M13
--------------	-------------	---------------

CAUTION: Careless stacking of chairs may scratch and damage frames. Due to the nature of vinyl upholstery, stacking may cause impressions on the seat. 9to5 Seating does not warrant the effects of the stacking on vinyl upholstery.

link

transitional style with limitless possibilities

GSA SIN # 33721

- Side and guest seating
- Upholstered, mesh or black plastic back options
- 3" molded foam seat
- Wall-saver frame on select models
- Warranted to 300 lbs.



UPHOLSTERED BACK - UB

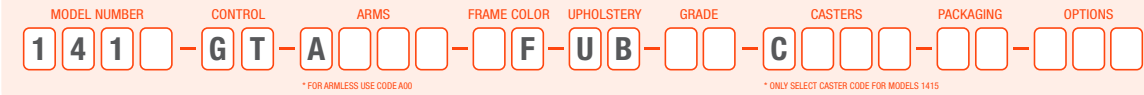

CREATING LINK MODEL NUMBER



PACKAGING NOTES

CODE	DESCRIPTION	LIST UPCHARGE
AB	ASSEMBLED IN BAG	\$0
AC	ASSEMBLED IN CARTON	\$0

LINK MESH BACK SIDE CHAIRS SHIP UP TO 3 PER CARTON

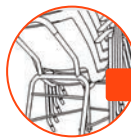
MODEL	CONTROL	DESCRIPTION	ARM	FABRIC/LEATHER										FEATURES	DIMENSIONS	ARM OPTIONS	CASTER OPTIONS
				A	B/COM	C	D	E	F	G	L3/COL	L4	L5				
1410	GT	GUEST SIDE Upholstered back with upholstered seat	A00	635	680	710	758	809	870	930	835	880	1035	<ul style="list-style-type: none"> • Wall-saver frame • Molded foam back • Stacks 4 high on the floor • Stacks 4 high on the optional stacking dolly • Not intended for use on vinyl surfaces (LVT, VCT) 	WIDTH: 25.5 DEPTH: 24.0 HEIGHT: 32.0 SEAT WIDTH: 20.0 SEAT DEPTH: 17.5 SEAT HEIGHT: 17.5 BACK WIDTH: 18.0 BACK HEIGHT: 16.0 COM: 1.3 YD COL: 29.0 SQ FT WEIGHT: 23.0 LB	 A15B/G \$70 Soft Touch Arms A15B - Black A15G - Gray	 C12S STD Hard Floor and Carpet Casters
			A15B/G	705	750	780	828	879	940	1000	905	950	1105				
1415	GT	GUEST SIDE WITH CASTERS Upholstered back with upholstered seat	A00	680	725	755	803	854	915	975	880	925	1080	<ul style="list-style-type: none"> • Molded foam back • Stacks 4 high on the floor • Stacks 4 high on the optional stacking dolly 	WIDTH: 25.5 DEPTH: 24.0 HEIGHT: 32.0 SEAT WIDTH: 20.0 SEAT DEPTH: 17.5 SEAT HEIGHT: 17.5 BACK WIDTH: 18.0 BACK HEIGHT: 16.0 COM: 1.3 YD COL: 29.0 SQ FT WEIGHT: 23.0 LB	 DL5 \$399 Stacking Dolly Stacks Chairs 4 High	FRAME COLORS BLACK BF SILVER SF
			A15B/G	750	795	825	873	924	985	1045	950	995	1150				

CAUTION: Careless stacking of chairs may scratch and damage frames. Due to the nature of vinyl upholstery, stacking may cause impressions on the seat. 9to5 Seating does not warrant the effects of the stacking on vinyl upholstery.

link

transitional style with limitless possibilities

GSA SIN # 33721

- Side and guest seating
- Upholstered, mesh or black plastic back options
- 3" molded foam seat
- Wall-saver frame on select models
- Warranted to 300 lbs.



PLASTIC BACK - PB

CREATING LINK MODEL NUMBER

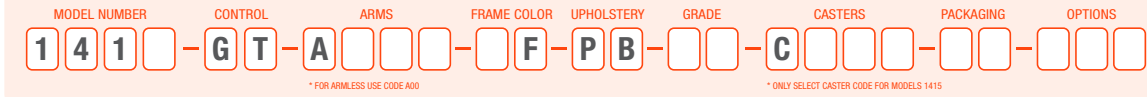

PACKAGING NOTES

CODE	DESCRIPTION	LIST UPCHARGE
AB	ASSEMBLED IN BAG	\$0
AC	ASSEMBLED IN CARTON	\$0

LINK MESH BACK SIDE CHAIRS SHIP UP TO 3 PER CARTON

MODEL	CONTROL	DESCRIPTION	ARM	FABRIC/LEATHER	FEATURES	DIMENSIONS	ARM OPTIONS	CASTER OPTIONS																														
1410	GT	GUEST SIDE Plastic back with upholstered seat	A00 A15B/G	<table border="1"> <thead> <tr> <th>A</th> <th>B/COM</th> <th>C</th> <th>D</th> <th>E</th> <th>F</th> <th>G</th> <th>L3/COL</th> <th>L4</th> <th>L5</th> </tr> </thead> <tbody> <tr> <td>600</td> <td>630</td> <td>660</td> <td>700</td> <td>750</td> <td>805</td> <td>875</td> <td>775</td> <td>800</td> <td>900</td> </tr> <tr> <td>670</td> <td>700</td> <td>730</td> <td>770</td> <td>820</td> <td>875</td> <td>945</td> <td>845</td> <td>870</td> <td>970</td> </tr> </tbody> </table>	A	B/COM	C	D	E	F	G	L3/COL	L4	L5	600	630	660	700	750	805	875	775	800	900	670	700	730	770	820	875	945	845	870	970	<ul style="list-style-type: none"> • Wall-saver frame • Perforated black plastic back • Stacks 4 high on the floor • Stacks 4 high on the optional stacking dolly • Not intended for use on vinyl surfaces (LVT, VCT) 	WIDTH: 25.5 DEPTH: 24.0 HEIGHT: 32.0 SEAT WIDTH: 20.0 SEAT DEPTH: 18.0 SEAT HEIGHT: 17.5 BACK WIDTH: 18.0 BACK HEIGHT: 16.0 COM: 1.3 YD COL: 12.0 SQ FT WEIGHT: 21.0 LB	A15B/G \$70 Soft Touch Arms A15B - Black A15G - Gray	C12S STD Hard Floor and Carpet Casters
A	B/COM	C	D	E	F	G	L3/COL	L4	L5																													
600	630	660	700	750	805	875	775	800	900																													
670	700	730	770	820	875	945	845	870	970																													
1415	GT	GUEST SIDE WITH CASTERS Plastic back with upholstered seat	A00 A1B/G	<table border="1"> <thead> <tr> <th>A</th> <th>B/COM</th> <th>C</th> <th>D</th> <th>E</th> <th>F</th> <th>G</th> <th>L3/COL</th> <th>L4</th> <th>L5</th> </tr> </thead> <tbody> <tr> <td>645</td> <td>675</td> <td>705</td> <td>745</td> <td>795</td> <td>850</td> <td>920</td> <td>820</td> <td>845</td> <td>945</td> </tr> <tr> <td>715</td> <td>745</td> <td>775</td> <td>815</td> <td>865</td> <td>920</td> <td>990</td> <td>890</td> <td>915</td> <td>1015</td> </tr> </tbody> </table>	A	B/COM	C	D	E	F	G	L3/COL	L4	L5	645	675	705	745	795	850	920	820	845	945	715	745	775	815	865	920	990	890	915	1015	<ul style="list-style-type: none"> • Perforated black plastic back • Stacks 4 high on the floor • Stacks 4 high on the optional stacking dolly 	WIDTH: 25.5 DEPTH: 24.0 HEIGHT: 32.0 SEAT WIDTH: 20.0 SEAT DEPTH: 18.0 SEAT HEIGHT: 17.5 BACK WIDTH: 18.0 BACK HEIGHT: 16.0 COM: 1.3 YD COL: 12.0 SQ FT WEIGHT: 21.0 LB	DL5 \$399 Stacking Dolly Stacks Chairs 4 High	
A	B/COM	C	D	E	F	G	L3/COL	L4	L5																													
645	675	705	745	795	850	920	820	845	945																													
715	745	775	815	865	920	990	890	915	1015																													

FRAME COLORS

BLACK BF	SILVER SF
-------------	--------------

CAUTION: Careless stacking of chairs may scratch and damage frames. Due to the nature of vinyl upholstery, stacking may cause impressions on the seat. 9to5 Seating does not warrant the effects of the stacking on vinyl upholstery.

logic

ergonomics, traditional task styling - an unmatched value

GSA SIN # 33721

- Task, stool, conference and executive seating
- Low-, mid- or high-back models
- Ratchet back lumbar height adjustment on select models
- Warranted to 300 lbs.



CREATING LOGIC MODEL NUMBER

MODEL NUMBER CONTROL ARMS GRADE BASE CASTERS PACKAGING OPTIONS

1 7 2 5 - [] [] - A [] [] - [] [] - B A 1 - C [] [] - [] [] - [] []

*FOR ARMLESS USE CODE A00

PACKAGING NOTES

CODE	DESCRIPTION	LIST UPCHARGE
AB	ASSEMBLED IN BAG	\$0
PAC	PARTIALLY ASSEMBLED IN CARTON	\$0
BAC	BACK ASSEMBLED IN CARTON	\$80

LOW-BACK

MODEL	CONTROL	DESCRIPTION	ARM	FABRIC	FEATURES	DIMENSIONS
1725	B2	LOW-BACK BASIC TASK WITH BACK DEPTH ADJUSTMENT	A00	A B/COM C D E F G 593 633 658 703 753 808 878	<ul style="list-style-type: none"> • 360° swivel • Pneumatic cylinder height adjustment 	WIDTH: 26.5 DEPTH: 26.5 HEIGHT: 38.5-49.5 SEAT WIDTH: 21.0 SEAT DEPTH: 18.5 SEAT HEIGHT: 18.0-23.5 BACK WIDTH: 19.5 BACK HEIGHT: 18.5 COM: 1.4 YD WEIGHT: 31.0 LB
	A4		693 733 758 803 853 908 978			
	A5		708 748 773 818 868 923 993			
	A6		753 793 818 863 913 968 1038			
	A7		768 808 833 878 928 983 1053			
	A16		718 758 783 828 878 933 1003			
	A90		828 868 893 938 988 1043 1113			
SEAT SLIDER (SS) - NOT AVAILABLE						
1725	S2	LOW-BACK SWIVEL TILT	A00	A B/COM C D E F G 638 678 703 748 798 853 923	<ul style="list-style-type: none"> • Adjustable back depth • Upright lock • Center knob tension adjustment • 360° swivel • Pneumatic cylinder height adjustment 	WIDTH: 26.5 DEPTH: 26.5 HEIGHT: 35.0-39.5 SEAT WIDTH: 21.0 SEAT DEPTH: 17.0 SEAT HEIGHT: 17.5-22.0 SEAT HEIGHT W/ SEAT SLIDER: 18.5-23.0 BACK WIDTH: 19.5 BACK HEIGHT: 18.5 COM: 1.4 YD WEIGHT: 34.0 LB
	A4		738 778 803 848 898 953 1023			
	A5		753 793 818 863 913 968 1038			
	A6		798 838 863 908 958 1013 1083			
	A7		813 853 878 923 973 1028 1098			
	A16		763 803 828 873 923 978 1048			
	A90		873 913 938 983 1033 1088 1158			
SEAT SLIDER - ADD \$60						
1725	P1	LOW-BACK POSTURE BACK	A00	A B/COM C D E F G 678 718 743 788 838 893 963	<ul style="list-style-type: none"> • Ratchet back lumbar adjustment • Infinite back angle adjustment with free float • 360° swivel • Pneumatic cylinder height adjustment 	WIDTH: 26.5 DEPTH: 26.5 HEIGHT: 35.0-42.5 SEAT WIDTH: 21.0 SEAT DEPTH: 17.0 SEAT HEIGHT: 17.5-22.0 SEAT HEIGHT W/ SEAT SLIDER: 18.5-23.0 BACK WIDTH: 19.5 BACK HEIGHT: 18.5-21.5 COM: 1.4 YD WEIGHT: 36.0 LB
	A4		778 818 843 888 938 993 1063			
	A5		793 833 858 903 953 1008 1078			
	A6		838 878 903 948 998 1053 1123			
	A7		853 893 918 963 1013 1068 1138			
	A16		803 843 868 913 963 1018 1088			
	A90		913 953 978 1023 1073 1128 1198			
SEAT SLIDER - ADD \$60						
1725	R1	LOW-BACK ROCKING TILT	A00	A B/COM C D E F G 688 728 753 798 848 903 973	<ul style="list-style-type: none"> • Ratchet back lumbar adjustment • Infinite back angle adjustment • Infinite tilt lock • Center knob tension adjustment • 360° swivel • Pneumatic cylinder height adjustment 	WIDTH: 26.5 DEPTH: 26.5 HEIGHT: 35.0-42.5 SEAT WIDTH: 21.0 SEAT DEPTH: 17.0 SEAT HEIGHT: 17.5-22.0 SEAT HEIGHT W/ SEAT SLIDER: 18.5-23.0 BACK WIDTH: 19.5 BACK HEIGHT: 18.5-21.5 COM: 1.4 YD WEIGHT: 38.0 LB
	A4		788 828 853 898 948 1003 1073			
	A5		803 843 868 913 963 1018 1088			
	A6		848 888 913 958 1008 1063 1133			
	A7		863 903 928 973 1023 1078 1148			
	A16		813 853 878 923 973 1028 1098			
	A90		923 963 988 1033 1083 1138 1208			
SEAT SLIDER - ADD \$60						





ARM OPTIONS

 <p>A4 \$100</p> <p>Height Adjustable Arm</p>	 <p>A5 \$115</p> <p>Height/Width Adjustable Arm</p>	 <p>A6 \$155</p> <p>Height Adjustable Pivot/Slide Arm with Ura-Soft Sliding Arm Pads</p>
 <p>A7 \$175</p> <p>Height/Width Adjustable Pivot/Slide Arm with Ura-Soft Sliding Arm Pads</p>	 <p>A16 \$125</p> <p>Soft Touch C-Shape Arm w/ Upholstered Pad</p>	 <p>A90 \$235</p> <p>Height/Width Adjustable Breakaway Arm</p>

CASTER OPTIONS

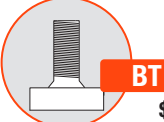
 <p>C1 STD</p> <p>Carpet Casters</p>	 <p>C1S \$35</p> <p>Hard Floor and Carpet Casters</p>	 <p>C2S \$35</p> <p>Decompression Hard Floor and Soft Carpet Casters</p>
--	---	--

ADDITIONAL OPTIONS

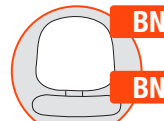
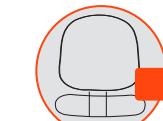
 <p>BT \$15</p> <p>Replace Knob with Bolt (For S2 and B2 Controls Only)</p>	 <p>EF1 \$30</p> <p>1" Extra Foam on Seat. If EF1 is selected, cannot use MF1 in addition.</p>	 <p>MF1 \$50</p> <p>1" Visco Elastic Memory Foam on Seat. If MF1 is selected, cannot use EF1 in addition.</p>
 <p>SS \$60</p> <p>Seat Slider 2.5" Side Paddle Activated</p>	 <p>BN1 \$35 BN2 N/C</p> <p>Upholstered Outer Back in Black Ballistic Nylon BN1 - with Grade A Only BN2 - with Grade B and Up</p>	 <p>EP \$60</p> <p>Edge Protector - a Clear Vinyl Tube Placed Around the Edge of the Back Cushion</p>

logic

ergonomics, traditional task styling - an unmatched value

GSA SIN # 33721

- Task, stool, conference and executive seating
- Low-, mid- or high-back models
- Ratchet back lumbar height adjustment on select models
- Warranted to 300 lbs.



CREATING LOGIC MODEL NUMBER



PACKAGING NOTES

CODE	DESCRIPTION	LIST UPCHARGE
AB	ASSEMBLED IN BAG	\$0
PAC	PARTIALLY ASSEMBLED IN CARTON	\$0
BAC	BACK ASSEMBLED IN CARTON	\$80

LOW-BACK

MODEL CONTROL DESCRIPTION

ARM

FABRIC

FEATURES

DIMENSIONS

ARM OPTIONS

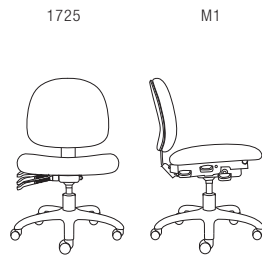

LOW-BACK MULTI-FUNCTION

Formerly Precept Series

	A	B/COM	C	D	E	F	G
A00	738	778	803	848	898	953	1023
A4	838	878	903	948	998	1053	1123
A5	853	893	918	963	1013	1068	1138
A6	898	938	963	1008	1058	1113	1183
A7	913	953	978	1023	1073	1128	1198
A16	863	903	928	973	1023	1078	1148
A90	973	1013	1038	1083	1133	1188	1258

SEAT SLIDER (SS) - ADD \$60

- Ratchet back lumbar adjustment
- Infinite back angle adjustment
- 6° forward tilt
- Center knob tension adjustment
- 360° swivel
- Pneumatic cylinder height adjustment

WIDTH: 26.5
 DEPTH: 26.5
 HEIGHT: 35.0-42.5
 SEAT WIDTH: 21.0
 SEAT DEPTH: 17.0
 SEAT HEIGHT: 17.5-22.0
 SEAT HEIGHT W/ SEAT SLIDER: 18.5-23
 BACK WIDTH: 19.5
 BACK HEIGHT: 18.5-21.5
 COM: 1.4 YD
 WEIGHT: 39.0 LB



Height Adjustable Arm

Height/Width Adjustable Arm

Height Adjustable Pivot/Slide Arm with Ura-Soft Sliding Arm Pads

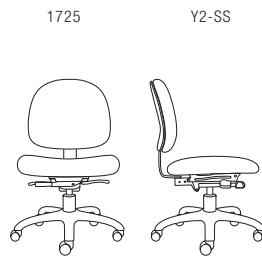

LOW-BACK HEAVY DUTY SYNCHRO TILT WITH SEAT SLIDER

Formerly Precept Series

	A	B/COM	C	D	E	F	G
A00	778	818	843	888	938	993	1063
A4	878	918	943	988	1038	1093	1163
A5	893	933	958	1003	1053	1108	1178
A6	938	978	1003	1048	1098	1153	1223
A7	953	993	1018	1063	1113	1168	1238
A16	903	943	968	1013	1063	1118	1188
A90	1013	1053	1078	1123	1173	1228	1298

SEAT SLIDER (SS) - STANDARD

- Ratchet back lumbar adjustment
- Seat slider standard
- 4-position tilt lock
- Side knob tension control
- 2:1 back-to-seat tilt ratio
- 360° swivel
- Pneumatic cylinder height adjustment

WIDTH: 26.5
 DEPTH: 26.5
 HEIGHT: 33.5-41.0
 SEAT WIDTH: 21.0
 SEAT DEPTH: 17.0-19.5
 SEAT HEIGHT: 19.0-23.5
 BACK WIDTH: 19.5
 BACK HEIGHT: 18.5-21.5
 COM: 1.4 YD
 WEIGHT: 41.0 LB



Height/Width Adjustable Pivot/Slide Arm with Ura-Soft Sliding Arm Pads

Soft Touch C-Shape Arm w/ Upholstered Pad

Height/Width Adjustable Breakaway Arm

CASTER OPTIONS



Carpet Casters

Hard Floor and Carpet Casters

Decompression Hard Floor and Soft Carpet Caster

ADDITIONAL OPTIONS



Replace Knob with Bolt (For S2 and B2 Controls Only)

1" Extra Foam on Seat. If EF1 is selected, cannot use MF1 in addition.

Edge Protector - a Clear Vinyl Tube Placed Around the Edge of the Back Cushion



1" Visco Elastic Memory Foam on Seat. If MF1 is selected, cannot use EF1 in addition.

Seat Slider 2.5" Side Paddle Activated

Upholstered Outer Back in Black Ballistic Nylon BN1 - with Grade A Only BN2 - with Grade B and Up

logic

ergonomics, traditional task styling - an unmatched value

GSA SIN # 33721

- Task, stool, conference and executive seating
- Low-, mid- or high-back models
- Ratchet back lumbar height adjustment on select models
- Warranted to 300 lbs.



CREATING LOGIC MODEL NUMBER

MODEL NUMBER CONTROL ARMS GRADE BASE CASTERS PACKAGING OPTIONS

1 7 2 - - A - - B A 1 - C - - - -

*FOR ARMS/LESS USE CODE A00

PACKAGING NOTES

CODE	DESCRIPTION	LIST UPCHARGE
AB	ASSEMBLED IN BAG	\$0
PAC	PARTIALLY ASSEMBLED IN CARTON	\$0
BAC	BACK ASSEMBLED IN CARTON	\$80

LOW-BACK STOOLS

MODEL	CONTROL	DESCRIPTION	ARM	FABRIC	FEATURES	DIMENSIONS	ARM OPTIONS																																																								
1726	B2	LOW-BACK 10" STOOL BASIC TASK WITH BACK DEPTH ADJUSTMENT Use for work surfaces up to 42" high Formerly Precept Series	A00 A4 A5 A6 A7 A16 A90	<table border="1"> <thead> <tr> <th>A</th> <th>B/COM</th> <th>C</th> <th>D</th> <th>E</th> <th>F</th> <th>G</th> </tr> </thead> <tbody> <tr><td>718</td><td>758</td><td>783</td><td>828</td><td>878</td><td>933</td><td>1003</td></tr> <tr><td>818</td><td>858</td><td>883</td><td>928</td><td>978</td><td>1033</td><td>1103</td></tr> <tr><td>833</td><td>873</td><td>898</td><td>943</td><td>993</td><td>1048</td><td>1118</td></tr> <tr><td>878</td><td>918</td><td>943</td><td>988</td><td>1038</td><td>1093</td><td>1163</td></tr> <tr><td>893</td><td>933</td><td>958</td><td>1003</td><td>1053</td><td>1108</td><td>1178</td></tr> <tr><td>843</td><td>883</td><td>908</td><td>953</td><td>1003</td><td>1058</td><td>1128</td></tr> <tr><td>953</td><td>993</td><td>1018</td><td>1063</td><td>1113</td><td>1168</td><td>1238</td></tr> </tbody> </table>	A	B/COM	C	D	E	F	G	718	758	783	828	878	933	1003	818	858	883	928	978	1033	1103	833	873	898	943	993	1048	1118	878	918	943	988	1038	1093	1163	893	933	958	1003	1053	1108	1178	843	883	908	953	1003	1058	1128	953	993	1018	1063	1113	1168	1238	<ul style="list-style-type: none"> • Height-adjustable 20" diameter foot ring • Adjustable back depth • 360° swivel • Pneumatic cylinder height adjustment 	WIDTH: 26.5 DEPTH: 26.5 HEIGHT: 42.5-52.5 SEAT WIDTH: 21.0 SEAT DEPTH: 17.0 SEAT HEIGHT: 25.0-35.0 BACK WIDTH: 19.5 BACK HEIGHT: 18.5 COM: 1.4 YD WEIGHT: 32.0 LB	A4 \$100 A5 \$115 A6 \$160 A7 \$175 A16 \$125 A90 \$235
A	B/COM	C	D	E	F	G																																																									
718	758	783	828	878	933	1003																																																									
818	858	883	928	978	1033	1103																																																									
833	873	898	943	993	1048	1118																																																									
878	918	943	988	1038	1093	1163																																																									
893	933	958	1003	1053	1108	1178																																																									
843	883	908	953	1003	1058	1128																																																									
953	993	1018	1063	1113	1168	1238																																																									
1726	P1	LOW-BACK 10" STOOL POSTURE BACK Use for work surfaces up to 42" high Formerly Precept Series	A00 A4 A5 A6 A7 A16 A90	<table border="1"> <thead> <tr> <th>A</th> <th>B/COM</th> <th>C</th> <th>D</th> <th>E</th> <th>F</th> <th>G</th> </tr> </thead> <tbody> <tr><td>803</td><td>843</td><td>868</td><td>913</td><td>963</td><td>1018</td><td>1088</td></tr> <tr><td>903</td><td>943</td><td>968</td><td>1013</td><td>1063</td><td>1118</td><td>1188</td></tr> <tr><td>918</td><td>958</td><td>983</td><td>1028</td><td>1078</td><td>1133</td><td>1203</td></tr> <tr><td>963</td><td>1003</td><td>1028</td><td>1073</td><td>1123</td><td>1178</td><td>1248</td></tr> <tr><td>978</td><td>1018</td><td>1043</td><td>1088</td><td>1138</td><td>1193</td><td>1263</td></tr> <tr><td>928</td><td>968</td><td>993</td><td>1038</td><td>1088</td><td>1143</td><td>1213</td></tr> <tr><td>1038</td><td>1078</td><td>1103</td><td>1148</td><td>1198</td><td>1253</td><td>1323</td></tr> </tbody> </table>	A	B/COM	C	D	E	F	G	803	843	868	913	963	1018	1088	903	943	968	1013	1063	1118	1188	918	958	983	1028	1078	1133	1203	963	1003	1028	1073	1123	1178	1248	978	1018	1043	1088	1138	1193	1263	928	968	993	1038	1088	1143	1213	1038	1078	1103	1148	1198	1253	1323	<ul style="list-style-type: none"> • Ratchet back lumbar adjustment • Height-adjustable 20" diameter foot ring • Infinite back angle adjustment with free float • 360° swivel • Pneumatic cylinder height adjustment 	WIDTH: 26.5 DEPTH: 26.5 HEIGHT: 42.5-55.5 SEAT WIDTH: 21.0 SEAT DEPTH: 17.0 SEAT HEIGHT: 25.0-35.0 BACK WIDTH: 19.5 BACK HEIGHT: 18.5-21.5 COM: 1.4 YD WEIGHT: 36.0 LB	C1 STD C1S \$35 C2S \$35
A	B/COM	C	D	E	F	G																																																									
803	843	868	913	963	1018	1088																																																									
903	943	968	1013	1063	1118	1188																																																									
918	958	983	1028	1078	1133	1203																																																									
963	1003	1028	1073	1123	1178	1248																																																									
978	1018	1043	1088	1138	1193	1263																																																									
928	968	993	1038	1088	1143	1213																																																									
1038	1078	1103	1148	1198	1253	1323																																																									
1728	B2	LOW-BACK 8" STOOL BASIC TASK WITH BACK DEPTH ADJUSTMENT Use for work surfaces up to 36" high Formerly Precept Series	A00 A4 A5 A6 A7 A16 A90	<table border="1"> <thead> <tr> <th>A</th> <th>B/COM</th> <th>C</th> <th>D</th> <th>E</th> <th>F</th> <th>G</th> </tr> </thead> <tbody> <tr><td>718</td><td>758</td><td>783</td><td>828</td><td>878</td><td>933</td><td>1003</td></tr> <tr><td>818</td><td>858</td><td>883</td><td>928</td><td>978</td><td>1033</td><td>1103</td></tr> <tr><td>833</td><td>873</td><td>898</td><td>943</td><td>993</td><td>1048</td><td>1118</td></tr> <tr><td>878</td><td>918</td><td>943</td><td>988</td><td>1038</td><td>1093</td><td>1163</td></tr> <tr><td>893</td><td>933</td><td>958</td><td>1003</td><td>1053</td><td>1108</td><td>1178</td></tr> <tr><td>843</td><td>883</td><td>908</td><td>953</td><td>1003</td><td>1058</td><td>1128</td></tr> <tr><td>953</td><td>993</td><td>1018</td><td>1063</td><td>1113</td><td>1168</td><td>1238</td></tr> </tbody> </table>	A	B/COM	C	D	E	F	G	718	758	783	828	878	933	1003	818	858	883	928	978	1033	1103	833	873	898	943	993	1048	1118	878	918	943	988	1038	1093	1163	893	933	958	1003	1053	1108	1178	843	883	908	953	1003	1058	1128	953	993	1018	1063	1113	1168	1238	<ul style="list-style-type: none"> • Height-adjustable 20" diameter foot ring • Adjustable back depth • 360° swivel • Pneumatic cylinder height adjustment 	WIDTH: 26.5 DEPTH: 26.5 HEIGHT: 38.5-46.5 SEAT WIDTH: 21.0 SEAT DEPTH: 17.0 SEAT HEIGHT: 21.0-29.0 BACK WIDTH: 19.5 BACK HEIGHT: 18.5 COM: 1.4 YD WEIGHT: 31.0 LB	BT \$15 EF1 \$30 MF1 \$50
A	B/COM	C	D	E	F	G																																																									
718	758	783	828	878	933	1003																																																									
818	858	883	928	978	1033	1103																																																									
833	873	898	943	993	1048	1118																																																									
878	918	943	988	1038	1093	1163																																																									
893	933	958	1003	1053	1108	1178																																																									
843	883	908	953	1003	1058	1128																																																									
953	993	1018	1063	1113	1168	1238																																																									
1728	P1	LOW-BACK 8" STOOL POSTURE BACK Use for work surfaces up to 36" high Formerly Precept Series	A00 A4 A5 A6 A7 A16 A90	<table border="1"> <thead> <tr> <th>A</th> <th>B/COM</th> <th>C</th> <th>D</th> <th>E</th> <th>F</th> <th>G</th> </tr> </thead> <tbody> <tr><td>803</td><td>843</td><td>868</td><td>913</td><td>963</td><td>1018</td><td>1088</td></tr> <tr><td>903</td><td>943</td><td>968</td><td>1013</td><td>1063</td><td>1118</td><td>1188</td></tr> <tr><td>918</td><td>958</td><td>983</td><td>1028</td><td>1078</td><td>1133</td><td>1203</td></tr> <tr><td>963</td><td>1003</td><td>1028</td><td>1073</td><td>1123</td><td>1178</td><td>1248</td></tr> <tr><td>978</td><td>1018</td><td>1043</td><td>1088</td><td>1138</td><td>1193</td><td>1263</td></tr> <tr><td>928</td><td>968</td><td>993</td><td>1038</td><td>1088</td><td>1143</td><td>1213</td></tr> <tr><td>1038</td><td>1078</td><td>1103</td><td>1148</td><td>1198</td><td>1253</td><td>1323</td></tr> </tbody> </table>	A	B/COM	C	D	E	F	G	803	843	868	913	963	1018	1088	903	943	968	1013	1063	1118	1188	918	958	983	1028	1078	1133	1203	963	1003	1028	1073	1123	1178	1248	978	1018	1043	1088	1138	1193	1263	928	968	993	1038	1088	1143	1213	1038	1078	1103	1148	1198	1253	1323	<ul style="list-style-type: none"> • Ratchet back lumbar adjustment • Height-adjustable 20" diameter foot ring • Infinite back angle adjustment with free float • 360° swivel • Pneumatic cylinder height adjustment 	WIDTH: 26.5 DEPTH: 26.5 HEIGHT: 38.5-49.5 SEAT WIDTH: 21.0 SEAT DEPTH: 17.0 SEAT HEIGHT: 21.0-29.0 BACK WIDTH: 19.5 BACK HEIGHT: 18.5-21.5 COM: 1.4 YD WEIGHT: 35.0 LB	BN1 \$35 BN2 N/C EP \$60
A	B/COM	C	D	E	F	G																																																									
803	843	868	913	963	1018	1088																																																									
903	943	968	1013	1063	1118	1188																																																									
918	958	983	1028	1078	1133	1203																																																									
963	1003	1028	1073	1123	1178	1248																																																									
978	1018	1043	1088	1138	1193	1263																																																									
928	968	993	1038	1088	1143	1213																																																									
1038	1078	1103	1148	1198	1253	1323																																																									

logic

ergonomics, traditional task styling - an unmatched value

MID-BACK

GSA SIN # 33721

- Task, stool, conference and executive seating
- Low-, mid- or high-back models
- Ratchet back lumbar height adjustment on select models
- Heavy duty multi-shift 24/7 optional (350 lb. rating)
- Warranted to 300 lbs.



CREATING LOGIC MODEL NUMBER



PACKAGING NOTES

CODE	DESCRIPTION	LIST UPCHARGE
AB	ASSEMBLED IN BAG	\$0
PAC	PARTIALLY ASSEMBLED IN CARTON	\$0
BAC	BACK ASSEMBLED IN CARTON	\$80

MODEL	CONTROL	DESCRIPTION	ARM	FABRIC	FEATURES	DIMENSIONS	ARM OPTIONS	CASTER OPTIONS	ADDITIONAL OPTIONS						
1760	S2	MID-BACK SWIVEL TILT	A00	A B/COM C D E F G 734 789 829 884 973 1059 1144	<ul style="list-style-type: none"> • Adjustable back depth • Upright lock • Center knob tension adjustment • 360° swivel • Pneumatic cylinder height adjustment 	WIDTH: 26.5 DEPTH: 26.0 HEIGHT: 39.0-43.5 SEAT WIDTH: 21.0 SEAT DEPTH: 16.5 SEAT HEIGHT: 17.0-21.5 SEAT HEIGHT W/ SEAT SLIDER: 18-22.5 BACK WIDTH: 20.0 BACK HEIGHT: 20.5-23.5 COM: 1.6 YD WEIGHT: 28.5 LB	A4 \$100 Height Adjustable Arm A5 \$115 Height/Width Adjustable Arm A6 \$160 Height Adjustable Pivot/Slide Arm with Ura-Soft Sliding Arm Pads A7 \$175 Height/Width Adjustable Pivot/Slide Arm with Ura-Soft Sliding Arm Pads A16 \$125 Soft Touch C-Shape Arm w/ Upholstered Pad A90 \$235 Height/Width Adjustable Breakaway Arm	C1 STD Carpet Casters C1S \$35 Hard Floor and Carpet Casters C2S \$35 Decompression Hard Floor and Soft Carpet Caster	BT \$15 Replace Knob with Bolt (For S2 and B2 Controls Only) EF1 \$30 1" Extra Foam on Seat. If EF1 is selected, cannot use MF1 in addition. MF1 \$50 1" Visco Elastic Memory Foam on Seat. If MF1 is selected, cannot use EF1 in addition.						
	A4		834 889 929 984 1073 1159 1244	WIDTH: 26.5 DEPTH: 26.0 HEIGHT: 39.0-46.5 SEAT WIDTH: 21.0 SEAT DEPTH: 16.5 SEAT HEIGHT: 16.5-21.0 SEAT HEIGHT W/ SEAT SLIDER: 17.5-22.0 BACK WIDTH: 20.0 BACK HEIGHT: 20.5-23.5 COM: 1.6 YD WEIGHT: 34.0 LB						EP \$60 Edge Protector - a Clear Vinyl Tube Placed Around the Edge of the Back Cushion SS \$60 Seat Slider 2.5" Side Paddle Activated BN1 \$35 Upholstered Outer Back in Black Ballistic Nylon BN2 N/C Upholstered Outer Back in Black Ballistic Nylon HD \$125 Heavy Duty Multi-Shift Upgrade 350 lb. Includes BA2 Aluminum Base and C4 60mm Casters; Available with M1 and Y2 Only					
	A5		849 904 944 999 1088 1174 1259								<ul style="list-style-type: none"> • Ratchet back lumbar adjustment • Infinite back angle adjustment • Infinite tilt lock • Center knob tension adjustment • 360° swivel • Pneumatic cylinder height adjustment 	WIDTH: 26.5 DEPTH: 26.0 HEIGHT: 37.5-45.0 SEAT WIDTH: 21.0 SEAT DEPTH: 17.5 SEAT HEIGHT: 18.5-23.0 SEAT HEIGHT W/ SEAT SLIDER: 19.5-24.0 BACK WIDTH: 20.0 BACK HEIGHT: 19.0-22.0 COM: 1.6 YD WEIGHT: 41.0 LB			
	A6		894 949 989 1044 1133 1219 1304										WIDTH: 26.5 DEPTH: 26.0 HEIGHT: 39.0-46.5 SEAT WIDTH: 21.0 SEAT DEPTH: 16.5 SEAT HEIGHT: 16.5-21.0 SEAT HEIGHT W/ SEAT SLIDER: 17.5-22.0 BACK WIDTH: 20.0 BACK HEIGHT: 20.5-23.5 COM: 1.6 YD WEIGHT: 34.0 LB		
	A7		909 964 1004 1059 1148 1234 1319											WIDTH: 26.5 DEPTH: 26.0 HEIGHT: 39.0-46.5 SEAT WIDTH: 21.0 SEAT DEPTH: 16.5 SEAT HEIGHT: 16.5-21.0 SEAT HEIGHT W/ SEAT SLIDER: 17.5-22.0 BACK WIDTH: 20.0 BACK HEIGHT: 20.5-23.5 COM: 1.6 YD WEIGHT: 34.0 LB	
	A16		859 914 954 1009 1098 1184 1269												WIDTH: 26.5 DEPTH: 26.0 HEIGHT: 39.0-46.5 SEAT WIDTH: 21.0 SEAT DEPTH: 16.5 SEAT HEIGHT: 16.5-21.0 SEAT HEIGHT W/ SEAT SLIDER: 17.5-22.0 BACK WIDTH: 20.0 BACK HEIGHT: 20.5-23.5 COM: 1.6 YD WEIGHT: 34.0 LB
	A90		969 1024 1064 1119 1208 1294 1379												
	SEAT SLIDER (SS) - ADD \$60														
1760	R1	MID-BACK ROCKING TILT	A00	A B/COM C D E F G 784 839 879 934 1023 1109 1194	<ul style="list-style-type: none"> • Ratchet back lumbar adjustment • Infinite back angle adjustment • Infinite tilt lock • Center knob tension adjustment • 360° swivel • Pneumatic cylinder height adjustment 	WIDTH: 26.5 DEPTH: 26.0 HEIGHT: 39.0-46.5 SEAT WIDTH: 21.0 SEAT DEPTH: 16.5 SEAT HEIGHT: 16.5-21.0 SEAT HEIGHT W/ SEAT SLIDER: 17.5-22.0 BACK WIDTH: 20.0 BACK HEIGHT: 20.5-23.5 COM: 1.6 YD WEIGHT: 34.0 LB	EP \$60 Edge Protector - a Clear Vinyl Tube Placed Around the Edge of the Back Cushion SS \$60 Seat Slider 2.5" Side Paddle Activated BN1 \$35 Upholstered Outer Back in Black Ballistic Nylon BN2 N/C Upholstered Outer Back in Black Ballistic Nylon HD \$125 Heavy Duty Multi-Shift Upgrade 350 lb. Includes BA2 Aluminum Base and C4 60mm Casters; Available with M1 and Y2 Only	C1 STD Carpet Casters C1S \$35 Hard Floor and Carpet Casters C2S \$35 Decompression Hard Floor and Soft Carpet Caster	BT \$15 Replace Knob with Bolt (For S2 and B2 Controls Only) EF1 \$30 1" Extra Foam on Seat. If EF1 is selected, cannot use MF1 in addition. MF1 \$50 1" Visco Elastic Memory Foam on Seat. If MF1 is selected, cannot use EF1 in addition.						
	A4		884 939 979 1034 1123 1209 1294	WIDTH: 26.5 DEPTH: 26.0 HEIGHT: 39.0-46.5 SEAT WIDTH: 21.0 SEAT DEPTH: 16.5 SEAT HEIGHT: 16.5-21.0 SEAT HEIGHT W/ SEAT SLIDER: 17.5-22.0 BACK WIDTH: 20.0 BACK HEIGHT: 20.5-23.5 COM: 1.6 YD WEIGHT: 34.0 LB											
	A5		899 954 994 1049 1138 1224 1309							<ul style="list-style-type: none"> • Ratchet back lumbar adjustment • 4-position tilt lock • Side knob tension adjustment • 2:1 back-to-seat tilt ratio • 360° swivel • Pneumatic cylinder height adjustment 	WIDTH: 26.5 DEPTH: 26.0 HEIGHT: 37.5-45.0 SEAT WIDTH: 21.0 SEAT DEPTH: 17.5 SEAT HEIGHT: 18.5-23.0 SEAT HEIGHT W/ SEAT SLIDER: 19.5-24.0 BACK WIDTH: 20.0 BACK HEIGHT: 19.0-22.0 COM: 1.6 YD WEIGHT: 41.0 LB				
	A6		944 999 1039 1094 1183 1269 1354									WIDTH: 26.5 DEPTH: 26.0 HEIGHT: 39.0-46.5 SEAT WIDTH: 21.0 SEAT DEPTH: 16.5 SEAT HEIGHT: 16.5-21.0 SEAT HEIGHT W/ SEAT SLIDER: 17.5-22.0 BACK WIDTH: 20.0 BACK HEIGHT: 20.5-23.5 COM: 1.6 YD WEIGHT: 34.0 LB			
	A7		959 1014 1054 1109 1198 1284 1369										WIDTH: 26.5 DEPTH: 26.0 HEIGHT: 39.0-46.5 SEAT WIDTH: 21.0 SEAT DEPTH: 16.5 SEAT HEIGHT: 16.5-21.0 SEAT HEIGHT W/ SEAT SLIDER: 17.5-22.0 BACK WIDTH: 20.0 BACK HEIGHT: 20.5-23.5 COM: 1.6 YD WEIGHT: 34.0 LB		
	A16		909 964 1004 1059 1148 1234 1319											WIDTH: 26.5 DEPTH: 26.0 HEIGHT: 39.0-46.5 SEAT WIDTH: 21.0 SEAT DEPTH: 16.5 SEAT HEIGHT: 16.5-21.0 SEAT HEIGHT W/ SEAT SLIDER: 17.5-22.0 BACK WIDTH: 20.0 BACK HEIGHT: 20.5-23.5 COM: 1.6 YD WEIGHT: 34.0 LB	
	A90		1019 1074 1114 1169 1258 1344 1429												WIDTH: 26.5 DEPTH: 26.0 HEIGHT: 39.0-46.5 SEAT WIDTH: 21.0 SEAT DEPTH: 16.5 SEAT HEIGHT: 16.5-21.0 SEAT HEIGHT W/ SEAT SLIDER: 17.5-22.0 BACK WIDTH: 20.0 BACK HEIGHT: 20.5-23.5 COM: 1.6 YD WEIGHT: 34.0 LB
	SEAT SLIDER (SS) - ADD \$60														
1760	Y2	MID-BACK HEAVY DUTY SYNCHRO TILT	A00	A B/COM C D E F G 814 869 909 964 1053 1139 1224	<ul style="list-style-type: none"> • Ratchet back lumbar adjustment • 4-position tilt lock • Side knob tension adjustment • 2:1 back-to-seat tilt ratio • 360° swivel • Pneumatic cylinder height adjustment 	WIDTH: 26.5 DEPTH: 26.0 HEIGHT: 37.5-45.0 SEAT WIDTH: 21.0 SEAT DEPTH: 17.5 SEAT HEIGHT: 18.5-23.0 SEAT HEIGHT W/ SEAT SLIDER: 19.5-24.0 BACK WIDTH: 20.0 BACK HEIGHT: 19.0-22.0 COM: 1.6 YD WEIGHT: 41.0 LB	EP \$60 Edge Protector - a Clear Vinyl Tube Placed Around the Edge of the Back Cushion SS \$60 Seat Slider 2.5" Side Paddle Activated BN1 \$35 Upholstered Outer Back in Black Ballistic Nylon BN2 N/C Upholstered Outer Back in Black Ballistic Nylon HD \$125 Heavy Duty Multi-Shift Upgrade 350 lb. Includes BA2 Aluminum Base and C4 60mm Casters; Available with M1 and Y2 Only	C1 STD Carpet Casters C1S \$35 Hard Floor and Carpet Casters C2S \$35 Decompression Hard Floor and Soft Carpet Caster	BT \$15 Replace Knob with Bolt (For S2 and B2 Controls Only) EF1 \$30 1" Extra Foam on Seat. If EF1 is selected, cannot use MF1 in addition. MF1 \$50 1" Visco Elastic Memory Foam on Seat. If MF1 is selected, cannot use EF1 in addition.						
	A4		914 969 1009 1064 1153 1239 1324	WIDTH: 26.5 DEPTH: 26.0 HEIGHT: 37.5-45.0 SEAT WIDTH: 21.0 SEAT DEPTH: 17.5 SEAT HEIGHT: 18.5-23.0 SEAT HEIGHT W/ SEAT SLIDER: 19.5-24.0 BACK WIDTH: 20.0 BACK HEIGHT: 19.0-22.0 COM: 1.6 YD WEIGHT: 41.0 LB											
	A5		929 984 1024 1079 1168 1254 1339							<ul style="list-style-type: none"> • Ratchet back lumbar adjustment • Infinite back angle adjustment • Infinite tilt lock • Center knob tension adjustment • 360° swivel • Pneumatic cylinder height adjustment 	WIDTH: 26.5 DEPTH: 26.0 HEIGHT: 39.0-46.5 SEAT WIDTH: 21.0 SEAT DEPTH: 16.5 SEAT HEIGHT: 16.5-21.0 SEAT HEIGHT W/ SEAT SLIDER: 17.5-22.0 BACK WIDTH: 20.0 BACK HEIGHT: 20.5-23.5 COM: 1.6 YD WEIGHT: 34.0 LB				
	A6		974 1029 1069 1124 1213 1299 1384									WIDTH: 26.5 DEPTH: 26.0 HEIGHT: 39.0-46.5 SEAT WIDTH: 21.0 SEAT DEPTH: 16.5 SEAT HEIGHT: 16.5-21.0 SEAT HEIGHT W/ SEAT SLIDER: 17.5-22.0 BACK WIDTH: 20.0 BACK HEIGHT: 20.5-23.5 COM: 1.6 YD WEIGHT: 34.0 LB			
	A7		989 1044 1084 1139 1228 1314 1399										WIDTH: 26.5 DEPTH: 26.0 HEIGHT: 39.0-46.5 SEAT WIDTH: 21.0 SEAT DEPTH: 16.5 SEAT HEIGHT: 16.5-21.0 SEAT HEIGHT W/ SEAT SLIDER: 17.5-22.0 BACK WIDTH: 20.0 BACK HEIGHT: 20.5-23.5 COM: 1.6 YD WEIGHT: 34.0 LB		
	A16		939 994 1034 1089 1178 1264 1349											WIDTH: 26.5 DEPTH: 26.0 HEIGHT: 39.0-46.5 SEAT WIDTH: 21.0 SEAT DEPTH: 16.5 SEAT HEIGHT: 16.5-21.0 SEAT HEIGHT W/ SEAT SLIDER: 17.5-22.0 BACK WIDTH: 20.0 BACK HEIGHT: 20.5-23.5 COM: 1.6 YD WEIGHT: 34.0 LB	
	A90		1049 1104 1144 1199 1288 1374 1459												WIDTH: 26.5 DEPTH: 26.0 HEIGHT: 39.0-46.5 SEAT WIDTH: 21.0 SEAT DEPTH: 16.5 SEAT HEIGHT: 16.5-21.0 SEAT HEIGHT W/ SEAT SLIDER: 17.5-22.0 BACK WIDTH: 20.0 BACK HEIGHT: 20.5-23.5 COM: 1.6 YD WEIGHT: 34.0 LB
	SEAT SLIDER (SS) - ADD \$60														
1760	M1	MID-BACK MULTI-FUNCTION	A00	A B/COM C D E F G 834 889 929 984 1073 1159 1244	<ul style="list-style-type: none"> • Ratchet back lumbar adjustment • Infinite back angle adjustment • 6° forward tilt • Center knob tension adjustment • 360° swivel • Pneumatic cylinder height adjustment 	WIDTH: 26.5 DEPTH: 26.0 HEIGHT: 39.0-46.5 SEAT WIDTH: 21.0 SEAT DEPTH: 17.5 SEAT HEIGHT: 18.5-23.0 SEAT HEIGHT W/ SEAT SLIDER: 19.5-24.0 BACK WIDTH: 20.0 BACK HEIGHT: 19.0-22.0 COM: 1.6 YD WEIGHT: 41.0 LB	EP \$60 Edge Protector - a Clear Vinyl Tube Placed Around the Edge of the Back Cushion SS \$60 Seat Slider 2.5" Side Paddle Activated BN1 \$35 Upholstered Outer Back in Black Ballistic Nylon BN2 N/C Upholstered Outer Back in Black Ballistic Nylon HD \$125 Heavy Duty Multi-Shift Upgrade 350 lb. Includes BA2 Aluminum Base and C4 60mm Casters; Available with M1 and Y2 Only	C1 STD Carpet Casters C1S \$35 Hard Floor and Carpet Casters C2S \$35 Decompression Hard Floor and Soft Carpet Caster	BT \$15 Replace Knob with Bolt (For S2 and B2 Controls Only) EF1 \$30 1" Extra Foam on Seat. If EF1 is selected, cannot use MF1 in addition. MF1 \$50 1" Visco Elastic Memory Foam on Seat. If MF1 is selected, cannot use EF1 in addition.						
	A4		934 989 1029 1084 1173 1259 1344	WIDTH: 26.5 DEPTH: 26.0 HEIGHT: 39.0-46.5 SEAT WIDTH: 21.0 SEAT DEPTH: 17.5 SEAT HEIGHT: 18.5-23.0 SEAT HEIGHT W/ SEAT SLIDER: 19.5-24.0 BACK WIDTH: 20.0 BACK HEIGHT: 19.0-22.0 COM: 1.6 YD WEIGHT: 41.0 LB											
	A5		949 1004 1044 1099 1188 1274 1359							<ul style="list-style-type: none"> • Ratchet back lumbar adjustment • Infinite back angle adjustment • Infinite tilt lock • Center knob tension adjustment • 360° swivel • Pneumatic cylinder height adjustment 	WIDTH: 26.5 DEPTH: 26.0 HEIGHT: 39.0-46.5 SEAT WIDTH: 21.0 SEAT DEPTH: 16.5 SEAT HEIGHT: 16.5-21.0 SEAT HEIGHT W/ SEAT SLIDER: 17.5-22.0 BACK WIDTH: 20.0 BACK HEIGHT: 20.5-23.5 COM: 1.6 YD WEIGHT: 34.0 LB				
	A6		994 1049 1089 1144 1233 1319 1404									WIDTH: 26.5 DEPTH: 26.0 HEIGHT: 39.0-46.5 SEAT WIDTH: 21.0 SEAT DEPTH: 16.5 SEAT HEIGHT: 16.5-21.0 SEAT HEIGHT W/ SEAT SLIDER: 17.5-22.0 BACK WIDTH: 20.0 BACK HEIGHT: 20.5-23.5 COM: 1.6 YD WEIGHT: 34.0 LB			
	A7		1009 1064 1104 1159 1248 1334 1419										WIDTH: 26.5 DEPTH: 26.0 HEIGHT: 39.0-46.5 SEAT WIDTH: 21.0 SEAT DEPTH: 16.5 SEAT HEIGHT: 16.5-21.0 SEAT HEIGHT W/ SEAT SLIDER: 17.5-22.0 BACK WIDTH: 20.0 BACK HEIGHT: 20.5-23.5 COM: 1.6 YD WEIGHT: 34.0 LB		
	A16		959 1014 1054 1109 1198 1284 1369											WIDTH: 26.5 DEPTH: 26.0 HEIGHT: 39.0-46.5 SEAT WIDTH: 21.0 SEAT DEPTH: 16.5 SEAT HEIGHT: 16.5-21.0 SEAT HEIGHT W/ SEAT SLIDER: 17.5-22.0 BACK WIDTH: 20.0 BACK HEIGHT: 20.5-23.5 COM: 1.6 YD WEIGHT: 34.0 LB	
	A90		1069 1124 1164 1219 1308 1394 1479												WIDTH: 26.5 DEPTH: 26.0 HEIGHT: 39.0-46.5 SEAT WIDTH: 21.0 SEAT DEPTH: 16.5 SEAT HEIGHT: 16.5-21.0 SEAT HEIGHT W/ SEAT SLIDER: 17.5-22.0 BACK WIDTH: 20.0 BACK HEIGHT: 20.5-23.5 COM: 1.6 YD WEIGHT: 34.0 LB
	SEAT SLIDER (SS) - ADD \$60														

logic

ergonomics, traditional task styling - an unmatched value

GSA SIN # 33721

- Task, stool, conference and executive seating
- Low-, mid- or high-back models
- Ratchet back lumbar height adjustment on select models
- Warranted to 300 lbs.



CREATING LOGIC MODEL NUMBER

MODEL NUMBER CONTROL ARMS GRADE BASE CASTERS PACKAGING OPTIONS

1 7 6 - P 1 - A - B A 1 - C

*FOR ARMLESS USE CODE A00

PACKAGING NOTES

CODE	DESCRIPTION	LIST UPCHARGE
AB	ASSEMBLED IN BAG	\$0
PAC	PARTIALLY ASSEMBLED IN CARTON	\$0
BAC	BACK ASSEMBLED IN CARTON	\$80

MID-BACK STOOLS

MODEL	CONTROL	DESCRIPTION	ARM	FABRIC	FEATURES	DIMENSIONS
1766	P1	MID-BACK 10" STOOL POSTURE BACK Use for work surfaces up to 42" high	A00	A B/COM C D E F G 899 954 994 1049 1138 1224 1309	<ul style="list-style-type: none"> • Ratchet back lumbar adjustment • Height-adjustable 20" diameter foot ring • Infinite back angle adjustment with free float • 360° swivel • Pneumatic cylinder height adjustment 	WIDTH: 26.5 DEPTH: 26.0 HEIGHT: 46.5-59.5 SEAT WIDTH: 21.0 SEAT DEPTH: 17.5 SEAT HEIGHT: 24.5-34.5 BACK WIDTH: 20.0 BACK HEIGHT: 20.5-23.5 COM: 1.6 YD WEIGHT: 43.5 LB
			A4	999 1054 1094 1149 1238 1324 1409		
			A5	1014 1069 1109 1164 1253 1339 1424		
			A6	1059 1114 1154 1209 1298 1384 1469		
			A7	1074 1129 1169 1224 1313 1399 1484		
			A16	1024 1079 1119 1174 1263 1349 1434		
			A90	1134 1189 1229 1284 1373 1459 1544		

SEAT SLIDER (SS) - NOT AVAILABLE

ARM OPTIONS

	A4 \$100		A5 \$115		A6 \$160
	A7 \$175		A16 \$125		A90 \$235

MODEL	CONTROL	DESCRIPTION	ARM	FABRIC	FEATURES	DIMENSIONS
1768	P1	MID-BACK 8" STOOL POSTURE BACK Use for work surfaces up to 36" high	A00	A B/COM C D E F G 899 954 994 1049 1138 1224 1309	<ul style="list-style-type: none"> • Ratchet back lumbar adjustment • Height-adjustable 20" diameter foot ring • Infinite back angle adjustment with free float • 360° swivel • Pneumatic cylinder height adjustment 	WIDTH: 26.5 DEPTH: 26.0 HEIGHT: 43.5-54.5 SEAT WIDTH: 21.0 SEAT DEPTH: 17.5 SEAT HEIGHT: 21.5-29.5 BACK WIDTH: 20.0 BACK HEIGHT: 20.5-23.5 COM: 1.6 YD WEIGHT: 42.5 LB
			A4	999 1054 1094 1149 1238 1324 1409		
			A5	1014 1069 1109 1164 1253 1339 1424		
			A6	1059 1114 1154 1209 1298 1384 1469		
			A7	1074 1129 1169 1224 1313 1399 1484		
			A16	1024 1079 1119 1174 1263 1349 1434		
			A90	1134 1189 1229 1284 1373 1459 1544		

SEAT SLIDER (SS) - NOT AVAILABLE

CASTER OPTIONS

	C1 STD		C1S \$35		C2S \$35
--	------------------	--	--------------------	--	--------------------

ADDITIONAL OPTIONS

	BN1 \$35		BN2 N/C		EP \$60
	EF1 \$30		MF1 \$50		

Upholstered Outer Back in Black Ballistic Nylon
BN1 - with Grade A Only
BN2 - with Grade B and Up

Edge Protector - a Clear Vinyl Tube Placed Around the Edge of the Back Cushion

1" Extra Foam on Seat.
If EF1 is selected, cannot use MF1 in addition.

1" Visco Elastic Memory Foam on Seat. If MF1 is selected, cannot use EF1 in addition.

logic

ergonomics, traditional task styling - an unmatched value

HIGH-BACK

GSA SIN # 33721

- Task, stool, conference and executive seating
- Low-, mid- or high-back models
- Ratchet back lumbar height adjustment on select models
- Heavy duty multi-shift 24/7 optional (350 lb. rating)
- Warranted to 300 lbs.



CREATING LOGIC MODEL NUMBER

MODEL NUMBER CONTROL ARMS GRADE BASE CASTERS PACKAGING OPTIONS

1 7 8 0 - [] [] - A [] [] - [] [] - B A 1 - C [] [] - [] [] - [] []

*FOR ARMLESS USE CODE A00

PACKAGING NOTES

CODE	DESCRIPTION	LIST UPCHARGE
AB	ASSEMBLED IN BAG	\$0
PAC	PARTIALLY ASSEMBLED IN CARTON	\$0
BAC	BACK ASSEMBLED IN CARTON	\$80

MODEL CONTROL DESCRIPTION



HIGH-BACK SWIVEL TILT

ARM	FABRIC	A	B/COM	C	D	E	F	G
A00		792	852	902	962	1052	1142	1252
A4		892	952	1002	1062	1152	1242	1352
A5		907	967	1017	1077	1167	1257	1367
A6		952	1012	1062	1122	1212	1302	1412
A7		967	1027	1077	1137	1227	1317	1427
A16		917	977	1027	1087	1177	1267	1377
A90		1027	1087	1137	1197	1287	1377	1487

SEAT SLIDER (SS) - ADD \$60

FEATURES

- Adjustable back depth
- Upright lock
- Center knob tension adjustment
- 360° swivel
- Pneumatic cylinder height adjustment

DIMENSIONS

WIDTH: 26.5
 DEPTH: 26.0
 HEIGHT: 42.0-49.5
 SEAT WIDTH: 21.0
 SEAT DEPTH: 16.5
 SEAT HEIGHT: 17.0-21.5
 SEAT HEIGHT W/ SEAT SLIDER: 18.0-22.5
 BACK WIDTH: 20.0
 BACK HEIGHT: 24.0-27.0
 COM: 1.8 YD
 WEIGHT: 36.0 LB

ARM OPTIONS

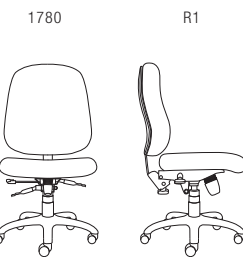
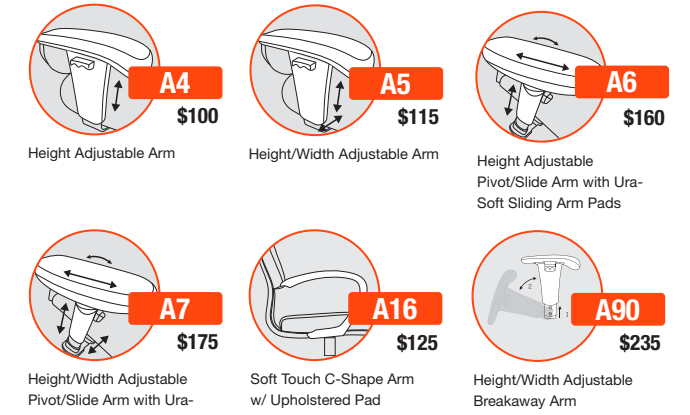

HIGH-BACK ROCKING TILT

ARM	FABRIC	A	B/COM	C	D	E	F	G
A00		842	902	952	1012	1102	1192	1302
A4		942	1002	1052	1112	1202	1292	1402
A5		957	1017	1067	1127	1217	1307	1417
A6		1002	1062	1112	1172	1262	1352	1462
A7		1017	1077	1127	1187	1277	1367	1477
A16		967	1027	1077	1137	1227	1317	1427
A90		1077	1137	1187	1247	1337	1427	1537

SEAT SLIDER (SS) - ADD \$60

- Ratchet back lumbar adjustment
- Infinite back angle adjustment
- Infinite tilt lock
- Center knob tension adjustment
- 360° swivel
- Pneumatic cylinder height adjustment

WIDTH: 26.5
 DEPTH: 26.0
 HEIGHT: 42.0-49.5
 SEAT WIDTH: 21.0
 SEAT DEPTH: 16.5
 SEAT HEIGHT: 17.0-21.5
 SEAT HEIGHT W/ SEAT SLIDER: 18.0-22.5
 BACK WIDTH: 20.0
 BACK HEIGHT: 24.0-27.0
 COM: 1.8 YD
 WEIGHT: 41.0 LB

CASTER OPTIONS

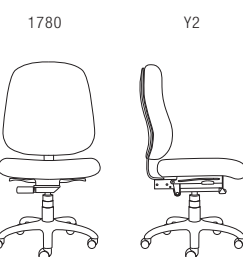

HIGH-BACK HEAVY DUTY SYNCHRO TILT

ARM	FABRIC	A	B/COM	C	D	E	F	G
A00		872	932	982	1042	1132	1222	1332
A4		972	1032	1082	1142	1232	1322	1432
A5		987	1047	1097	1157	1247	1337	1447
A6		1032	1092	1142	1202	1292	1382	1492
A7		1047	1107	1157	1217	1307	1397	1507
A16		997	1057	1107	1167	1257	1347	1457
A90		1107	1167	1217	1277	1367	1457	1567

SEAT SLIDER (SS) - ADD \$60

- Ratchet back lumbar adjustment
- 4-position tilt lock
- Side knob tension adjustment
- 2:1 back-to-seat tilt ratio
- 360° swivel
- Pneumatic cylinder height adjustment

WIDTH: 26.5
 DEPTH: 26.0
 HEIGHT: 40.5-48.0
 SEAT WIDTH: 21.0
 SEAT DEPTH: 17.5
 SEAT HEIGHT: 17.0-21.5
 SEAT HEIGHT W/ SEAT SLIDER: 18.0-22.5
 BACK WIDTH: 20.0
 BACK HEIGHT: 24.0-27.0
 COM: 1.8 YD
 WEIGHT: 43.0 LB

ADDITIONAL OPTIONS

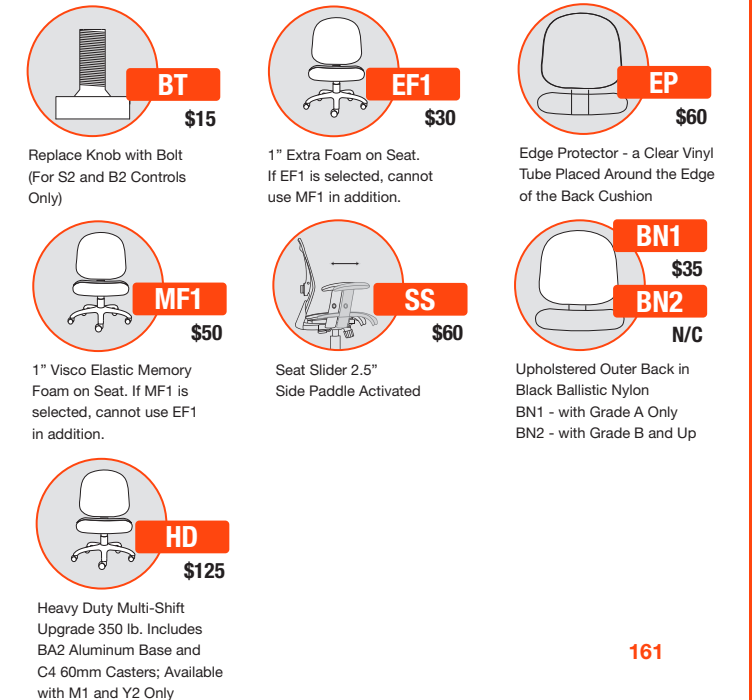

logic plus

ergonomics, traditional task styling - an unmatched value

GSA SIN # 33721

- Task seating
- Heavy duty multi-function control, base and pneumatic cylinder
- Ratchet back lumbar height adjustment
- Seat slider standard
- Warranted to 500 lbs.



HIGH-BACK

CREATING LOGIC PLUS MODEL NUMBER



PACKAGING NOTES

CODE	DESCRIPTION	LIST UPCHARGE
AB	ASSEMBLED IN BAG	\$0
BAC	BACK ASSEMBLED IN CARTON	\$80

MODEL	CONTROL	DESCRIPTION	ARM	FABRIC/LEATHER	FEATURES	DIMENSIONS																																										
1790	M2	HIGH-BACK HEAVY DUTY MULTI-FUNCTION	A00	<table border="1"> <thead> <tr> <th>A</th> <th>B/COM</th> <th>C</th> <th>D</th> <th>E</th> <th>F</th> <th>G</th> </tr> </thead> <tbody> <tr> <td>1296</td> <td>1406</td> <td>1476</td> <td>1576</td> <td>1736</td> <td>1876</td> <td>2036</td> </tr> <tr> <td>1411</td> <td>1521</td> <td>1591</td> <td>1691</td> <td>1851</td> <td>1991</td> <td>2151</td> </tr> <tr> <td>1421</td> <td>1531</td> <td>1601</td> <td>1701</td> <td>1861</td> <td>2001</td> <td>2161</td> </tr> <tr> <td>1436</td> <td>1546</td> <td>1616</td> <td>1716</td> <td>1876</td> <td>2016</td> <td>2176</td> </tr> <tr> <td>1531</td> <td>1641</td> <td>1711</td> <td>1811</td> <td>1971</td> <td>2111</td> <td>2271</td> </tr> </tbody> </table>	A	B/COM	C	D	E	F	G	1296	1406	1476	1576	1736	1876	2036	1411	1521	1591	1691	1851	1991	2151	1421	1531	1601	1701	1861	2001	2161	1436	1546	1616	1716	1876	2016	2176	1531	1641	1711	1811	1971	2111	2271	<ul style="list-style-type: none"> • Weight capacity up to 500 lbs. • Infinite back angle adjustment • 6° forward tilt • Side knob tension adjustment • 360° swivel • Pneumatic cylinder height adjustment 	WIDTH: 30.0-33.0 DEPTH: 28.0 HEIGHT: 43.5-52.0 SEAT WIDTH: 25.0 SEAT DEPTH: 17.0-20.0 SEAT HEIGHT: 17.0-22.0 BACK WIDTH: 23.5 BACK HEIGHT: 26.5-30.5 COM: 3.1 YD WEIGHT: 65.0 LB
A	B/COM		C	D	E	F	G																																									
1296	1406		1476	1576	1736	1876	2036																																									
1411	1521		1591	1691	1851	1991	2151																																									
1421	1531		1601	1701	1861	2001	2161																																									
1436	1546		1616	1716	1876	2016	2176																																									
1531	1641	1711	1811	1971	2111	2271																																										
		A5																																														
		A36																																														
		A37																																														
		A90																																														

SEAT SLIDER (SS) - STANDARD

ARM OPTIONS



Height/Width Adjustable Arm



Height/Width Adjustable Breakaway Arm



Height Adjustable Pivot/Slide Arm



Height/Width Adjustable Pivot/Slide Arm

BASE OPTIONS



26" Heavy Duty Nylon Base - Black

CASTER OPTIONS



Heavy Duty Hard Wood Floor and Carpet Casters



Hard Floor and Carpet Casters



Decompression Hard Floor and Soft Carpet Casters

ADDITIONAL OPTIONS

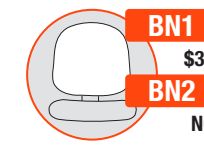

Upholstered Outer Back in Black Ballistic Nylon
BN1 - with Grade A Only
BN2 - with Grade B and Up

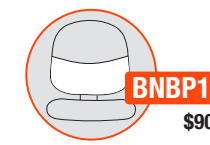

Ballistic Nylon Applied Over a Portion of the Lower Backrest Surface

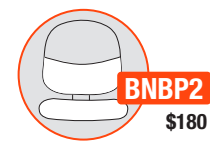

Ballistic Nylon Applied Over a Portion of the Lower Backrest Surface and Full Seat

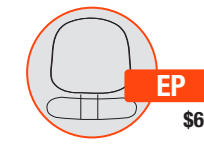

Edge Protector - a Clear Vinyl Tube Placed Around the Edge of the Back Cushion

luna

high design meets supreme ergonomics

GSA SIN # 33721

- Task, stool, conference, executive, side and guest seating
- Seat slider standard
- Polished aluminum accents
- Height-adjustable lumbar optional
- Warranted to 300 lbs.



CREATING LUNA MODEL NUMBER

MODEL NUMBER CONTROL ARMS PLASTIC COLOR MESH COLOR GRADE BASE CASTERS PACKAGING OPTIONS

3 4 6 0 - A 4 - P - M - B A - C

* FOR ARMLESS USE CODE A00

PACKAGING NOTES

CODE	DESCRIPTION	LIST UPCHARGE
AB	ASSEMBLED IN BAG	\$0
PAC	PARTIALLY ASSEMBLED IN CARTON	\$0
BAC	BACK ASSEMBLED IN CARTON	\$80

MESH BACK TASK

MODEL CONTROL DESCRIPTION

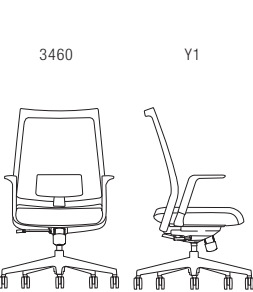

SIMPLE SYNCHRO TILT

ARM	FABRIC/LEATHER	A	B/COM	C	D	E	F	G	L3/COL	L4	L5
A00		754	784	814	874	929	969	1029	929	944	1084
A43B/D		829	859	889	949	1004	1044	1104	1004	1019	1159
A45B/D		844	874	904	964	1019	1059	1119	1019	1034	1174

FEATURES DIMENSIONS

- Seat slider standard
- Upright tilt lock
- 3:1 back-to-seat tilt ratio
- Center knob tension adjustment
- 360° swivel
- Pneumatic cylinder height adjustment

WIDTH: 27.0
 DEPTH: 27.0
 HEIGHT: 39.5-44.0
 SEAT WIDTH: 20.0
 SEAT DEPTH: 16.0-18.5
 SEAT HEIGHT: 16.0-20.5
 BACK WIDTH: 21.5
 BACK HEIGHT: 23.5
 COM: 0.9 YD
 COL: 13 SQ FT
 WEIGHT: 41.0 LB

ARM OPTIONS



Fixed Arm
 A43B - Black
 A43D - Dove Gray
\$75



4-Way Height and Width Adjustable Arm
 A45B - Black
 A45D - Dove Gray
\$90

CASTER OPTIONS



Large Diameter Carpet Casters
C6 STD



Large Diameter Hard Floor and Carpet Casters
C6S \$35



Chrome-Accented Hard Floor and Carpet Casters
C7 \$35



Hubless Hard Floor and Carpet Casters
C22B \$30



Hubless Hard Floor and Carpet Casters
C22G \$30

BASE OPTIONS



27" Mid-Profile Nylon Base
 BA11B - Black
 BA11D - Graphite
STD



27" Mid-Profile Aluminum Base - Polished
\$110

ADDITIONAL OPTIONS

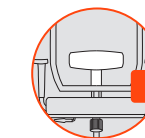

Height Adjustable Lumbar
LB* \$30



Heavy Duty Multi-Shift Upgrade 350 lb. Includes BA12P High Profile Aluminum Base (Y3 control only)
HD \$125



Stationary Base Glide
G1 \$30

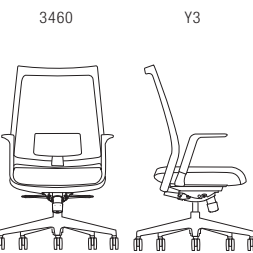

FULL SYNCHRO TILT

ARM	FABRIC/LEATHER	A	B/COM	C	D	E	F	G	L3/COL	L4	L5
A00		794	824	854	914	969	1009	1069	969	984	1124
A43B/D		869	899	929	989	1044	1084	1144	1044	1059	1199
A45B/D		884	914	944	1004	1059	1099	1159	1059	1074	1214

- Seat slider standard
- 3-position tilt lock
- 2:1 back-to-seat tilt ratio
- Center knob tension adjustment
- 360° swivel
- Pneumatic cylinder height adjustment

WIDTH: 27.0
 DEPTH: 27.0
 HEIGHT: 41.0-45.5
 SEAT WIDTH: 20.0
 SEAT DEPTH: 16.5-19.5
 SEAT HEIGHT: 16-20.5
 BACK WIDTH: 21.5
 BACK HEIGHT: 24.0
 COM: 0.9 YD
 COL: 13 SQ FT
 WEIGHT: 43.0 LB

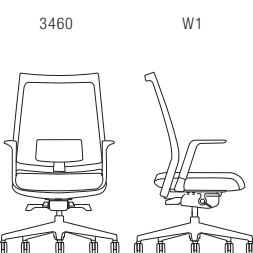

WEIGHT-BALANCED SYNCHRO TILT

ARM	FABRIC/LEATHER	A	B/COM	C	D	E	F	G	L3/COL	L4	L5
A00		809	839	869	929	984	1024	1084	984	999	1139
A43B/D		884	914	944	1004	1059	1099	1159	1059	1074	1214
A45B/D		899	929	959	1019	1074	1114	1174	1074	1089	1229

- Seat slider standard
- Automatic tension adjustment
- 2-position tilt lock
- 3:1 back-to-seat tilt ratio
- 360° swivel
- Pneumatic cylinder height adjustment

WIDTH: 27.0
 DEPTH: 27.0
 HEIGHT: 40.0-44.5
 SEAT WIDTH: 20.0
 SEAT DEPTH: 16.5-19.5
 SEAT HEIGHT: 16.0-20.5
 BACK WIDTH: 21.5
 BACK HEIGHT: 24.0
 COM: 0.9 YD
 COL: 13 SQ FT
 WEIGHT: 41.0 LB

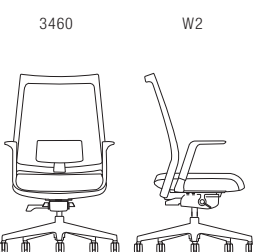

ADVANCED WEIGHT-BALANCED SYNCHRO TILT

ARM	FABRIC/LEATHER	A	B/COM	C	D	E	F	G	L3/COL	L4	L5
A00		839	869	899	959	1014	1054	1114	1014	1029	1169
A43B/D		914	944	974	1034	1089	1129	1189	1089	1104	1244
A45B/D		929	959	989	1049	1104	1144	1204	1104	1119	1259

- Seat slider standard
- Automatic tension adjustment with option to modify
- 4-position tilt lock
- 3:1 back-to-seat tilt ratio
- 360° swivel
- Pneumatic cylinder height adjustment

WIDTH: 27.0
 DEPTH: 27.0
 HEIGHT: 40.0-44.5
 SEAT WIDTH: 20.0
 SEAT DEPTH: 16.5-18.5
 SEAT HEIGHT: 16.5-21.0
 BACK WIDTH: 21.5
 BACK HEIGHT: 24.0
 COM: 0.9 YD
 COL: 13 SQ FT
 WEIGHT: 41.0 LB

MESH COLORS

M2	BLACK M21*	GRAY M22*	WHITE M23	GREEN M24
M2	RED M25	BLUE M26	ORANGE M27	AQUA M28

M4	LATTE M40	CLOUD M41	LEMON M42	APPLE M43	TANGERINE M44	CRIMSON M46
M4	ONYX M48	DOVE M49	AZURE M50	FEDERAL BLUE M51	WHITE WHISPER M52	

PLASTIC COLORS

BLACK PBK	DOVE GRAY PDG
-----------	---------------

BLACK NC

DOVE GRAY \$35

*When selecting M21 & M22 mesh, a lumbar (LB) will be included at no charge

luna

high design meets supreme ergonomics

GSA SIN # 33721

- Task, stool, conference, executive, side and guest seating
- Polished aluminum accents
- Height-adjustable lumbar optional
- Warranted to 300 lbs.



CREATING LUNA MODEL NUMBER

MODEL NUMBER CONTROL ARMS PLASTIC COLOR MESH COLOR GRADE BASE CASTERS PACKAGING OPTIONS

3 4 6 - Y 1 - A 4 - P - M - B A 1 - C

* FOR ARMLESS USE CODE A00

PACKAGING NOTES

CODE	DESCRIPTION	LIST UPCHARGE
AB	ASSEMBLED IN BAG	\$0
PAC	PARTIALLY ASSEMBLED IN CARTON	\$0
BAC	BACK ASSEMBLED IN CARTON	\$80

MESH BACK STOOLS

MODEL	CONTROL	DESCRIPTION	ARM	FABRIC/LEATHER	FEATURES	DIMENSIONS																																								
3466	Y1	10" STOOL SIMPLE SYNCHRO TILT Use for work surfaces up to 42"	A00	<table border="1"> <thead> <tr> <th>A</th> <th>B/COM</th> <th>C</th> <th>D</th> <th>E</th> <th>F</th> <th>G</th> <th>L3/COL</th> <th>L4</th> <th>L5</th> </tr> </thead> <tbody> <tr> <td>879</td> <td>909</td> <td>939</td> <td>999</td> <td>1054</td> <td>1094</td> <td>1154</td> <td>1054</td> <td>1069</td> <td>1209</td> </tr> <tr> <td>954</td> <td>984</td> <td>1014</td> <td>1074</td> <td>1129</td> <td>1169</td> <td>1229</td> <td>1129</td> <td>1144</td> <td>1284</td> </tr> <tr> <td>969</td> <td>999</td> <td>1029</td> <td>1089</td> <td>1144</td> <td>1184</td> <td>1244</td> <td>1144</td> <td>1159</td> <td>1299</td> </tr> </tbody> </table>	A	B/COM	C	D	E	F	G	L3/COL	L4	L5	879	909	939	999	1054	1094	1154	1054	1069	1209	954	984	1014	1074	1129	1169	1229	1129	1144	1284	969	999	1029	1089	1144	1184	1244	1144	1159	1299	<ul style="list-style-type: none"> • Height-adjustable 20" diameter foot ring • Upright tilt lock • 3:1 back-to-seat tilt ratio • Center knob tension control • 360° swivel • Pneumatic cylinder height adjustment 	WIDTH: 27.0 DEPTH: 27.0 HEIGHT: 50.0-60.0 SEAT WIDTH: 20.0 SEAT DEPTH: 16.0-19.0 SEAT HEIGHT: 26.0-36.0 BACK WIDTH: 21.0 BACK HEIGHT: 24.0 COM: 0.9 YD COL: 13 SQ FT WEIGHT: 47.0 LB
A	B/COM		C	D	E	F	G	L3/COL	L4	L5																																				
879	909		939	999	1054	1094	1154	1054	1069	1209																																				
954	984	1014	1074	1129	1169	1229	1129	1144	1284																																					
969	999	1029	1089	1144	1184	1244	1144	1159	1299																																					
		A43B/D																																												
		A45B/D																																												
3468	Y1	8" STOOL SIMPLE SYNCHRO TILT Use for work surfaces up to 36"	A00	<table border="1"> <thead> <tr> <th>A</th> <th>B/COM</th> <th>C</th> <th>D</th> <th>E</th> <th>F</th> <th>G</th> <th>L3/COL</th> <th>L4</th> <th>L5</th> </tr> </thead> <tbody> <tr> <td>879</td> <td>909</td> <td>939</td> <td>999</td> <td>1054</td> <td>1094</td> <td>1154</td> <td>1054</td> <td>1069</td> <td>1209</td> </tr> <tr> <td>954</td> <td>984</td> <td>1014</td> <td>1074</td> <td>1129</td> <td>1169</td> <td>1229</td> <td>1129</td> <td>1144</td> <td>1284</td> </tr> <tr> <td>969</td> <td>999</td> <td>1029</td> <td>1089</td> <td>1144</td> <td>1184</td> <td>1244</td> <td>1144</td> <td>1159</td> <td>1299</td> </tr> </tbody> </table>	A	B/COM	C	D	E	F	G	L3/COL	L4	L5	879	909	939	999	1054	1094	1154	1054	1069	1209	954	984	1014	1074	1129	1169	1229	1129	1144	1284	969	999	1029	1089	1144	1184	1244	1144	1159	1299	<ul style="list-style-type: none"> • Height-adjustable 20" diameter foot ring • Upright tilt lock • 3:1 back-to-seat tilt ratio • Center knob tension control • 360° swivel • Pneumatic cylinder height adjustment 	WIDTH: 27.0 DEPTH: 27.0 HEIGHT: 45.0-53.0 SEAT WIDTH: 20.0 SEAT DEPTH: 16.0-19.0 SEAT HEIGHT: 22.0-30.0 BACK WIDTH: 21.0 BACK HEIGHT: 24.0 COM: 0.9 YD COL: 13 SQ FT WEIGHT: 46.0 LB
A	B/COM		C	D	E	F	G	L3/COL	L4	L5																																				
879	909		939	999	1054	1094	1154	1054	1069	1209																																				
954	984	1014	1074	1129	1169	1229	1129	1144	1284																																					
969	999	1029	1089	1144	1184	1244	1144	1159	1299																																					
		A43B/D																																												
		A45B/D																																												

ARM OPTIONS



A43B/D
\$75

Fixed Arm
A43B - Black
A43D - Dove Gray



A45B/D
\$90

4-Way Height and Width Adjustable Arm
A45B - Black
A45D - Dove Gray

BASE OPTIONS



BA11B/G
STD

27" Mid-Profile Nylon Base
BA11B - Black
BA11D - Graphite



BA12P
\$110

27" Mid-Profile Aluminum Base - Polished

ADDITIONAL OPTIONS

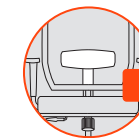

LB
\$30

Height Adjustable Lumbar



G1
\$30

Stationary Base Glide

CASTER OPTIONS



C6
STD

Large Diameter Carpet Casters



C6S
\$35

Large Diameter Hard Floor and Carpet Casters



C7
\$35

Chrome-Accented Hard Floor and Carpet Casters



C22B
\$30

Hubless Hard Floor and Carpet Casters



C22G
\$30

Hubless Hard Floor and Carpet Casters

MESH COLORS

M2	BLACK M21	GRAY M22	WHITE M23	GREEN M24
M2	RED M25	BLUE M26	ORANGE M27	AQUA M28

M4	LATTE M40	CLOUD M41	LEMON M42	APPLE M43	TANGERINE M44	CRIMSON M46
M4	ONYX M48	DOVE M49	AZURE M50	FEDERAL BLUE M51	WHITE WHISPER M52	

PLASTIC COLORS

BLACK PBK	DOVE GRAY PDG
--------------	---------------------

BLACK

NC

DOVE GRAY

\$35

mila

elegant, intuitive and versatile

GSA SIN # 33721

- Conference and executive seating
- Weight-balanced control
- Sculpted aluminum frame
- Mesh or upholstered back
- Warranted to 300 lbs.



CREATING MILA MODEL NUMBER

MODEL NUMBER	CONTROL	ARMS	FRAME COLOR	UPHOLSTERY	MESH/KNIT COLOR	GRADE	BASE	CASTERS	PACKAGING
3760	Z1	A47	F	B			BA12	C	

PACKAGING NOTES

CODE	DESCRIPTION	LIST UPCHARGE
AB	ASSEMBLED IN BAG	\$0
BAC	BACK ASSEMBLED IN CARTON	\$0

MESH BACK (MB) & UPHOLSTERED BACK (UB)

MODEL	CONTROL	DESCRIPTION	ARM	FABRIC/LEATHER											FEATURES	DIMENSIONS
				A	B/COM	C	D	E	F	G	L3/COL	L4	L5			
3760	Z1	MESH BACK - MB SIMPLE WEIGHT-BALANCED	A47	1444	1479	1504	1559	1594	1634	1684	1639	1744	1894	<ul style="list-style-type: none"> • Urethane covered back frame • Automatic tension adjustment • 12° recline or upright tilt lock • 360° swivel • Pneumatic cylinder height adjustment 	WIDTH: 27.5 DEPTH: 27.0 HEIGHT: 40.5-45.0 SEAT WIDTH: 20.0 SEAT DEPTH: 18.0 SEAT HEIGHT: 17.0-21.5 BACK WIDTH: 20.5 BACK HEIGHT: 23.5 COM: 1.0 YD COL: 11.0 SQ FT WEIGHT: 36.5 LB	
3760	Z1	UPHOLSTERED BACK - UB SIMPLE WEIGHT-BALANCED	A47	1510	1560	1590	1640	1695	1750	1815	1705	1810	2260	<ul style="list-style-type: none"> • Slim molded foam upholstered back • Automatic tension adjustment • 12° recline or upright tilt lock • 360° swivel • Pneumatic cylinder height adjustment 	WIDTH: 27.5 DEPTH: 27.0 HEIGHT: 40.5-45.0 SEAT WIDTH: 20.0 SEAT DEPTH: 18.0 SEAT HEIGHT: 17.0-21.5 BACK WIDTH: 20.3 BACK HEIGHT: 23.5 COM: 1.8 YD COL: 33.0 SQ FT WEIGHT: 36.5 LB	

ARM OPTIONS



Fixed Aluminum Arm with Soft Urethane Pad

BASE OPTIONS



27" Mid-Profile Aluminum Base
 BA12B - Black
 BA12P - Polished
 BA12S - Silver
 (C7 Chrome-Accented Casters Standard with Polished Base)

FRAME COLORS

BLACK BF	POLISHED PF
-------------	----------------

MESH COLORS

M2	BLACK M21	GRAY M22	WHITE M23	GREEN M24	M1 MESH NC
M2	RED M25	BLUE M26	ORANGE M27	AQUA M28	

M4	LATTE M40	CLOUD M41	LEMON M42	APPLE M43	TANGERINE M44	CRIMSON M46	M4 MESH NC
M4	ONYX M48	DOVE M49	AZURE M50	FEDERAL BLUE M51	WHITE WHISPER M52		

KNIT BACK COLORS

KB	BLACK K01	CHARCOAL GRAY K02	MISTY GRAY K03	KB \$25
----	--------------	-------------------------	----------------------	------------

CASTER OPTIONS



Large Diameter Carpet Casters (Standard with silver powder coat base)



Large Diameter Hard Floor and Carpet Casters



Chrome-Accented Hard Floor and Carpet Casters (Standard with Polished Base)

neo

the new way to work

GSA SIN # 33721

- Task, stool, conference and executive seating
- Integrated height-adjustable lumbar
- Seat slider standard
- Warranted to 300 lbs.



CREATING NEO MODEL NUMBER

MODEL NUMBER CONTROL PLASTIC COLOR MESH COLOR ARMS GRADE BASE NUMBER CASTERS PACKAGING

3 1 6 - - P - M - A - - B A - C - - -

PACKAGING NOTES

CODE	DESCRIPTION	LIST UPCHARGE
AB	ASSEMBLED IN BAG	\$0
PAC	PARTIALLY ASSEMBLED IN CARTON	\$0
BAC	BACK ASSEMBLED IN CARTON	\$80

MESH BACK TASK AND STOOLS

MODEL	CONTROL	DESCRIPTION	ARM	FABRIC/LEATHER	FEATURES	DIMENSIONS	ARM OPTIONS	CASTER OPTIONS
3160	Y1	SIMPLE SYNCHRO TILT	A00	A B/COM C D E F G L3/COL L4 L5 603 633 663 723 778 818 878 778 803 953	<ul style="list-style-type: none"> • Upright tilt lock • 3:1 back-to-seat tilt ratio • Center knob tension adjustment • 360° swivel • Pneumatic cylinder height adjustment 	WIDTH: 25.5 DEPTH: 25.5 HEIGHT: 37.0-41.5 SEAT WIDTH: 19.5 SEAT DEPTH: 17.5-20.0 SEAT HEIGHT: 17.0-21.5 BACK WIDTH: 17.5 BACK HEIGHT: 21.0 COM: 1.1 YD COL: 13.0 SQ FT WEIGHT: 35.0 LB	A23B/G/W \$95 6-Way Height Adjustable Arm A23B - Black A23G - Graphite Gray A23W - White	A46B/G/W \$75 Nylon Loop Arm A46B - Black A46G - Graphite Gray A46W - White
			A23B/G/W	698 728 758 818 873 913 973 873 898 1048				
			A46B/G/W	678 708 738 798 853 893 953 853 878 1028				
			A36	728 758 788 848 903 943 1003 903 928 1078				
			A37	743 773 803 863 918 958 1018 918 943 1093				
3160	Y3	FULL SYNCHRO TILT	A00	A B/COM C D E F G L3/COL L4 L5 643 673 703 763 818 858 918 818 843 993	<ul style="list-style-type: none"> • 3-position tilt lock • 2:1 back-to-seat tilt ratio • Center knob tension adjustment • 360° swivel • Pneumatic cylinder height adjustment 	WIDTH: 25.5 DEPTH: 25.5 HEIGHT: 37.0-41.5 SEAT WIDTH: 19.5 SEAT DEPTH: 17.5-20.0 SEAT HEIGHT: 17.0-21.5 BACK WIDTH: 17.5 BACK HEIGHT: 21.0 COM: 1.1 YD COL: 13.0 SQ FT WEIGHT: 35.0 LB	A36 \$125 Height Adjustable Pivot/Slide Arm	A37 \$140 Height/Width Adjustable Pivot/Slide Arm
			A23B/G/W	738 768 798 858 913 953 1013 913 938 1088				
			A46B/G/W	718 748 778 838 893 933 993 893 918 1068				
			A36	768 798 828 888 943 983 1043 943 968 1118				
			A37	783 813 843 903 958 998 1058 958 983 1133				
3160	W1	WEIGHT-BALANCED SYNCHRO TILT	A00	A B/COM C D E F G L3/COL L4 L5 658 688 718 778 833 873 933 833 858 1008	<ul style="list-style-type: none"> • Automatic tension adjustment • 2-position tilt lock • 3:1 back-to-seat tilt ratio • 360° swivel • Pneumatic cylinder height adjustment 	WIDTH: 25.5 DEPTH: 25.5 HEIGHT: 37.0-41.5 SEAT WIDTH: 19.5 SEAT DEPTH: 17.5-20.0 SEAT HEIGHT: 17.0-22.0 BACK WIDTH: 17.5 BACK HEIGHT: 21.0 COM: 1.1 YD COL: 13.0 SQ FT WEIGHT: 35.0 LB	BA12P \$110 26" High Profile Aluminum Base BA12P - Polished	BA11B/G/W STD 27" Mid-Profile Nylon Base BA11B - Black BA11D - Graphite BA11W - White
			A23B/G/W	753 783 813 873 928 968 1028 928 953 1103				
			A46B/G/W	733 763 793 853 908 948 1008 908 933 1083				
			A36	783 813 843 903 958 998 1058 958 983 1133				
			A37	798 828 858 918 973 1013 1073 973 998 1148				
3166	Y1	10" STOOL SIMPLE SYNCHRO TILT	A00	A B/COM C D E F G L3/COL L4 L5 728 758 788 848 903 943 1003 903 928 1078	<ul style="list-style-type: none"> • Height-adjustable 20" diameter foot ring • Upright tilt lock • 3:1 back-to-seat tilt ratio • Center knob tension control • 360° swivel • Pneumatic cylinder height adjustment 	WIDTH: 25.5 DEPTH: 25.5 HEIGHT: 47.5-57.5 SEAT WIDTH: 19.5 SEAT DEPTH: 17.5-20.0 SEAT HEIGHT: 27.0-37.0 BACK WIDTH: 17.5 BACK HEIGHT: 21.0 COM: 1.1 YD COL: 13.0 SQ FT WEIGHT: 41.0 LB	G1 \$30 Stationary Base Glide	C6 STD Large Diameter Carpet Casters
			A23B/G/W	823 853 883 943 998 1038 1098 998 1023 1173				
			A46B/G/W	803 833 863 923 978 1018 1078 978 1003 1153				
			A36	853 883 913 973 1028 1068 1128 1028 1053 1203				
			A37	868 898 928 988 1043 1083 1143 1043 1068 1218				
3168	Y1	8" STOOL SIMPLE SYNCHRO TILT	A00	A B/COM C D E F G L3/COL L4 L5 728 758 788 848 903 943 1003 903 928 1078	<ul style="list-style-type: none"> • Height-adjustable 20" diameter foot ring • Upright tilt lock • 3:1 back-to-seat tilt ratio • Center knob tension control • 360° swivel • Pneumatic cylinder height adjustment 	WIDTH: 25.5 DEPTH: 25.5 HEIGHT: 34.0-42.0 SEAT WIDTH: 19.5 SEAT DEPTH: 17.5-20.0 SEAT HEIGHT: 23.0-31.0 BACK WIDTH: 17.5 BACK HEIGHT: 21.0 COM: 1.1 YD COL: 13.0 SQ FT WEIGHT: 40.0 LB		C6S \$35 Large Diameter Hard Floor and Carpet Casters
			A23B/G/W	823 853 883 943 998 1038 1098 998 1023 1173				
			A46B/G/W	803 833 863 923 978 1018 1078 978 1003 1153				
			A36	853 883 913 973 1028 1068 1128 1028 1053 1203				
			A37	868 898 928 988 1043 1083 1143 1043 1068 1218				

PLASTIC AND MESH COLORS

M3	BLACK	GRAPHITE	WHITE
	BLACK PBK	GRAPHITE MESH M31	WHITE PWH
		GRAPHITE GRAY PGG	SNOW MESH M33
		SLATE MESH M32	
	BLACK NC	GRAPHITE \$35	WHITE \$35
M4	LATTE M40	CLOUD M41	LEMON M42
	APPLE M43	TANGERINE M44	CRIMSON M46
	ONYX M48	DOVE M49	AZURE M50
	FEDERAL BLUE M51	WHITE WHISPER M52	
	M4 MESH \$25		

neo lite

equal parts of design, comfort and value

GSA SIN # 33721

- Task, stool, conference and executive seating
- Integrated height-adjustable lumbar standard
- Warranted to 300 lbs.



CREATING NEO LITE MODEL NUMBER

MODEL NUMBER	CONTROL	PLASTIC COLOR	MESH COLOR	ARMS	GRADE	BASE NUMBER	CASTERS	PACKAGING
315		P	M3	A		BA	C	

PACKAGING NOTES

CODE	DESCRIPTION	LIST UPCHARGE
AB	ASSEMBLED IN BAG	\$0
PAC	PARTIALLY ASSEMBLED IN CARTON	\$0
BAC	BACK ASSEMBLED IN CARTON	\$80

MESH BACK AND STOOLS

MODEL CONTROL DESCRIPTION

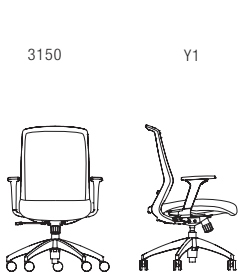

SIMPLE SYNCHRO TILT

ARM	FABRIC/LEATHER	A	B/COM	C	D	E	F	G	L3/COL	L4	L5
A00		538	568	598	658	713	753	813	713	738	888
A23B/G/W		633	663	693	753	808	848	908	808	833	983
A46B/G/W		613	643	673	733	788	828	888	788	813	963
A36		663	693	723	783	838	878	938	838	863	1013
A37		678	708	738	798	853	893	953	853	878	1028

FEATURES

- Upright tilt lock
- 3:1 back-to-seat tilt ratio
- Center knob tension adjustment
- 360° swivel
- Pneumatic cylinder height adjustment

DIMENSIONS

WIDTH:	25.0
DEPTH:	26.0
HEIGHT:	38.0-42.5
SEAT WIDTH:	19.5
SEAT DEPTH:	18.5
SEAT HEIGHT:	18.0-22.5
BACK WIDTH:	17.5
BACK HEIGHT:	21.5
COM:	.9 YD
COL:	11.0 LB
WEIGHT:	34.0 LB

ARM OPTIONS



A23B/G/W
\$95

6-Way Height Adjustable Arm
A23B - Black
A23G - Graphite Gray
A23W - White



A46B/G/W
\$75

Nylon Loop Arm
A46B - Black
A46G - Graphite Gray
A46W - White

CASTER OPTIONS



C6
STD

Large Diameter Carpet Casters



C6S
\$35

Large Diameter Hard Floor and Carpet Casters



C7
\$35

Chrome-Accented Hard Floor and Carpet Casters

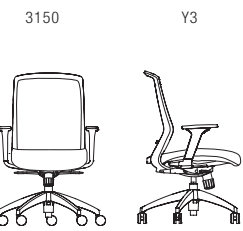

FULL SYNCHRO TILT

ARM	FABRIC/LEATHER	A	B/COM	C	D	E	F	G	L3/COL	L4	L5
A00		578	608	638	698	753	793	853	753	778	928
A23B/G/W		673	703	733	793	848	888	948	848	873	1023
A46B/G/W		653	683	713	773	828	868	928	828	853	1003
A36		703	733	763	823	878	918	978	878	903	1053
A37		718	748	778	838	893	933	993	893	918	1068

- 3-position tilt lock
- 2:1 back-to-seat tilt ratio
- Center knob tension adjustment
- 360° swivel
- Pneumatic cylinder height adjustment

WIDTH:	25.0
DEPTH:	26.0
HEIGHT:	38.0-42.5
SEAT WIDTH:	19.5
SEAT DEPTH:	18.5
SEAT HEIGHT:	18.0-22.5
BACK WIDTH:	17.5
BACK HEIGHT:	21.5
COM:	.9 YD
COL:	11.0 LB
WEIGHT:	34.0 LB

BASE OPTIONS



BA12P
\$110

26" High Profile Aluminum Base
BA12P - Polished



BA11B/G/W
STD

27" Mid-Profile Nylon Base
BA11B - Black
BA11D - Graphite
BA11W - White



G1
\$30

Stationary Base Glide

PLASTIC AND MESH COLORS

BLACK PBK	GRAPHITE MESH M31	GRAPHITE GRAY PGG	SLATE MESH M32	WHITE PWH	SNOW MESH M33
BLACK NC		GRAPHITE \$35		WHITE \$35	



10" STOOL SIMPLE SYNCHRO TILT

Use for work surfaces up to 42"

ARM	FABRIC/LEATHER	A	B/COM	C	D	E	F	G	L3/COL	L4	L5
A00		663	693	723	783	838	878	938	838	863	1013
A23B/G/W		758	788	818	878	933	973	1033	933	958	1108
A46B/G/W		738	768	798	858	913	953	1013	913	938	1088
A36		788	818	848	908	963	1003	1063	963	988	1138
A37		803	833	863	923	978	1018	1078	978	1003	1153

- Height-adjustable 20" diameter foot ring
- Upright tilt lock
- 3:1 back-to-seat tilt ratio
- Center knob tension control
- 360° swivel
- Pneumatic cylinder height adjustment

WIDTH:	25.0
DEPTH:	26.0
HEIGHT:	47.5-57.5
SEAT WIDTH:	19.5
SEAT DEPTH:	18.5
SEAT HEIGHT:	27.5-37.5
BACK WIDTH:	17.5
BACK HEIGHT:	21.5
COM:	.9 YD
COL:	11.0 LB
WEIGHT:	40.0 LB

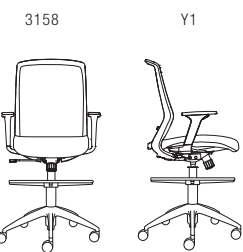

8" STOOL SIMPLE SYNCHRO TILT

Use for work surfaces up to 36"

ARM	FABRIC/LEATHER	A	B/COM	C	D	E	F	G	L3/COL	L4	L5
A00		663	693	723	783	838	878	938	838	863	1013
A23B/G/W		758	788	818	878	933	973	1033	933	958	1108
A46B/G/W		738	768	798	858	913	953	1013	913	938	1088
A36		788	818	848	908	963	1003	1063	963	988	1138
A37		803	833	863	923	978	1018	1078	978	1003	1153

- Height-adjustable 20" diameter foot ring
- Upright tilt lock
- 3:1 back-to-seat tilt ratio
- Center knob tension control
- 360° swivel
- Pneumatic cylinder height adjustment

WIDTH:	25.0
DEPTH:	26.0
HEIGHT:	34.0-42.0
SEAT WIDTH:	19.5
SEAT DEPTH:	18.5
SEAT HEIGHT:	24.0-32.0
BACK WIDTH:	17.5
BACK HEIGHT:	21.5
COM:	.9 YD
COL:	11.0 LB
WEIGHT:	39.0 LB

omnia

artistic. simple. beautiful.

ALL MESH

GSA SIN # 33721

- Conference, collaborative, task and stool seating
- All mesh chair
- Integrated intuitive control
- Aluminum base standard
- Warranted to 300 lbs.



CREATING OMNIA MODEL NUMBER

MODEL NUMBER	CONTROL	PLASTIC COLOR	BASE NUMBER	CASTERS	PACKAGING
286	Z2	P	BA16	C	

* IF BASE AND CASTER MODEL NUMBERS ARE LEFT BLANK THEN STANDARD OPTION WILL BE ASSUMED

PACKAGING NOTES

CODE	DESCRIPTION	LIST UPCHARGE
AB	ASSEMBLED IN BAG	\$0
BAC	BACK ASSEMBLED IN CARTON	\$0

MODEL	CONTROL	DESCRIPTION	MESH	FEATURES	DIMENSIONS
2860	Z2	SIMPLE WEIGHT-BALANCED	M 1077	<ul style="list-style-type: none"> • Automatic tension adjustment • 9° recline or upright tilt lock • 360° swivel • Pneumatic cylinder height adjustment 	WIDTH: 26.0 DEPTH: 26.0 HEIGHT: 37.5-42.5 SEAT WIDTH: 21.0 SEAT DEPTH: 18.0 SEAT HEIGHT: 15.5-20.0 BACK WIDTH: 18.5 BACK HEIGHT: 23.0 COM: N/A WEIGHT: 21.0 LB
2866	Z2	10" STOOL SIMPLE WEIGHT-BALANCED Use for work surfaces up to 42"	M 1202	<ul style="list-style-type: none"> • Height-adjustable 20" diameter foot ring • Automatic tension adjustment • 9° recline or upright lock • 360° swivel • Pneumatic cylinder height adjustment 	WIDTH: 26.0 DEPTH: 26.0 HEIGHT: 46.5-57.0 SEAT WIDTH: 21.0 SEAT DEPTH: 18.0 SEAT HEIGHT: 24.5-34.5 BACK WIDTH: 18.5 BACK HEIGHT: 23.0 COM: N/A WEIGHT: 27.0 LB
2868	Z2	8" STOOL SIMPLE WEIGHT-BALANCED Use for work surfaces up to 36"	M 1202	<ul style="list-style-type: none"> • Height-adjustable 20" diameter foot ring • Automatic tension adjustment • 9° recline or upright lock • 360° swivel • Pneumatic cylinder height adjustment 	WIDTH: 26.0 DEPTH: 26.0 HEIGHT: 43.0-51.0 SEAT WIDTH: 21.0 SEAT DEPTH: 18.0 SEAT HEIGHT: 20.5-28.5 BACK WIDTH: 18.5 BACK HEIGHT: 23.0 COM: N/A WEIGHT: 26.0 LB

BASE OPTION



27" Mid-Profile
 BA16B - Black
 BA16P - Polished
 (C7 Chrome-Accented Casters Standard with Polished Base)

CASTER OPTIONS



Large Diameter Carpet Casters



Large Diameter Hard Floor and Carpet Casters



Chrome-Accented Hard Floor and Carpet Casters

PLASTIC AND MESH COLORS

FRAME	MESH
BLACK PBK	MIDNIGHT

FRAME	MESH
WINTER WHITE PWW	PEBBLE

shuttle

the ultimate utility chair

GSA SIN # 33721

- Multipurpose seating, including stacking, side, stools and bariatric
- All plastic, upholstered seat or fully upholstered
- Wall-saver frame on select models
- Plastic back and upholstered back models warranted to 350 lbs., mesh back to 300 lbs., bariatric to 600 lbs.



PLASTIC SEAT - AP - GUEST

CREATING SHUTTLE MODEL NUMBER



PACKAGING NOTES

CODE	DESCRIPTION	LIST UPCHARGE
AB	ASSEMBLED IN BAG	\$0
AC	ASSEMBLED IN CARTON	\$0

SHUTTLE SIDE CHAIRS SHIP UP TO 3 PER CARTON (WITH TRF UP TO 2 PER CARTON)

MODEL	CONTROL	DESCRIPTION	ARM	PLASTIC	FEATURES	DIMENSIONS																						
1210	GT	PLASTIC BACK & PLASTIC SEAT GUEST STACKING - AP	A00	P 381	<ul style="list-style-type: none"> • Non-marring floor glides • Stacks 4 high on floor • Stacks 10 high on optional dolly • Wall-saver frame 	<table border="1"> <thead> <tr> <th>ARMLESS</th> <th>W/ ARMS</th> </tr> </thead> <tbody> <tr><td>WIDTH:</td><td>22.0 25.5</td></tr> <tr><td>DEPTH:</td><td>25.0 25.0</td></tr> <tr><td>HEIGHT:</td><td>33.0 33.0</td></tr> <tr><td>SEAT WIDTH:</td><td>19.5 19.5</td></tr> <tr><td>SEAT DEPTH:</td><td>17.0 17.0</td></tr> <tr><td>SEAT HEIGHT:</td><td>17.7 17.7</td></tr> <tr><td>BACK WIDTH:</td><td>20.0 20.0</td></tr> <tr><td>BACK HEIGHT:</td><td>16.0 16.0</td></tr> <tr><td>COM:</td><td>N/A N/A</td></tr> <tr><td>WEIGHT:</td><td>21.0 LB 24.0 LB</td></tr> </tbody> </table>	ARMLESS	W/ ARMS	WIDTH:	22.0 25.5	DEPTH:	25.0 25.0	HEIGHT:	33.0 33.0	SEAT WIDTH:	19.5 19.5	SEAT DEPTH:	17.0 17.0	SEAT HEIGHT:	17.7 17.7	BACK WIDTH:	20.0 20.0	BACK HEIGHT:	16.0 16.0	COM:	N/A N/A	WEIGHT:	21.0 LB 24.0 LB
ARMLESS	W/ ARMS																											
WIDTH:	22.0 25.5																											
DEPTH:	25.0 25.0																											
HEIGHT:	33.0 33.0																											
SEAT WIDTH:	19.5 19.5																											
SEAT DEPTH:	17.0 17.0																											
SEAT HEIGHT:	17.7 17.7																											
BACK WIDTH:	20.0 20.0																											
BACK HEIGHT:	16.0 16.0																											
COM:	N/A N/A																											
WEIGHT:	21.0 LB 24.0 LB																											
		A18B/G	446																									
		TRF	556																									
1215	GT	PLASTIC BACK & PLASTIC SEAT GUEST STACKING WITH CASTERS - AP	A00	P 426	<ul style="list-style-type: none"> • 50mm hooded casters • Stacks 4 high on floor • Stacks 10 high on optional dolly 	<table border="1"> <thead> <tr> <th>ARMLESS</th> <th>W/ ARMS</th> </tr> </thead> <tbody> <tr><td>WIDTH:</td><td>22.0 25.5</td></tr> <tr><td>DEPTH:</td><td>25.0 25.0</td></tr> <tr><td>HEIGHT:</td><td>33.0 33.0</td></tr> <tr><td>SEAT WIDTH:</td><td>19.5 19.5</td></tr> <tr><td>SEAT DEPTH:</td><td>17.0 17.0</td></tr> <tr><td>SEAT HEIGHT:</td><td>17.0 17.0</td></tr> <tr><td>BACK WIDTH:</td><td>20.0 20.0</td></tr> <tr><td>BACK HEIGHT:</td><td>16.0 16.0</td></tr> <tr><td>COM:</td><td>N/A N/A</td></tr> <tr><td>WEIGHT:</td><td>21.0 LB 24.0 LB</td></tr> </tbody> </table>	ARMLESS	W/ ARMS	WIDTH:	22.0 25.5	DEPTH:	25.0 25.0	HEIGHT:	33.0 33.0	SEAT WIDTH:	19.5 19.5	SEAT DEPTH:	17.0 17.0	SEAT HEIGHT:	17.0 17.0	BACK WIDTH:	20.0 20.0	BACK HEIGHT:	16.0 16.0	COM:	N/A N/A	WEIGHT:	21.0 LB 24.0 LB
ARMLESS	W/ ARMS																											
WIDTH:	22.0 25.5																											
DEPTH:	25.0 25.0																											
HEIGHT:	33.0 33.0																											
SEAT WIDTH:	19.5 19.5																											
SEAT DEPTH:	17.0 17.0																											
SEAT HEIGHT:	17.0 17.0																											
BACK WIDTH:	20.0 20.0																											
BACK HEIGHT:	16.0 16.0																											
COM:	N/A N/A																											
WEIGHT:	21.0 LB 24.0 LB																											
		A18B/G	491																									
1260	GT	MESH BACK & PLASTIC SEAT GUEST STACKING - AP	A00	P 446	<ul style="list-style-type: none"> • All mesh styles available M1, M2, M3, M4 • Non-marring floor glides • Stacks 4 high on floor • Stacks 10 high on optional dolly • Wall-saver frame 	<table border="1"> <thead> <tr> <th>ARMLESS</th> <th>W/ ARMS</th> </tr> </thead> <tbody> <tr><td>WIDTH:</td><td>22.0 25.5</td></tr> <tr><td>DEPTH:</td><td>25.0 25.0</td></tr> <tr><td>HEIGHT:</td><td>33.0 33.0</td></tr> <tr><td>SEAT WIDTH:</td><td>19.5 19.5</td></tr> <tr><td>SEAT DEPTH:</td><td>17.0 17.0</td></tr> <tr><td>SEAT HEIGHT:</td><td>17.0 17.0</td></tr> <tr><td>BACK WIDTH:</td><td>20.0 20.0</td></tr> <tr><td>BACK HEIGHT:</td><td>16.0 16.0</td></tr> <tr><td>COM:</td><td>N/A N/A</td></tr> <tr><td>WEIGHT:</td><td>21.0 LB 24.0 LB</td></tr> </tbody> </table>	ARMLESS	W/ ARMS	WIDTH:	22.0 25.5	DEPTH:	25.0 25.0	HEIGHT:	33.0 33.0	SEAT WIDTH:	19.5 19.5	SEAT DEPTH:	17.0 17.0	SEAT HEIGHT:	17.0 17.0	BACK WIDTH:	20.0 20.0	BACK HEIGHT:	16.0 16.0	COM:	N/A N/A	WEIGHT:	21.0 LB 24.0 LB
ARMLESS	W/ ARMS																											
WIDTH:	22.0 25.5																											
DEPTH:	25.0 25.0																											
HEIGHT:	33.0 33.0																											
SEAT WIDTH:	19.5 19.5																											
SEAT DEPTH:	17.0 17.0																											
SEAT HEIGHT:	17.0 17.0																											
BACK WIDTH:	20.0 20.0																											
BACK HEIGHT:	16.0 16.0																											
COM:	N/A N/A																											
WEIGHT:	21.0 LB 24.0 LB																											
		A18B/G	511																									
		TRF	621																									
1265	GT	MESH BACK & PLASTIC SEAT GUEST STACKING WITH CASTERS - AP	A00	P 491	<ul style="list-style-type: none"> • All mesh styles available M1, M2, M3, M4 • 50mm hooded casters • Stacks 4 high on floor • Stacks 10 high on optional dolly 	<table border="1"> <thead> <tr> <th>ARMLESS</th> <th>W/ ARMS</th> </tr> </thead> <tbody> <tr><td>WIDTH:</td><td>22.0 25.5</td></tr> <tr><td>DEPTH:</td><td>25.0 25.0</td></tr> <tr><td>HEIGHT:</td><td>33.0 33.0</td></tr> <tr><td>SEAT WIDTH:</td><td>19.5 19.5</td></tr> <tr><td>SEAT DEPTH:</td><td>17.0 17.0</td></tr> <tr><td>SEAT HEIGHT:</td><td>17.0 17.0</td></tr> <tr><td>BACK WIDTH:</td><td>20.0 20.0</td></tr> <tr><td>BACK HEIGHT:</td><td>16.0 16.0</td></tr> <tr><td>COM:</td><td>N/A N/A</td></tr> <tr><td>WEIGHT:</td><td>21.0 LB 24.0 LB</td></tr> </tbody> </table>	ARMLESS	W/ ARMS	WIDTH:	22.0 25.5	DEPTH:	25.0 25.0	HEIGHT:	33.0 33.0	SEAT WIDTH:	19.5 19.5	SEAT DEPTH:	17.0 17.0	SEAT HEIGHT:	17.0 17.0	BACK WIDTH:	20.0 20.0	BACK HEIGHT:	16.0 16.0	COM:	N/A N/A	WEIGHT:	21.0 LB 24.0 LB
ARMLESS	W/ ARMS																											
WIDTH:	22.0 25.5																											
DEPTH:	25.0 25.0																											
HEIGHT:	33.0 33.0																											
SEAT WIDTH:	19.5 19.5																											
SEAT DEPTH:	17.0 17.0																											
SEAT HEIGHT:	17.0 17.0																											
BACK WIDTH:	20.0 20.0																											
BACK HEIGHT:	16.0 16.0																											
COM:	N/A N/A																											
WEIGHT:	21.0 LB 24.0 LB																											
		A18B/G	556																									

ARM OPTIONS

A18B/G
\$65

Soft Touch Polyurethane Arm
A18B - Black
A18G - Gray

TRF
\$175

Right Tablet Arm (Available with Black Frame Only)
Tablet size: 12.5" x 23.25" x .75"

CASTER OPTIONS

C5
STD

Carpet Casters

C5S
\$30

Hard Floor and Carpet Casters

ADDITIONAL OPTIONS

G18
STD

Dome Glide

G8
\$20

Swivel Steel Glide
4 per Set

G9
\$20

Swivel Nylon Glide
4 per Set

G10
\$20

Swivel Felt Glide
4 per Set

ACCESSORIES

DL5
\$399

Stacking Dolly
Stacks Chairs 10 High Four Legs Only

GC1
\$30

GC2
\$30

Ganging Clip - 2 per Set
GC1 - Armless-to-Armless
GC2 - Arm-to-Arm

BRK
\$70

Book Rack in Black Only
Available on All Models
*Not Stackable with BRK

FRAME COLORS

BLACK BF	SILVER BF
----------	-----------

- M1 MESH**
- NC**
- M2, M3, M4**
- \$30**

MESH COLORS

M1	BLACK M11	GRAY M12	SILVER M13			
M2	BLACK M21	GRAY M22	WHITE M23	GREEN M24	RED M25	
M2	BLUE M26	ORANGE M27	AQUA M28			
M3	GRAPHITE M31	SLATE M32	SNOW M33			
M4	LATTE M40	CLOUD M41	LEMON M42	APPLE M43	TANGERINE M44	CRIMSON M46
M4	ONYX M48	DOVE M49	AZURE M50	FEDERAL BLUE M51	WHITE WHISPER M52	

PLASTIC COLORS

BLACK SWAN P01	WHITE WHISPER P05	FEDERAL BLUE P11	CRIMSON RED P12	LEMON YELLOW P13	DOVE GRAY P14
CLOUD GRAY P15	LAGOON BLUE P16	APPLE GREEN P17	TANGERINE ORANGE P18	LATTE P19	AZURE BLUE P20

(BACK & SEAT)

CAUTION: Careless stacking of chairs may scratch and damage frames.

shuttle

the ultimate utility chair

GSA SIN # 33721

- Multipurpose seating, including stacking, side, stools and bariatric
- All plastic, upholstered seat or fully upholstered
- Wall-saver frame on select models
- Plastic back and upholstered back models warranted to 350 lbs., mesh back to 300 lbs., bariatric to 600 lbs.



CREATING SHUTTLE MODEL NUMBER

MODEL NUMBER CONTROL ARMS FRAME COLOR UPHOLSTERY PLASTIC COLOR PACKAGING OPTIONS

1 2 - S T - A - F - A P - P -

* FOR ARMLESS USE CODE A00

PACKAGING NOTES

CODE	DESCRIPTION	LIST UPCHARGE
AB	ASSEMBLED IN BAG	\$0
AC	ASSEMBLED IN CARTON	\$0

SHUTTLE STOOLS SHIP 1 PER CARTON

PLASTIC SEAT - AP - STOOLS

MODEL	CONTROL	DESCRIPTION	ARM	PLASTIC	FEATURES	DIMENSIONS
1210	ST27	PLASTIC BACK & PLASTIC SEAT 27" COUNTER STOOL - AP Use for work surfaces up to 36" high	A00 A18B/G	P 511 576	<ul style="list-style-type: none"> • Counter height stool • Non-marring floor glides • Foot rest 	ARMLESS W/ ARMS WIDTH: 22.0 25.5 DEPTH: 25.0 25.0 HEIGHT: 42.0 42.0 SEAT WIDTH: 19.5 19.5 SEAT DEPTH: 17.0 17.0 SEAT HEIGHT: 27.0 27.0 BACK WIDTH: 20.0 20.0 BACK HEIGHT: 16.0 16.0 COM: N/A N/A WEIGHT: 22.5 LB 25.5 LB
1210	ST30	PLASTIC BACK & PLASTIC SEAT 30" BAR STOOL - AP Use for work surfaces up to 42" high	A00 A18B/G	P 531 596	<ul style="list-style-type: none"> • Bar height stool • Non-marring floor glides • Foot rest 	WIDTH: 22.0 25.5 DEPTH: 25.0 25.0 HEIGHT: 45.0 45.0 SEAT WIDTH: 19.5 19.5 SEAT DEPTH: 17.0 17.0 SEAT HEIGHT: 30.0 30.0 BACK WIDTH: 20.0 20.0 BACK HEIGHT: 16.0 16.0 COM: N/A N/A WEIGHT: 23.0 LB 26.0 LB
1260	ST27	MESH BACK & PLASTIC SEAT 27" COUNTER STOOL - AP Use for work surfaces up to 36" high	A00 A18B/G	P 576 641	<ul style="list-style-type: none"> • All mesh styles available M1, M2, M3, M4 • Counter height stool • Non-marring floor glides • Foot rest 	WIDTH: 22.0 25.5 DEPTH: 25.0 25.0 HEIGHT: 42.0 42.0 SEAT WIDTH: 19.5 19.5 SEAT DEPTH: 17.0 17.0 SEAT HEIGHT: 27.0 27.0 BACK WIDTH: 20.0 20.0 BACK HEIGHT: 16.0 16.0 COM: N/A N/A WEIGHT: 22.5 LB 25.5 LB
1260	ST30	MESH BACK & PLASTIC SEAT 30" BAR STOOL - AP Use for work surfaces up to 42" high	A00 A18B/G	P 596 661	<ul style="list-style-type: none"> • All mesh styles available M1, M2, M3, M4 • Bar height stool • Non-marring floor glides • Foot rest 	WIDTH: 22.0 25.5 DEPTH: 25.0 25.0 HEIGHT: 45.0 45.0 SEAT WIDTH: 19.5 19.5 SEAT DEPTH: 17.0 17.0 SEAT HEIGHT: 30.0 30.0 BACK WIDTH: 20.0 20.0 BACK HEIGHT: 16.0 16.0 COM: N/A N/A WEIGHT: 23.0 LB 26.0 LB

ARM OPTIONS

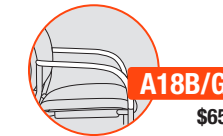

Soft Touch Polyurethane Arm
A18B - Black
A18G - Gray

ADDITIONAL OPTIONS

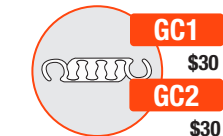

Ganging Clip - 2 per Set
GC1 - Armless-to-Armless
GC2 - Arm-to-Arm

FRAME COLORS

BLACK BF	SILVER SF
-------------	--------------

MESH COLORS

	BLACK M11	GRAY M12	SILVER M13			
M2	BLACK M21	GRAY M22	WHITE M23	GREEN M24	RED M25	
M2	BLUE M26	ORANGE M27	AQUA M28			
M3	GRAPHITE M31	SLATE M32	SNOW M33			
M4	LATTE M40	CLOUD M41	LEMON M42	APPLE M43	TANGERINE M44	CRIMSON M46
M4	ONYX M48	DOVE M49	AZURE M50	FEDERAL BLUE M51	WHITE WHISPER M52	

M1 MESH NC **M2, M3, M4** \$30

PLASTIC COLORS

BLACK SWAN P01	WHITE WHISPER P05	FEDERAL BLUE P11	CRIMSON RED P12	LEMON YELLOW P13	DOVE GRAY P14
CLOUD GRAY P15	LAGOON BLUE P16	APPLE GREEN P17	TANGERINE ORANGE P18	LATTE P19	AZURE BLUE P20

(BACK & SEAT)

shuttle

the ultimate utility chair

GSA SIN # 33721

- Multipurpose seating, including stacking, side, stools and bariatric
- All plastic, upholstered seat or fully upholstered
- Wall-saver frame on select models
- Plastic back and upholstered back models warranted to 350 lbs., mesh back to 300 lbs., bariatric to 600 lbs.



PLASTIC SEAT - AP - SLED

CREATING SHUTTLE MODEL NUMBER



PACKAGING NOTES

CODE	DESCRIPTION	LIST UPCHARGE
AB	ASSEMBLED IN BAG	\$0
AC	ASSEMBLED IN CARTON	\$0

SLED BASE CHAIRS SHIP 2 ARMLESS PER CARTON, 1 WITH ARMS

MODEL	CONTROL	DESCRIPTION	ARM	PLASTIC	FEATURES	DIMENSIONS
1230	GT	<p>PLASTIC BACK & PLASTIC SEAT SLED BASE GUEST - AP</p>	A00	P 481	<ul style="list-style-type: none"> • Non-marring floor glides • Wall-saver frame 	<p>ARMLESS W/ ARMS</p> <p>WIDTH: 22.0 25.5</p> <p>DEPTH: 25.0 25.0</p> <p>HEIGHT: 33.0 33.0</p> <p>SEAT WIDTH: 19.5 19.5</p> <p>SEAT DEPTH: 17.0 17.0</p> <p>SEAT HEIGHT: 17.0 17.0</p> <p>BACK WIDTH: 20.0 20.0</p> <p>BACK HEIGHT: 16.0 16.0</p> <p>WEIGHT: 21.0 LB 24.0 LB</p>
			A18B/G	546		
1280	GT	<p>MESH BACK & PLASTIC SEAT SLED BASE GUEST - AP</p>	A00	P 546	<ul style="list-style-type: none"> • All mesh styles available M1, M2, M3, M4 • Non-marring floor glides • Wall-saver frame 	<p>WIDTH: 22.0 25.5</p> <p>DEPTH: 25.0 25.0</p> <p>HEIGHT: 33.0 33.0</p> <p>SEAT WIDTH: 19.5 19.5</p> <p>SEAT DEPTH: 17.0 17.0</p> <p>SEAT HEIGHT: 17.0 17.0</p> <p>BACK WIDTH: 20.0 20.0</p> <p>BACK HEIGHT: 16.0 16.0</p> <p>WEIGHT: 21.0 LB 24.0 LB</p>
			A18B/G	611		

ARM OPTIONS

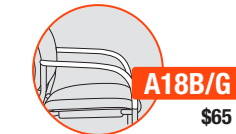

Soft Touch Polyurethane
A18B - Black
A18G - Gray

ADDITIONAL OPTIONS

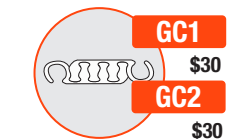

Ganging Clip - 2 per Set
GC1 - Armless-to-Armless
GC2 - Arm-to-Arm

FRAME COLORS

BLACK BF	SILVER SF
-------------	--------------

MESH COLORS

M1	BLACK M11	GRAY M12	SILVER M13			
M2	BLACK M21	GRAY M22	WHITE M23	GREEN M24	RED M25	
M2	BLUE M26	ORANGE M27	AQUA M28			
M3	GRAPHITE M31	SLATE M32	SNOW M33			
M4	LATTE M40	CLOUD M41	LEMON M42	APPLE M43	TANGERINE M44	CRIMSON M46
M4	ONYX M48	DOVE M49	AZURE M50	FEDERAL BLUE M51	WHITE WHISPER M52	

M1 MESH NC **M2, M3, M4** \$30

PLASTIC COLORS

BLACK SWAN P01	WHITE WHISPER P05	FEDERAL BLUE P11	CRIMSON RED P12	LEMON YELLOW P13	DOVE GRAY P14
CLOUD GRAY P15	LAGOON BLUE P16	APPLE GREEN P17	TANGERINE ORANGE P18	LATTE P19	AZURE BLUE P20

(BACK & SEAT)

shuttle

the ultimate utility chair

GSA SIN # 33721

- Multipurpose seating, including stacking, side, stools and bariatric
- All plastic, upholstered seat or fully upholstered
- Wall-saver frame on select models
- Plastic back and upholstered back models warranted to 350 lbs., mesh back to 300 lbs., bariatric to 600 lbs.



UPHOLSTERED SEAT - US - GUEST

CREATING SHUTTLE MODEL NUMBER



PACKAGING NOTES

CODE	DESCRIPTION	LIST UPCHARGE
AB	ASSEMBLED IN BAG	\$0
AC	ASSEMBLED IN CARTON	\$0

SHUTTLE SIDE CHAIRS SHIP UP TO 3 PER CARTON (WITH TLF/TRF UP TO 2 PER CARTON)

MODEL	CONTROL	DESCRIPTION	ARM	FABRIC	FEATURES	DIMENSIONS	ARM OPTIONS		ACCESSORIES												
							ARMLESS	W/ ARMS													
1210	GT	PLASTIC BACK & UPHOLSTERED SEAT GUEST STACKING - US	A00	A B/COM C D E F G L3/COL L4 L5	<ul style="list-style-type: none"> • Non-marring floor glides • Stacks 4 high on floor • Stacks 10 high on optional dolly • Wall-saver frame 	WIDTH: 22.0 25.5 DEPTH: 25.0 25.0 HEIGHT: 33.0 33.0 SEAT WIDTH: 19.5 19.5 SEAT DEPTH: 17.0 17.0 SEAT HEIGHT: 17.7 17.7 BACK WIDTH: 20.0 20.0 BACK HEIGHT: 16.0 16.0 COM: 1.2 YD 1.2 YD WEIGHT: 21.0 LB 24.0 LB	A18B/G	421 446 474 508 566 621 654 531 556 586	A18B/G	486 511 539 573 631 686 719 596 621 651	TRF	596 621 649 683 741 796 829 706 731 761	TRF	\$175	DL5	\$399					
			A00	466 491 519 553 611 666 699 576 601 631			A18B/G	531 556 584 618 676 731 764 641 666 696													
			1260	GT			MESH BACK & UPHOLSTERED SEAT GUEST STACKING - US	A00	A B/COM C D E F G L3/COL L4 L5	<ul style="list-style-type: none"> • All mesh styles available M1, M2, M3, M4 • Non-marring floor glides • Stacks 4 high on floor • Stacks 10 high on optional dolly • Wall-saver frame 	WIDTH: 22.0 25.5 DEPTH: 25.0 25.0 HEIGHT: 33.0 33.0 SEAT WIDTH: 19.5 19.5 SEAT DEPTH: 17.0 17.0 SEAT HEIGHT: 17.0 17.0 BACK WIDTH: 20.0 20.0 BACK HEIGHT: 16.0 16.0 COM: 0.8 YD 0.8 YD WEIGHT: 21.0 LB 24.0 LB	A18B/G	486 511 539 573 631 686 719 596 621 651	A18B/G	551 576 604 638 696 751 784 661 686 716	TRF	661 686 714 748 806 861 894 771 796 826				
								A00	531 556 584 618 676 731 764 641 666 696			A18B/G	596 621 649 683 741 796 829 706 731 761								

CAUTION: Careless stacking of chairs may scratch and damage frames.

MESH COLORS

M1	BLACK M11	GRAY M12	SILVER M13			
M2	BLACK M21	GRAY M22	WHITE M23	GREEN M24	RED M25	
M2	BLUE M26	ORANGE M27	AQUA M28			
M3	GRAPHITE M31	SLATE M32	SNOW M33			
M4	LATTE M40	CLOUD M41	LEMON M42	APPLE M43	TANGERINE M44	CRIMSON M46
M4	ONYX M48	DOVE M49	AZURE M50	FEDERAL BLUE M51	WHITE WHISPER M52	

BLACK BF	SILVER BF
----------	-----------

M1 MESH
NC
M2, M3, M4
\$30

PLASTIC COLORS

BLACK SWAN P01	WHITE WHISPER P05	FEDERAL BLUE P11	CRIMSON RED P12	LEMON YELLOW P13	DOVE GRAY P14
CLOUD GRAY P15	LAGOON BLUE P16	APPLE GREEN P17	TANGERINE ORANGE P18	LATTE P19	AZURE BLUE P20

shuttle

the ultimate utility chair

GSA SIN # 33721

- Multipurpose seating, including stacking, side, stools and bariatric
- All plastic, upholstered seat or fully upholstered
- Wall-saver frame on select models
- Plastic back and upholstered back models warranted to 350 lbs., mesh back to 300 lbs., bariatric to 600 lbs.



CREATING SHUTTLE MODEL NUMBER

MODEL NUMBER CONTROL ARMS FRAME COLOR UPHOLSTERY PLASTIC COLOR GRADE PACKAGING OPTIONS

1 2 - S T - A - F - U S - P - - - -





* FOR ARMLESS USE CODE A00

PACKAGING NOTES

CODE	DESCRIPTION	LIST UPCHARGE
AB	ASSEMBLED IN BAG	\$0
AC	ASSEMBLED IN CARTON	\$0

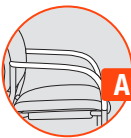
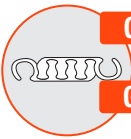
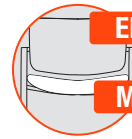
SHUTTLE STOOLS SHIP UP TO 1 PER CARTON

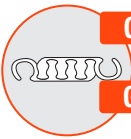
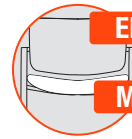
UPHOLSTERED SEAT - US - STOOLS

MODEL	CONTROL	DESCRIPTION	ARM	FABRIC	FEATURES	DIMENSIONS	ARM OPTIONS																																																																																																																																																																																																																																																																				
							ARMLESS	W/ ARMS																																																																																																																																																																																																																																																																			
1210	ST27	PLASTIC BACK & UPHOLSTERED SEAT 27" COUNTER STOOL - US Use for work surfaces up to 36" high	A00	<table border="1"> <thead> <tr> <th>A</th><th>B/COM</th><th>C</th><th>D</th><th>E</th><th>F</th><th>G</th><th>L3/COL</th><th>L4</th><th>L5</th> </tr> </thead> <tbody> <tr> <td>576</td><td>601</td><td>629</td><td>663</td><td>721</td><td>776</td><td>809</td><td>686</td><td>711</td><td>741</td> </tr> </tbody> </table>	A	B/COM	C	D	E	F	G	L3/COL	L4	L5	576	601	629	663	721	776	809	686	711	741	<ul style="list-style-type: none"> • Counter height stool • Non-marring floor glides • Foot rest 	<table border="1"> <thead> <tr> <th>WIDTH:</th><td>22.0</td><td>25.5</td> </tr> <tr> <th>DEPTH:</th><td>25.0</td><td>25.0</td> </tr> <tr> <th>HEIGHT:</th><td>42.0</td><td>42.0</td> </tr> <tr> <th>SEAT WIDTH:</th><td>19.5</td><td>19.5</td> </tr> <tr> <th>SEAT DEPTH:</th><td>17.0</td><td>17.0</td> </tr> <tr> <th>SEAT HEIGHT:</th><td>27.0</td><td>27.0</td> </tr> <tr> <th>BACK WIDTH:</th><td>20.0</td><td>20.0</td> </tr> <tr> <th>BACK HEIGHT:</th><td>16.0</td><td>16.0</td> </tr> <tr> <th>COM:</th><td>1.2 YD</td><td>1.2 YD</td> </tr> <tr> <th>WEIGHT:</th><td>25.0 LB</td><td>28.0 LB</td> </tr> </thead></table>	WIDTH:	22.0	25.5	DEPTH:	25.0	25.0	HEIGHT:	42.0	42.0	SEAT WIDTH:	19.5	19.5	SEAT DEPTH:	17.0	17.0	SEAT HEIGHT:	27.0	27.0	BACK WIDTH:	20.0	20.0	BACK HEIGHT:	16.0	16.0	COM:	1.2 YD	1.2 YD	WEIGHT:	25.0 LB	28.0 LB	 A18B/G \$65 Soft Touch Polyurethane Arm A18B - Black A18G - Gray																																																																																																																																																																																																																		
	A		B/COM	C	D	E	F	G	L3/COL	L4	L5																																																																																																																																																																																																																																																																
576	601	629	663	721	776	809	686	711	741																																																																																																																																																																																																																																																																		
WIDTH:	22.0	25.5																																																																																																																																																																																																																																																																									
DEPTH:	25.0	25.0																																																																																																																																																																																																																																																																									
HEIGHT:	42.0	42.0																																																																																																																																																																																																																																																																									
SEAT WIDTH:	19.5	19.5																																																																																																																																																																																																																																																																									
SEAT DEPTH:	17.0	17.0																																																																																																																																																																																																																																																																									
SEAT HEIGHT:	27.0	27.0																																																																																																																																																																																																																																																																									
BACK WIDTH:	20.0	20.0																																																																																																																																																																																																																																																																									
BACK HEIGHT:	16.0	16.0																																																																																																																																																																																																																																																																									
COM:	1.2 YD	1.2 YD																																																																																																																																																																																																																																																																									
WEIGHT:	25.0 LB	28.0 LB																																																																																																																																																																																																																																																																									
	A18B/G	<table border="1"> <thead> <tr> <th>A</th><th>B/COM</th><th>C</th><th>D</th><th>E</th><th>F</th><th>G</th><th>L3/COL</th><th>L4</th><th>L5</th> </tr> </thead> <tbody> <tr> <td>641</td><td>666</td><td>694</td><td>728</td><td>786</td><td>841</td><td>874</td><td>751</td><td>776</td><td>806</td> </tr> </tbody> </table>	A	B/COM	C	D	E	F	G	L3/COL	L4	L5	641	666	694	728	786	841	874	751	776	806	1210	ST30	PLASTIC BACK & UPHOLSTERED SEAT 30" BAR STOOL - US Use for work surfaces up to 42" high	A00	<table border="1"> <thead> <tr> <th>A</th><th>B/COM</th><th>C</th><th>D</th><th>E</th><th>F</th><th>G</th><th>L3/COL</th><th>L4</th><th>L5</th> </tr> </thead> <tbody> <tr> <td>596</td><td>621</td><td>649</td><td>683</td><td>741</td><td>796</td><td>829</td><td>706</td><td>731</td><td>761</td> </tr> </tbody> </table>	A	B/COM	C	D	E	F	G	L3/COL	L4	L5	596	621	649	683	741	796	829	706	731	761	<ul style="list-style-type: none"> • Bar height stool • Non-marring floor glides • Foot rest 	<table border="1"> <thead> <tr> <th>WIDTH:</th><td>22.0</td><td>25.5</td> </tr> <tr> <th>DEPTH:</th><td>25.0</td><td>25.0</td> </tr> <tr> <th>HEIGHT:</th><td>45.0</td><td>45.0</td> </tr> <tr> <th>SEAT WIDTH:</th><td>19.5</td><td>19.5</td> </tr> <tr> <th>SEAT DEPTH:</th><td>17.0</td><td>17.0</td> </tr> <tr> <th>SEAT HEIGHT:</th><td>30.0</td><td>30.0</td> </tr> <tr> <th>BACK WIDTH:</th><td>20.0</td><td>20.0</td> </tr> <tr> <th>BACK HEIGHT:</th><td>16.0</td><td>16.0</td> </tr> <tr> <th>COM:</th><td>1.2 YD</td><td>1.2 YD</td> </tr> <tr> <th>WEIGHT:</th><td>25.5 LB</td><td>28.5 LB</td> </tr> </thead></table>	WIDTH:	22.0	25.5	DEPTH:	25.0	25.0	HEIGHT:	45.0	45.0	SEAT WIDTH:	19.5	19.5	SEAT DEPTH:	17.0	17.0	SEAT HEIGHT:	30.0	30.0	BACK WIDTH:	20.0	20.0	BACK HEIGHT:	16.0	16.0	COM:	1.2 YD	1.2 YD	WEIGHT:	25.5 LB	28.5 LB	 GC1 \$30 Ganging Clip - 2 per Set GC1 - Armless-to-Armless GC2 - Arm-to-Arm	 EF2 \$30 EF2 - 2" Extra Foam on Seat	 MF1 \$50 MF1 - 1" Visco Elastic Memory Foam on Seat		A18B/G	<table border="1"> <thead> <tr> <th>A</th><th>B/COM</th><th>C</th><th>D</th><th>E</th><th>F</th><th>G</th><th>L3/COL</th><th>L4</th><th>L5</th> </tr> </thead> <tbody> <tr> <td>661</td><td>686</td><td>714</td><td>748</td><td>806</td><td>861</td><td>894</td><td>771</td><td>796</td><td>826</td> </tr> </tbody> </table>	A	B/COM	C	D	E	F	G	L3/COL	L4	L5	661	686	714	748	806	861	894	771	796	826	1260	ST27	MESH BACK & UPHOLSTERED SEAT 27" COUNTER STOOL - US Use for work surfaces up to 36" high	A00	<table border="1"> <thead> <tr> <th>A</th><th>B/COM</th><th>C</th><th>D</th><th>E</th><th>F</th><th>G</th><th>L3/COL</th><th>L4</th><th>L5</th> </tr> </thead> <tbody> <tr> <td>641</td><td>666</td><td>694</td><td>728</td><td>786</td><td>841</td><td>874</td><td>751</td><td>776</td><td>806</td> </tr> </tbody> </table>	A	B/COM	C	D	E	F	G	L3/COL	L4	L5	641	666	694	728	786	841	874	751	776	806	<ul style="list-style-type: none"> • All mesh styles available M1, M2, M3, M4 • Counter height stool • Non-marring floor glides • Foot rest 	<table border="1"> <thead> <tr> <th>WIDTH:</th><td>22.0</td><td>25.5</td> </tr> <tr> <th>DEPTH:</th><td>25.0</td><td>25.0</td> </tr> <tr> <th>HEIGHT:</th><td>39.0</td><td>39.0</td> </tr> <tr> <th>SEAT WIDTH:</th><td>19.5</td><td>19.5</td> </tr> <tr> <th>SEAT DEPTH:</th><td>17.0</td><td>17.0</td> </tr> <tr> <th>SEAT HEIGHT:</th><td>27.0</td><td>27.0</td> </tr> <tr> <th>BACK WIDTH:</th><td>20.0</td><td>20.0</td> </tr> <tr> <th>BACK HEIGHT:</th><td>16.0</td><td>16.0</td> </tr> <tr> <th>COM:</th><td>0.8 YD</td><td>0.8 YD</td> </tr> <tr> <th>WEIGHT:</th><td>25.0 LB</td><td>28.0 LB</td> </tr> </thead></table>	WIDTH:	22.0	25.5	DEPTH:	25.0	25.0	HEIGHT:	39.0	39.0	SEAT WIDTH:	19.5	19.5	SEAT DEPTH:	17.0	17.0	SEAT HEIGHT:	27.0	27.0	BACK WIDTH:	20.0	20.0	BACK HEIGHT:	16.0	16.0	COM:	0.8 YD	0.8 YD	WEIGHT:	25.0 LB	28.0 LB	M1 MESH NC M2, M3, M4 \$30		A18B/G	<table border="1"> <thead> <tr> <th>A</th><th>B/COM</th><th>C</th><th>D</th><th>E</th><th>F</th><th>G</th><th>L3/COL</th><th>L4</th><th>L5</th> </tr> </thead> <tbody> <tr> <td>706</td><td>731</td><td>759</td><td>793</td><td>851</td><td>906</td><td>939</td><td>816</td><td>841</td><td>871</td> </tr> </tbody> </table>	A	B/COM	C	D	E	F	G	L3/COL	L4	L5	706	731	759	793	851	906	939	816	841	871	1260	ST30	MESH BACK & UPHOLSTERED SEAT 30" BAR STOOL - US Use for work surfaces up to 42" high	A00	<table border="1"> <thead> <tr> <th>A</th><th>B/COM</th><th>C</th><th>D</th><th>E</th><th>F</th><th>G</th><th>L3/COL</th><th>L4</th><th>L5</th> </tr> </thead> <tbody> <tr> <td>661</td><td>686</td><td>714</td><td>748</td><td>806</td><td>861</td><td>894</td><td>771</td><td>796</td><td>826</td> </tr> </tbody> </table>	A	B/COM	C	D	E	F	G	L3/COL	L4	L5	661	686	714	748	806	861	894	771	796	826	<ul style="list-style-type: none"> • All mesh styles available M1, M2, M3, M4 • Bar height stool • Non-marring floor glides • Foot rest 	<table border="1"> <thead> <tr> <th>WIDTH:</th><td>22.0</td><td>25.5</td> </tr> <tr> <th>DEPTH:</th><td>25.0</td><td>25.0</td> </tr> <tr> <th>HEIGHT:</th><td>42.0</td><td>42.0</td> </tr> <tr> <th>SEAT WIDTH:</th><td>19.5</td><td>19.5</td> </tr> <tr> <th>SEAT DEPTH:</th><td>17.0</td><td>17.0</td> </tr> <tr> <th>SEAT HEIGHT:</th><td>27.0</td><td>27.0</td> </tr> <tr> <th>BACK WIDTH:</th><td>20.0</td><td>20.0</td> </tr> <tr> <th>BACK HEIGHT:</th><td>16.0</td><td>16.0</td> </tr> <tr> <th>COM:</th><td>0.8 YD</td><td>0.8 YD</td> </tr> <tr> <th>WEIGHT:</th><td>25.5 LB</td><td>28.5 LB</td> </tr> </thead></table>	WIDTH:	22.0	25.5	DEPTH:	25.0	25.0	HEIGHT:	42.0	42.0	SEAT WIDTH:	19.5	19.5	SEAT DEPTH:	17.0	17.0	SEAT HEIGHT:	27.0	27.0	BACK WIDTH:	20.0	20.0	BACK HEIGHT:	16.0	16.0	COM:	0.8 YD	0.8 YD	WEIGHT:	25.5 LB	28.5 LB	M1 MESH NC M2, M3, M4 \$30		A18B/G	<table border="1"> <thead> <tr> <th>A</th><th>B/COM</th><th>C</th><th>D</th><th>E</th><th>F</th><th>G</th><th>L3/COL</th><th>L4</th><th>L5</th> </tr> </thead> <tbody> <tr> <td>726</td><td>751</td><td>779</td><td>813</td><td>871</td><td>926</td><td>959</td><td>836</td><td>861</td><td>891</td> </tr> </tbody> </table>	A	B/COM	C	D	E	F	G	L3/COL	L4	L5	726	751	779	813	871	926	959	836	861	891
A	B/COM	C	D	E	F	G	L3/COL	L4	L5																																																																																																																																																																																																																																																																		
641	666	694	728	786	841	874	751	776	806																																																																																																																																																																																																																																																																		
1210	ST30	PLASTIC BACK & UPHOLSTERED SEAT 30" BAR STOOL - US Use for work surfaces up to 42" high	A00	<table border="1"> <thead> <tr> <th>A</th><th>B/COM</th><th>C</th><th>D</th><th>E</th><th>F</th><th>G</th><th>L3/COL</th><th>L4</th><th>L5</th> </tr> </thead> <tbody> <tr> <td>596</td><td>621</td><td>649</td><td>683</td><td>741</td><td>796</td><td>829</td><td>706</td><td>731</td><td>761</td> </tr> </tbody> </table>	A	B/COM	C	D	E	F	G	L3/COL	L4	L5	596	621	649	683	741	796	829	706	731	761	<ul style="list-style-type: none"> • Bar height stool • Non-marring floor glides • Foot rest 	<table border="1"> <thead> <tr> <th>WIDTH:</th><td>22.0</td><td>25.5</td> </tr> <tr> <th>DEPTH:</th><td>25.0</td><td>25.0</td> </tr> <tr> <th>HEIGHT:</th><td>45.0</td><td>45.0</td> </tr> <tr> <th>SEAT WIDTH:</th><td>19.5</td><td>19.5</td> </tr> <tr> <th>SEAT DEPTH:</th><td>17.0</td><td>17.0</td> </tr> <tr> <th>SEAT HEIGHT:</th><td>30.0</td><td>30.0</td> </tr> <tr> <th>BACK WIDTH:</th><td>20.0</td><td>20.0</td> </tr> <tr> <th>BACK HEIGHT:</th><td>16.0</td><td>16.0</td> </tr> <tr> <th>COM:</th><td>1.2 YD</td><td>1.2 YD</td> </tr> <tr> <th>WEIGHT:</th><td>25.5 LB</td><td>28.5 LB</td> </tr> </thead></table>	WIDTH:	22.0	25.5	DEPTH:	25.0	25.0	HEIGHT:	45.0	45.0	SEAT WIDTH:	19.5	19.5	SEAT DEPTH:	17.0	17.0	SEAT HEIGHT:	30.0	30.0	BACK WIDTH:	20.0	20.0	BACK HEIGHT:	16.0	16.0	COM:	1.2 YD	1.2 YD	WEIGHT:	25.5 LB	28.5 LB	 GC1 \$30 Ganging Clip - 2 per Set GC1 - Armless-to-Armless GC2 - Arm-to-Arm	 EF2 \$30 EF2 - 2" Extra Foam on Seat	 MF1 \$50 MF1 - 1" Visco Elastic Memory Foam on Seat																																																																																																																																																																																																																
	A		B/COM	C	D	E	F	G	L3/COL	L4	L5																																																																																																																																																																																																																																																																
596	621	649	683	741	796	829	706	731	761																																																																																																																																																																																																																																																																		
WIDTH:	22.0	25.5																																																																																																																																																																																																																																																																									
DEPTH:	25.0	25.0																																																																																																																																																																																																																																																																									
HEIGHT:	45.0	45.0																																																																																																																																																																																																																																																																									
SEAT WIDTH:	19.5	19.5																																																																																																																																																																																																																																																																									
SEAT DEPTH:	17.0	17.0																																																																																																																																																																																																																																																																									
SEAT HEIGHT:	30.0	30.0																																																																																																																																																																																																																																																																									
BACK WIDTH:	20.0	20.0																																																																																																																																																																																																																																																																									
BACK HEIGHT:	16.0	16.0																																																																																																																																																																																																																																																																									
COM:	1.2 YD	1.2 YD																																																																																																																																																																																																																																																																									
WEIGHT:	25.5 LB	28.5 LB																																																																																																																																																																																																																																																																									
	A18B/G	<table border="1"> <thead> <tr> <th>A</th><th>B/COM</th><th>C</th><th>D</th><th>E</th><th>F</th><th>G</th><th>L3/COL</th><th>L4</th><th>L5</th> </tr> </thead> <tbody> <tr> <td>661</td><td>686</td><td>714</td><td>748</td><td>806</td><td>861</td><td>894</td><td>771</td><td>796</td><td>826</td> </tr> </tbody> </table>	A	B/COM	C	D	E	F	G	L3/COL	L4	L5	661	686	714	748	806	861	894	771	796	826	1260	ST27	MESH BACK & UPHOLSTERED SEAT 27" COUNTER STOOL - US Use for work surfaces up to 36" high	A00	<table border="1"> <thead> <tr> <th>A</th><th>B/COM</th><th>C</th><th>D</th><th>E</th><th>F</th><th>G</th><th>L3/COL</th><th>L4</th><th>L5</th> </tr> </thead> <tbody> <tr> <td>641</td><td>666</td><td>694</td><td>728</td><td>786</td><td>841</td><td>874</td><td>751</td><td>776</td><td>806</td> </tr> </tbody> </table>	A	B/COM	C	D	E	F	G	L3/COL	L4	L5	641	666	694	728	786	841	874	751	776	806	<ul style="list-style-type: none"> • All mesh styles available M1, M2, M3, M4 • Counter height stool • Non-marring floor glides • Foot rest 	<table border="1"> <thead> <tr> <th>WIDTH:</th><td>22.0</td><td>25.5</td> </tr> <tr> <th>DEPTH:</th><td>25.0</td><td>25.0</td> </tr> <tr> <th>HEIGHT:</th><td>39.0</td><td>39.0</td> </tr> <tr> <th>SEAT WIDTH:</th><td>19.5</td><td>19.5</td> </tr> <tr> <th>SEAT DEPTH:</th><td>17.0</td><td>17.0</td> </tr> <tr> <th>SEAT HEIGHT:</th><td>27.0</td><td>27.0</td> </tr> <tr> <th>BACK WIDTH:</th><td>20.0</td><td>20.0</td> </tr> <tr> <th>BACK HEIGHT:</th><td>16.0</td><td>16.0</td> </tr> <tr> <th>COM:</th><td>0.8 YD</td><td>0.8 YD</td> </tr> <tr> <th>WEIGHT:</th><td>25.0 LB</td><td>28.0 LB</td> </tr> </thead></table>	WIDTH:	22.0	25.5	DEPTH:	25.0	25.0	HEIGHT:	39.0	39.0	SEAT WIDTH:	19.5	19.5	SEAT DEPTH:	17.0	17.0	SEAT HEIGHT:	27.0	27.0	BACK WIDTH:	20.0	20.0	BACK HEIGHT:	16.0	16.0	COM:	0.8 YD	0.8 YD	WEIGHT:	25.0 LB	28.0 LB	M1 MESH NC M2, M3, M4 \$30		A18B/G	<table border="1"> <thead> <tr> <th>A</th><th>B/COM</th><th>C</th><th>D</th><th>E</th><th>F</th><th>G</th><th>L3/COL</th><th>L4</th><th>L5</th> </tr> </thead> <tbody> <tr> <td>706</td><td>731</td><td>759</td><td>793</td><td>851</td><td>906</td><td>939</td><td>816</td><td>841</td><td>871</td> </tr> </tbody> </table>	A	B/COM	C	D	E	F	G	L3/COL	L4	L5	706	731	759	793	851	906	939	816	841	871	1260	ST30	MESH BACK & UPHOLSTERED SEAT 30" BAR STOOL - US Use for work surfaces up to 42" high	A00	<table border="1"> <thead> <tr> <th>A</th><th>B/COM</th><th>C</th><th>D</th><th>E</th><th>F</th><th>G</th><th>L3/COL</th><th>L4</th><th>L5</th> </tr> </thead> <tbody> <tr> <td>661</td><td>686</td><td>714</td><td>748</td><td>806</td><td>861</td><td>894</td><td>771</td><td>796</td><td>826</td> </tr> </tbody> </table>	A	B/COM	C	D	E	F	G	L3/COL	L4	L5	661	686	714	748	806	861	894	771	796	826	<ul style="list-style-type: none"> • All mesh styles available M1, M2, M3, M4 • Bar height stool • Non-marring floor glides • Foot rest 	<table border="1"> <thead> <tr> <th>WIDTH:</th><td>22.0</td><td>25.5</td> </tr> <tr> <th>DEPTH:</th><td>25.0</td><td>25.0</td> </tr> <tr> <th>HEIGHT:</th><td>42.0</td><td>42.0</td> </tr> <tr> <th>SEAT WIDTH:</th><td>19.5</td><td>19.5</td> </tr> <tr> <th>SEAT DEPTH:</th><td>17.0</td><td>17.0</td> </tr> <tr> <th>SEAT HEIGHT:</th><td>27.0</td><td>27.0</td> </tr> <tr> <th>BACK WIDTH:</th><td>20.0</td><td>20.0</td> </tr> <tr> <th>BACK HEIGHT:</th><td>16.0</td><td>16.0</td> </tr> <tr> <th>COM:</th><td>0.8 YD</td><td>0.8 YD</td> </tr> <tr> <th>WEIGHT:</th><td>25.5 LB</td><td>28.5 LB</td> </tr> </thead></table>	WIDTH:	22.0	25.5	DEPTH:	25.0	25.0	HEIGHT:	42.0	42.0	SEAT WIDTH:	19.5	19.5	SEAT DEPTH:	17.0	17.0	SEAT HEIGHT:	27.0	27.0	BACK WIDTH:	20.0	20.0	BACK HEIGHT:	16.0	16.0	COM:	0.8 YD	0.8 YD	WEIGHT:	25.5 LB	28.5 LB	M1 MESH NC M2, M3, M4 \$30		A18B/G	<table border="1"> <thead> <tr> <th>A</th><th>B/COM</th><th>C</th><th>D</th><th>E</th><th>F</th><th>G</th><th>L3/COL</th><th>L4</th><th>L5</th> </tr> </thead> <tbody> <tr> <td>726</td><td>751</td><td>779</td><td>813</td><td>871</td><td>926</td><td>959</td><td>836</td><td>861</td><td>891</td> </tr> </tbody> </table>	A	B/COM	C	D	E	F	G	L3/COL	L4	L5	726	751	779	813	871	926	959	836	861	891																																																																																			
A	B/COM	C	D	E	F	G	L3/COL	L4	L5																																																																																																																																																																																																																																																																		
661	686	714	748	806	861	894	771	796	826																																																																																																																																																																																																																																																																		
1260	ST27	MESH BACK & UPHOLSTERED SEAT 27" COUNTER STOOL - US Use for work surfaces up to 36" high	A00	<table border="1"> <thead> <tr> <th>A</th><th>B/COM</th><th>C</th><th>D</th><th>E</th><th>F</th><th>G</th><th>L3/COL</th><th>L4</th><th>L5</th> </tr> </thead> <tbody> <tr> <td>641</td><td>666</td><td>694</td><td>728</td><td>786</td><td>841</td><td>874</td><td>751</td><td>776</td><td>806</td> </tr> </tbody> </table>	A	B/COM	C	D	E	F	G	L3/COL	L4	L5	641	666	694	728	786	841	874	751	776	806	<ul style="list-style-type: none"> • All mesh styles available M1, M2, M3, M4 • Counter height stool • Non-marring floor glides • Foot rest 	<table border="1"> <thead> <tr> <th>WIDTH:</th><td>22.0</td><td>25.5</td> </tr> <tr> <th>DEPTH:</th><td>25.0</td><td>25.0</td> </tr> <tr> <th>HEIGHT:</th><td>39.0</td><td>39.0</td> </tr> <tr> <th>SEAT WIDTH:</th><td>19.5</td><td>19.5</td> </tr> <tr> <th>SEAT DEPTH:</th><td>17.0</td><td>17.0</td> </tr> <tr> <th>SEAT HEIGHT:</th><td>27.0</td><td>27.0</td> </tr> <tr> <th>BACK WIDTH:</th><td>20.0</td><td>20.0</td> </tr> <tr> <th>BACK HEIGHT:</th><td>16.0</td><td>16.0</td> </tr> <tr> <th>COM:</th><td>0.8 YD</td><td>0.8 YD</td> </tr> <tr> <th>WEIGHT:</th><td>25.0 LB</td><td>28.0 LB</td> </tr> </thead></table>	WIDTH:	22.0	25.5	DEPTH:	25.0	25.0	HEIGHT:	39.0	39.0	SEAT WIDTH:	19.5	19.5	SEAT DEPTH:	17.0	17.0	SEAT HEIGHT:	27.0	27.0	BACK WIDTH:	20.0	20.0	BACK HEIGHT:	16.0	16.0	COM:	0.8 YD	0.8 YD	WEIGHT:	25.0 LB	28.0 LB	M1 MESH NC M2, M3, M4 \$30																																																																																																																																																																																																																		
	A		B/COM	C	D	E	F	G	L3/COL	L4	L5																																																																																																																																																																																																																																																																
641	666	694	728	786	841	874	751	776	806																																																																																																																																																																																																																																																																		
WIDTH:	22.0	25.5																																																																																																																																																																																																																																																																									
DEPTH:	25.0	25.0																																																																																																																																																																																																																																																																									
HEIGHT:	39.0	39.0																																																																																																																																																																																																																																																																									
SEAT WIDTH:	19.5	19.5																																																																																																																																																																																																																																																																									
SEAT DEPTH:	17.0	17.0																																																																																																																																																																																																																																																																									
SEAT HEIGHT:	27.0	27.0																																																																																																																																																																																																																																																																									
BACK WIDTH:	20.0	20.0																																																																																																																																																																																																																																																																									
BACK HEIGHT:	16.0	16.0																																																																																																																																																																																																																																																																									
COM:	0.8 YD	0.8 YD																																																																																																																																																																																																																																																																									
WEIGHT:	25.0 LB	28.0 LB																																																																																																																																																																																																																																																																									
	A18B/G	<table border="1"> <thead> <tr> <th>A</th><th>B/COM</th><th>C</th><th>D</th><th>E</th><th>F</th><th>G</th><th>L3/COL</th><th>L4</th><th>L5</th> </tr> </thead> <tbody> <tr> <td>706</td><td>731</td><td>759</td><td>793</td><td>851</td><td>906</td><td>939</td><td>816</td><td>841</td><td>871</td> </tr> </tbody> </table>	A	B/COM	C	D	E	F	G	L3/COL	L4	L5	706	731	759	793	851	906	939	816	841	871	1260	ST30	MESH BACK & UPHOLSTERED SEAT 30" BAR STOOL - US Use for work surfaces up to 42" high	A00	<table border="1"> <thead> <tr> <th>A</th><th>B/COM</th><th>C</th><th>D</th><th>E</th><th>F</th><th>G</th><th>L3/COL</th><th>L4</th><th>L5</th> </tr> </thead> <tbody> <tr> <td>661</td><td>686</td><td>714</td><td>748</td><td>806</td><td>861</td><td>894</td><td>771</td><td>796</td><td>826</td> </tr> </tbody> </table>	A	B/COM	C	D	E	F	G	L3/COL	L4	L5	661	686	714	748	806	861	894	771	796	826	<ul style="list-style-type: none"> • All mesh styles available M1, M2, M3, M4 • Bar height stool • Non-marring floor glides • Foot rest 	<table border="1"> <thead> <tr> <th>WIDTH:</th><td>22.0</td><td>25.5</td> </tr> <tr> <th>DEPTH:</th><td>25.0</td><td>25.0</td> </tr> <tr> <th>HEIGHT:</th><td>42.0</td><td>42.0</td> </tr> <tr> <th>SEAT WIDTH:</th><td>19.5</td><td>19.5</td> </tr> <tr> <th>SEAT DEPTH:</th><td>17.0</td><td>17.0</td> </tr> <tr> <th>SEAT HEIGHT:</th><td>27.0</td><td>27.0</td> </tr> <tr> <th>BACK WIDTH:</th><td>20.0</td><td>20.0</td> </tr> <tr> <th>BACK HEIGHT:</th><td>16.0</td><td>16.0</td> </tr> <tr> <th>COM:</th><td>0.8 YD</td><td>0.8 YD</td> </tr> <tr> <th>WEIGHT:</th><td>25.5 LB</td><td>28.5 LB</td> </tr> </thead></table>	WIDTH:	22.0	25.5	DEPTH:	25.0	25.0	HEIGHT:	42.0	42.0	SEAT WIDTH:	19.5	19.5	SEAT DEPTH:	17.0	17.0	SEAT HEIGHT:	27.0	27.0	BACK WIDTH:	20.0	20.0	BACK HEIGHT:	16.0	16.0	COM:	0.8 YD	0.8 YD	WEIGHT:	25.5 LB	28.5 LB	M1 MESH NC M2, M3, M4 \$30		A18B/G	<table border="1"> <thead> <tr> <th>A</th><th>B/COM</th><th>C</th><th>D</th><th>E</th><th>F</th><th>G</th><th>L3/COL</th><th>L4</th><th>L5</th> </tr> </thead> <tbody> <tr> <td>726</td><td>751</td><td>779</td><td>813</td><td>871</td><td>926</td><td>959</td><td>836</td><td>861</td><td>891</td> </tr> </tbody> </table>	A	B/COM	C	D	E	F	G	L3/COL	L4	L5	726	751	779	813	871	926	959	836	861	891																																																																																																																																																																				
A	B/COM	C	D	E	F	G	L3/COL	L4	L5																																																																																																																																																																																																																																																																		
706	731	759	793	851	906	939	816	841	871																																																																																																																																																																																																																																																																		
1260	ST30	MESH BACK & UPHOLSTERED SEAT 30" BAR STOOL - US Use for work surfaces up to 42" high	A00	<table border="1"> <thead> <tr> <th>A</th><th>B/COM</th><th>C</th><th>D</th><th>E</th><th>F</th><th>G</th><th>L3/COL</th><th>L4</th><th>L5</th> </tr> </thead> <tbody> <tr> <td>661</td><td>686</td><td>714</td><td>748</td><td>806</td><td>861</td><td>894</td><td>771</td><td>796</td><td>826</td> </tr> </tbody> </table>	A	B/COM	C	D	E	F	G	L3/COL	L4	L5	661	686	714	748	806	861	894	771	796	826	<ul style="list-style-type: none"> • All mesh styles available M1, M2, M3, M4 • Bar height stool • Non-marring floor glides • Foot rest 	<table border="1"> <thead> <tr> <th>WIDTH:</th><td>22.0</td><td>25.5</td> </tr> <tr> <th>DEPTH:</th><td>25.0</td><td>25.0</td> </tr> <tr> <th>HEIGHT:</th><td>42.0</td><td>42.0</td> </tr> <tr> <th>SEAT WIDTH:</th><td>19.5</td><td>19.5</td> </tr> <tr> <th>SEAT DEPTH:</th><td>17.0</td><td>17.0</td> </tr> <tr> <th>SEAT HEIGHT:</th><td>27.0</td><td>27.0</td> </tr> <tr> <th>BACK WIDTH:</th><td>20.0</td><td>20.0</td> </tr> <tr> <th>BACK HEIGHT:</th><td>16.0</td><td>16.0</td> </tr> <tr> <th>COM:</th><td>0.8 YD</td><td>0.8 YD</td> </tr> <tr> <th>WEIGHT:</th><td>25.5 LB</td><td>28.5 LB</td> </tr> </thead></table>	WIDTH:	22.0	25.5	DEPTH:	25.0	25.0	HEIGHT:	42.0	42.0	SEAT WIDTH:	19.5	19.5	SEAT DEPTH:	17.0	17.0	SEAT HEIGHT:	27.0	27.0	BACK WIDTH:	20.0	20.0	BACK HEIGHT:	16.0	16.0	COM:	0.8 YD	0.8 YD	WEIGHT:	25.5 LB	28.5 LB	M1 MESH NC M2, M3, M4 \$30																																																																																																																																																																																																																		
	A		B/COM	C	D	E	F	G	L3/COL	L4	L5																																																																																																																																																																																																																																																																
661	686	714	748	806	861	894	771	796	826																																																																																																																																																																																																																																																																		
WIDTH:	22.0	25.5																																																																																																																																																																																																																																																																									
DEPTH:	25.0	25.0																																																																																																																																																																																																																																																																									
HEIGHT:	42.0	42.0																																																																																																																																																																																																																																																																									
SEAT WIDTH:	19.5	19.5																																																																																																																																																																																																																																																																									
SEAT DEPTH:	17.0	17.0																																																																																																																																																																																																																																																																									
SEAT HEIGHT:	27.0	27.0																																																																																																																																																																																																																																																																									
BACK WIDTH:	20.0	20.0																																																																																																																																																																																																																																																																									
BACK HEIGHT:	16.0	16.0																																																																																																																																																																																																																																																																									
COM:	0.8 YD	0.8 YD																																																																																																																																																																																																																																																																									
WEIGHT:	25.5 LB	28.5 LB																																																																																																																																																																																																																																																																									
	A18B/G	<table border="1"> <thead> <tr> <th>A</th><th>B/COM</th><th>C</th><th>D</th><th>E</th><th>F</th><th>G</th><th>L3/COL</th><th>L4</th><th>L5</th> </tr> </thead> <tbody> <tr> <td>726</td><td>751</td><td>779</td><td>813</td><td>871</td><td>926</td><td>959</td><td>836</td><td>861</td><td>891</td> </tr> </tbody> </table>	A	B/COM	C	D	E	F	G	L3/COL	L4	L5	726	751	779	813	871	926	959	836	861	891																																																																																																																																																																																																																																																					
A	B/COM	C	D	E	F	G	L3/COL	L4	L5																																																																																																																																																																																																																																																																		
726	751	779	813	871	926	959	836	861	891																																																																																																																																																																																																																																																																		

CAUTION: Careless stacking of chairs may scratch and damage frames. Due to the nature of vinyl upholstery, stacking may cause impressions on the seat. 9to5 Seating does not warrant the effects of the stacking on vinyl upholstery.

(BACK)

shuttle

the ultimate utility chair

GSA SIN # 33721

- Multipurpose seating, including stacking, side, stools and bariatric
- All plastic, upholstered seat or fully upholstered
- Wall-saver frame on select models
- Plastic back and upholstered back models warranted to 350 lbs., mesh back to 300 lbs., bariatric to 600 lbs.



UPHOLSTERED SEAT - US - SLED

CREATING SHUTTLE MODEL NUMBER

MODEL NUMBER CONTROL ARMS FRAME COLOR UPHOLSTERY MESH COLOR PLASTIC COLOR GRADE PACKAGING OPTIONS

1 2 - GT - A - F - U - S - M - P - - - -

* FOR ARMLESS USE CODE A00

PACKAGING NOTES

CODE	DESCRIPTION	LIST UPCHARGE
AB	ASSEMBLED IN BAG	\$0
AC	ASSEMBLED IN CARTON	\$0

SLED BASE CHAIRS SHIP 2 ARMLESS PER CARTON, 1 WITH ARMS

MODEL	CONTROL	DESCRIPTION	ARM	FABRIC											FEATURES	DIMENSIONS	
				A	B/COM	C	D	E	F	G	L3/COL	L4	L5	ARMLESS		W/ ARMS	
1230	GT	PLASTIC BACK & UPHOLSTERED SEAT SLED BASE GUEST - US	A00	521	546	574	608	666	721	754	631	656	686	<ul style="list-style-type: none"> • Non-marring floor glides • Wall-saver frame 	WIDTH:	22.0	25.5
			A18B/G	586	611	639	673	731	786	819	696	721	751		DEPTH:	25.0	25.0
1280	GT	MESH BACK & UPHOLSTERED SEAT SLED BASE GUEST - US	A00	586	611	639	673	731	786	819	696	721	751	<ul style="list-style-type: none"> • All mesh styles available M1, M2, M3, M4 • Non-marring floor glides • Wall-saver frame 	HEIGHT:	33.0	33.0
			A18B/G	651	676	704	738	796	851	884	761	786	816		SEAT WIDTH:	19.5	19.5
														SEAT DEPTH:	17.0	17.0	
														SEAT HEIGHT:	17.0	17.0	
														BACK WIDTH:	20.0	20.0	
														BACK HEIGHT:	16.0	16.0	
														COM:	1.2 YD	1.2 YD	
														WEIGHT:	21.0 LB	24.0 LB	

ARM OPTIONS

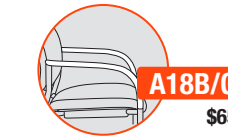

A18B/G
\$65
Soft Touch Polyurethane Arm
A18B - Black
A18G - Gray

ADDITIONAL OPTIONS

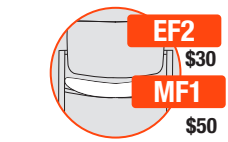

EF2 \$30
MF1 \$50
EF2 - 2" Extra Foam on Seat
MF1 - 1" Visco Elastic Memory Foam on Seat

FRAME COLORS

BLACK BF	SILVER SF
-------------	--------------

MESH COLORS

M1	BLACK M11	GRAY M12	SILVER M13			
M2	BLACK M21	GRAY M22	WHITE M23	GREEN M24	RED M25	
M2	BLUE M26	ORANGE M27	AQUA M28			
M3	GRAPHITE M31	SLATE M32	SNOW M33			
M4	LATTE M40	CLOUD M41	LEMON M42	APPLE M43	TANGERINE M44	CRIMSON M46
M4	ONYX M48	DOVE M49	AZURE M50	FEDERAL BLUE M51	WHITE WHISPER M52	

M1 MESH NC **M2, M3, M4** \$30

PLASTIC COLORS

BLACK SWAN P01	WHITE WHISPER P05	FEDERAL BLUE P11	CRIMSON RED P12	LEMON YELLOW P13	DOVE GRAY P14
CLOUD GRAY P15	LAGOON BLUE P16	APPLE GREEN P17	TANGERINE ORANGE P18	LATTE P19	AZURE BLUE P20

(BACK & SEAT)

CAUTION: Careless stacking of chairs may scratch and damage frames. Due to the nature of vinyl upholstery, stacking may cause impressions on the seat. 9to5 Seating does not warrant the effects of the stacking on vinyl upholstery.

shuttle

the ultimate utility chair

GSA SIN # 33721

- Multipurpose seating, including stacking, side, stools and bariatric
- All plastic, upholstered seat or fully upholstered
- Wall-saver frame on select models
- Plastic back and upholstered back models warranted to 350 lbs., bariatric to 600 lbs.



FULLY UPHOLSTERED - UP - GUEST

CREATING SHUTTLE MODEL NUMBER



PACKAGING NOTES

CODE	DESCRIPTION	LIST UPCHARGE
AB	ASSEMBLED IN BAG	\$0
AC	ASSEMBLED IN CARTON	\$0

SHUTTLE SIDE CHAIRS SHIP UP TO 3 PER CARTON (WITH TLF/TRF UP TO 2 PER CARTON)

MODEL	CONTROL	DESCRIPTION	ARM	FABRIC	DIMENSIONS									
					A	B/COM	C	D	E	F	G	L3/COL	L4	L5
1210	GT	UPHOLSTERED BACK & UPHOLSTERED SEAT GUEST STACKING - UP	A00		476	516	551	611	671	756	811	756	806	926
			A18B/G		541	581	616	676	736	821	876	821	871	991
			TRF		651	691	726	786	846	931	986	931	981	1101

MODEL	CONTROL	DESCRIPTION	ARM	FABRIC	DIMENSIONS									
					A	B/COM	C	D	E	F	G	L3/COL	L4	L5
1215	GT	UPHOLSTERED BACK & UPHOLSTERED SEAT GUEST STACKING WITH CASTERS - UP	A00		521	561	596	656	716	801	856	801	851	971
			A18B/G		586	626	661	721	781	866	921	866	916	1036

- #### FEATURES
- Non-marring floor glides
 - Stacks 4 high on floor
 - Stacks 6 high on optional dolly
 - Wall-saver frame

DIMENSIONS

	ARMLESS	W/ ARMS
WIDTH:	22.0	25.5
DEPTH:	25.0	25.0
HEIGHT:	33.0	33.0
SEAT WIDTH:	19.5	19.5
SEAT DEPTH:	17.0	17.0
SEAT HEIGHT:	17.7	17.7
BACK WIDTH:	20.0	20.0
BACK HEIGHT:	16.0	16.0
COM:	1.2 YD	1.2 YD
WEIGHT:	21.0 LB	24.0 LB

- 50mm hooded casters
- Stacks 4 high on floor
- Stacks 6 high on optional dolly

	ARMLESS	W/ ARMS
WIDTH:	22.0	25.5
DEPTH:	25.0	25.0
HEIGHT:	33.0	33.0
SEAT WIDTH:	19.5	19.5
SEAT DEPTH:	17.0	17.0
SEAT HEIGHT:	17.0	17.0
BACK WIDTH:	20.0	20.0
BACK HEIGHT:	16.0	16.0
COM:	1.2 YD	1.2 YD
WEIGHT:	21.0 LB	24.0 LB

ARM OPTIONS

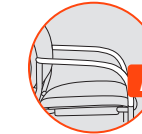

A18B/G
\$65
Soft Touch Polyurethane Arm
A18B - Black
A18G - Gray

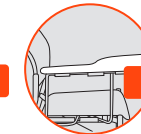

TRF
\$175
Right Tablet Arm (Available with Black Frame Only)
Tablet size: 12.5" x 23.25" x .75"

ADDITIONAL OPTIONS



G18
STD

Dome Glide



G8
\$20

Swivel Steel Glide
4 per Set



G9
\$20

Swivel Nylon Glide
4 per Set



G10
\$20

Swivel Felt Glide
4 per Set

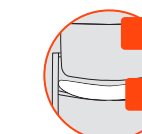

EF2
\$30
MF1
\$50
EF2 - 2" Extra Foam on Seat
MF1 - 1" Visco Elastic Memory Foam on Seat

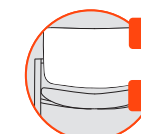

BN1
\$35
BN2
\$0
Black Ballistic Nylon Back
BN1 w/ Grade A Fabrics
BN2 w/ Grade B and Up

CASTER OPTIONS



C5
STD
Carpet Casters

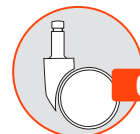

C5S
\$30
Hard Floor and Carpet Casters

ACCESSORIES



DL5
\$399
Stacking Dolly
Stacks Chairs 10 High Four Legs Only



GC1
\$30
GC2
\$30
Ganging Clip - 2 per Set
GC1 - Armless-to-Armless
GC2 - Arm-to-Arm



BRK
\$70
Book Rack in Black Only
Available on All Models
*Not Stackable with BRK

FRAME COLORS

BLACK BF	SILVER SF
-------------	--------------

CAUTION: Careless stacking of chairs may scratch and damage frames. Due to the nature of vinyl upholstery, stacking may cause impressions on the seat. 9to5 Seating does not warrant the effects of the stacking on vinyl upholstery.

shuttle

the ultimate utility chair

GSA SIN # 33721

- Multipurpose seating, including stacking, side, stools and bariatric
- All plastic, upholstered seat or fully upholstered
- Wall-saver frame on select models
- Plastic back and upholstered back models warranted to 350 lbs., bariatric to 600 lb



FULLY UPHOLSTERED - UP - STOOLS

CREATING SHUTTLE MODEL NUMBER

MODEL NUMBER CONTROL ARMS FRAME COLOR UPHOLSTERY GRADE PACKAGING OPTIONS

1 2 - G T - A - F - U P - - - -

* FOR ARMLESS USE CODE A00

PACKAGING NOTES

CODE	DESCRIPTION	LIST UPCHARGE
AB	ASSEMBLED IN BAG	\$0
AC	ASSEMBLED IN CARTON	\$0

SHUTTLE STOOLS SHIP 1 PER CARTON

MODEL	CONTROL	DESCRIPTION	ARM	FABRIC	DIMENSIONS										
					A	B/COM	C	D	E	F	G	L3/COL	L4	L5	
1210	ST27	UPHOLSTERED BACK & UPHOLSTERED SEAT 27" COUNTER STOOL - UP Use for work surfaces up to 36" high	A00		606	646	681	741	801	886	941	886	936	1056	
			A18B/G		671	711	746	806	866	951	1006	951	1001	1121	

MODEL	CONTROL	DESCRIPTION	ARM	FABRIC	DIMENSIONS										
					A	B/COM	C	D	E	F	G	L3/COL	L4	L5	
1210	ST30	UPHOLSTERED BACK & UPHOLSTERED SEAT 30" BAR STOOL - UP Use for work surfaces up to 42" high	A00		626	666	701	761	821	906	961	906	956	1076	
			A18B/G		691	731	766	826	886	971	1026	971	1021	1141	

FEATURES

- Counter height stool
- Non-marring floor glides
- Foot rest

DIMENSIONS

	ARMLESS	W/ ARMS
WIDTH:	22.0	25.5
DEPTH:	25.0	25.0
HEIGHT:	42.0	42.0
SEAT WIDTH:	19.5	19.5
SEAT DEPTH:	17.0	17.0
SEAT HEIGHT:	27.0	27.0
BACK WIDTH:	20.0	20.0
BACK HEIGHT:	16.0	16.0
COM:	1.2 YD	1.2 YD
WEIGHT:	26.0 LB	29.0 LB

- Bar height stool
- Non-marring floor glides
- Foot rest

WIDTH:	22.0	25.5
DEPTH:	25.0	25.0
HEIGHT:	45.0	45.0
SEAT WIDTH:	19.5	19.5
SEAT DEPTH:	17.0	17.0
SEAT HEIGHT:	30.0	30.0
BACK WIDTH:	20.0	20.0
BACK HEIGHT:	16.0	16.0
COM:	1.2 YD	1.2 YD
WEIGHT:	26.5 LB	29.5 LB

ARM OPTIONS

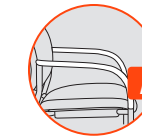

A18B/G
\$65

Soft Touch Polyurethane Arm
A18B - Black
A18G - Gray

ADDITIONAL OPTIONS

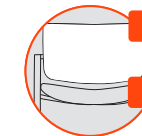

BN1
\$35
BN2
\$0

Black Ballistic Nylon Back
BN1 w/ Grade A Fabrics
BN2 w/ Grade B and Up

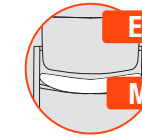

EF2
\$30
MF1
\$50

EF2 - 2" Extra Foam on Seat
MF1 - 1" Visco Elastic Memory Foam on Seat



GC1
\$30
GC2
\$30

Ganging Clip - 2 per Set
GC1 - Armless-to-Armless
GC2 - Arm-to-Arm

FRAME COLORS

BLACK BF	SILVER SF
-------------	--------------

CAUTION: Careless stacking of chairs may scratch and damage frames. Due to the nature of vinyl upholstery, stacking may cause impressions on the seat. 9to5 Seating does not warrant the effects of the stacking on vinyl upholstery.

shuttle

the ultimate utility chair

GSA SIN # 33721

- Multipurpose seating, including stacking, side, stools and bariatric
- All plastic, upholstered seat or fully upholstered
- Wall-saver frame on select models
- Plastic back and upholstered back models warranted to 350 lbs., bariatric to 600 lb



FULLY UPHOLSTERED - UP - SLED

CREATING SHUTTLE MODEL NUMBER

MODEL NUMBER CONTROL ARMS FRAME COLOR UPHOLSTERY GRADE PACKAGING OPTIONS

1 2 3 0 - G T - A [] [] [] - [] F - U P - [] [] [] [] [] []

* FOR ARMLESS USE CODE A00

PACKAGING NOTES

CODE	DESCRIPTION	LIST UPCHARGE
AB	ASSEMBLED IN BAG	\$0
AC	ASSEMBLED IN CARTON	\$0

SLED BASE CHAIRS SHIP 2 ARMLESS PER CARTON, 1 WITH ARMS

MODEL	CONTROL	DESCRIPTION	ARM	FABRIC	DIMENSIONS												
					A	B/COM	C	D	E	F	G	L3/COL	L4	L5			
1230	GT	UPHOLSTERED BACK & UPHOLSTERED SEAT SLED BASE GUEST - UP	A00		576	616	651	711	771	856	911	856	906	1026			
			A18B/G		641	681	716	776	836	921	976	921	971	1091			

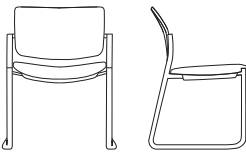

FEATURES

- Non-marring floor glides
- Wall-saver frame

DIMENSIONS

	ARMLESS	W/ ARMS
WIDTH:	22.0	25.5
DEPTH:	25.0	25.0
HEIGHT:	33.0	33.0
SEAT WIDTH:	19.5	19.5
SEAT DEPTH:	17.0	17.0
SEAT HEIGHT:	19.0	19.0
BACK WIDTH:	20.0	20.0
BACK HEIGHT:	16.0	16.0
COM:	1.2 YD	1.2 YD
WEIGHT:	24.0 LB	27.0 LB

ARM OPTIONS

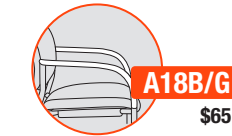

A18B/G
\$65

Soft Touch Polyurethane Arm
A18B - Black
A18G - Gray

ADDITIONAL OPTIONS

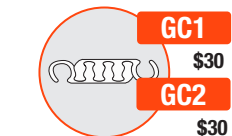

GC1 \$30
GC2 \$30

Ganging Clip - 2 per Set
GC1 - Armless-to-Armless
GC2 - Arm-to-Arm

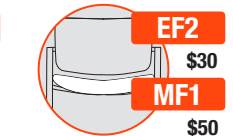

EF2 \$30
MF1 \$50

EF2 - 2" Extra Foam on Seat
MF1 - 1" Visco Elastic Memory Foam on Seat

FRAME COLORS

BLACK BF	SILVER SF
-------------	--------------

CAUTION: Careless stacking of chairs may scratch and damage frames. Due to the nature of vinyl upholstery, stacking may cause impressions on the seat. 9to5 Seating does not warrant the effects of the stacking on vinyl upholstery.

shuttle

the ultimate utility chair

GSA SIN # 33721

- Multipurpose seating, including stacking, side, stools and bariatric
- All plastic, upholstered seat or fully upholstered
- Wall-saver frame on select models
- Plastic back and upholstered back models warranted to 350 lbs., bariatric to 600 lbs.



BARIATRIC

CREATING SHUTTLE MODEL NUMBER

MODEL NUMBER	CONTROL	ARMS	FRAME COLOR	UPHOLSTERY	GRADE	PACKAGING	OPTIONS
1250	GT	A18	F	UP			

PACKAGING NOTES

CODE	DESCRIPTION	LIST UPCHARGE
AB	ASSEMBLED IN BAG	\$0
AC	ASSEMBLED IN CARTON	\$0

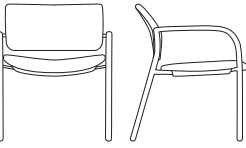
MODEL	CONTROL	DESCRIPTION	ARM	FABRIC							FEATURES	DIMENSIONS
				A	B/COM	C	D	E	F	G		
1250	GT	 <p>UPHOLSTERED BACK & UPHOLSTERED SEAT BARIATRIC - RATED TO 600 LBS.</p>	A18B/G	972	1042	1087	1157	1237	1327	1427	<ul style="list-style-type: none"> • Steel reinforced seat and back • 30" wide seat • Does not stack • Warranted to 600 lbs. 	WIDTH: 36.5 DEPTH: 25.0 HEIGHT: 33.0 SEAT WIDTH: 31.0 SEAT DEPTH: 17.0 SEAT HEIGHT: 19.0 BACK WIDTH: 30.0 BACK HEIGHT: 16.0 COM: 2.1 YD WEIGHT: 32.0 LB

ARM OPTIONS

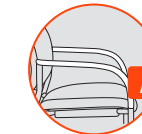

A18B/G
\$65

Soft Touch Polyurethane Arm
A18B - Black
A18G - Gray

ADDITIONAL OPTIONS



G18
STD

Dome Glide



G8
\$20

Swivel Steel Glide
4 per Set



G9
\$20

Swivel Nylon Glide
4 per Set



G10
\$20

Swivel Felt Glide
4 per Set

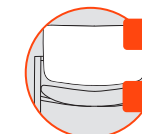

BN1
\$35
BN2
\$0

Black Ballistic Nylon Back
BN1 w/ Grade A Fabrics
BN2 w/ Grade B and Up



GC2
\$30

Ganging Clip - 2 per Set
GC2 - Arm-to-Arm

FRAME COLORS

BLACK BF	SILVER SF
-------------	--------------

sol
the future at a glance

GSA SIN # 33721

- Task, executive and conference seating
- Innovative design supports back, shoulders and arms without limiting range of motion
- Mesh or upholstered back options
- Integrated height-adjustable lumbar and seat slider standard
- Warranted to 300 lbs.



CREATING SOL MODEL NUMBER

MODEL NUMBER CONTROL ARMS FRAME PLASTIC COLOR MESH COLOR UPHOLSTERY GRADE BASE CASTERS PACKAGING
3 6 8 0 - Y 6 - A 4 8 P - F - P B K - M - B - B A 6 - C

PACKAGING NOTES

CODE	DESCRIPTION	LIST UPCHARGE
AB	ASSEMBLED IN BAG	\$0
BAC	BACK ASSEMBLED IN CARTON	\$0

MESH BACK (MB) & UPHOLSTERED BACK (UB)

MODEL	CONTROL	DESCRIPTION	ARM	FABRIC/LEATHER																	
				A	B/COM	C	D	E	F	G	L3/COL	L4	L5								
3680	Y6	MESH BACK - MB DELUXE SYNCHRO	A48P	1423	1453	1483	1533	1583	1633	1698	1623	1623	1773								

MODEL	CONTROL	DESCRIPTION	ARM	FABRIC/LEATHER																	
				A	B/COM	C	D	E	F	G	L3/COL	L4	L5								
3680	Y6	UPHOLSTERED BACK - UB DELUXE SYNCHRO	A48P	1495	1575	1630	1705	1805	1905	2020	1730	1810	2090								

FEATURES

- Integrated seat slider
- 4-position tilt lock
- Side knob tension adjustment with 7 settings
- 2:1 back-to-seat tilt ratio
- 360° swivel
- Pneumatic cylinder height adjustment

DIMENSIONS

WIDTH: 28.0
 DEPTH: 28.0
 HEIGHT: 39.5-44.0
 SEAT WIDTH: 19.0
 SEAT DEPTH: 16.5-19.0
 SEAT HEIGHT: 16.5-21.0
 BACK WIDTH: 18.5
 BACK HEIGHT: 25.0
 COM: 0.9 YD
 COL: 16.0 SQ FT
 WEIGHT: 50.0 LB

FEATURES

- Integrated seat slider
- 4-position tilt lock
- Side knob tension adjustment with 7 settings
- 2:1 back-to-seat tilt ratio
- 360° swivel
- Pneumatic cylinder height adjustment

DIMENSIONS

WIDTH: 28.0
 DEPTH: 28.0
 HEIGHT: 39.5-44.0
 SEAT WIDTH: 19.0
 SEAT DEPTH: 16.5-19.0
 SEAT HEIGHT: 16.5-21.0
 BACK WIDTH: 18.5
 BACK HEIGHT: 25.0
 COM: 2.2 YD
 COL: 32.0 SQ FT
 WEIGHT: 50.0 LB

ARM OPTIONS

A48P STD
 6-Way Height-Adjustable Arm w/ Sliding Pad
 A48P - Polished

BASE OPTIONS

BA26B STD
 27" Low Profile Nylon Base
 BA26B - Black

BA36P/S STD
 27" Low Profile Aluminum Base
 P - Polished
 S - Silver Powder Coat

FRAME COLORS*

POLISHED PF	SILVER SF
-------------	-----------

*BOTH PF AND SF COME WITH POLISHED ALUMINUM ARMS.

MESH COLORS

M2	BLACK M21	GRAY M22	WHITE M23	GREEN M24
M2	RED M25	BLUE M26	ORANGE M27	AQUA M28

M4	LATTE M40	CLOUD M41	LEMON M42	APPLE M43	TANGERINE M44	CRIMSON M46
M4	ONYX M48	DOVE M49	AZURE M50	FEDERAL BLUE M51	WHITE WHISPER M52	

CASTER OPTIONS

C6 STD
 Large Diameter Carpet Casters

C6S \$35
 Large Diameter Hard Floor and Carpet Casters

C7 STD
 Chrome-Accented Hard Floor and Carpet Casters

sophie

ultimate comfort in a complete line of lounge seating

LOUNGE

GSA SIN # 33721

- Lounge collection, including guest, multi-seat, bariatric, hip, bench and tables
- Robust steel frame construction for high-traffic areas
- Cleanout space and wall-saver frame on selected models
- Field replaceable parts and arm caps
- Silver and black frame finishes
- Warranted to 350+ lbs.



CREATING SOPHIE MODEL NUMBER

MODEL NUMBER CONTROL ARMS FRAME COLOR GRADE PACKAGING OPTIONS
8 1 1 - **GT** - **A 8 0** - **F** - **AC** -

MODEL	CONTROL	DESCRIPTION	ARM	FABRIC/LEATHER										FEATURES	DIMENSIONS	
				A	B/COM	C	D	E	F	G	L3/COL	L4	L5			
8111	GT	SINGLE GUEST	A80B/G	1191	1251	1326	1406	1506	1586	1716	1541	1666	1866	<ul style="list-style-type: none"> • Wall-saver frame • Soft-touch urethane arm pads • Non-marring adjustable glides • Warranted to 350 lbs. 	WIDTH: 25.0 DEPTH: 27.5 HEIGHT: 34.0 SEAT WIDTH: 20.0 SEAT DEPTH: 19.0 SEAT HEIGHT: 18.0 BACK WIDTH: 20.0 BACK HEIGHT: 19.0 COM: 1.7 YD COL: 35.0 SQ FT WEIGHT: 56.0 LB	
8119	GT	BARIATRIC	A80B/G	1491	1586	1686	1791	1956	2096	2191	1841	2166	2401	<ul style="list-style-type: none"> • Wall-saver frame • Soft-touch urethane arm pads • Non-marring adjustable glides • Warranted to 500 lbs. 	WIDTH: 35.0 DEPTH: 27.5 HEIGHT: 34.0 SEAT WIDTH: 30.0 SEAT DEPTH: 19.0 SEAT HEIGHT: 18.0 BACK WIDTH: 29.0 BACK HEIGHT: 19.0 COM: 2.7 YD COL: 40.0 SQ FT WEIGHT: 66.0 LB	

ARM OPTIONS

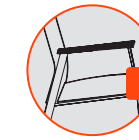

A80B

Soft Touch Pad - Black



A80G

Soft Touch Pad - Gray

FRAME COLORS



ADDITIONAL OPTIONS

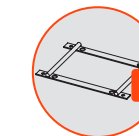

8199

\$99

Large Ganging Bracket

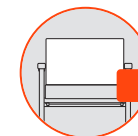

TT

\$100*

Two Tone Contrasting Upholstery (seat and back)

* If the two upholstery selections are of different grades, the chair will price at the higher of the two grades.

sophie

ultimate comfort in a complete line of lounge seating

LOUNGE

GSA SIN # 33721

- Lounge collection, including guest, multi-seat, bariatric, hip, bench and tables
- Robust steel frame construction for high-traffic areas
- Cleanout space and wall-saver frame on selected models
- Field replaceable parts and arm caps
- Silver and black frame finishes
- Warranted to 350+ lbs.



CREATING SOPHIE MODEL NUMBER

MODEL NUMBER CONTROL ARMS FRAME COLOR GRADE PACKAGING OPTIONS
81 **GT** **A80** **F** **AC**

MODEL	CONTROL	DESCRIPTION	ARM	FABRIC	DIMENSIONS										FEATURES	DIMENSIONS
					A	B/COM	C	D	E	F	G	L3/COL	L4	L5		
8112	GT	DOUBLE SEAT W/ OUTSIDE ARMS	A80B/G		1716	1836	1956	2126	2296	2516	2766	2241	2566	3016	<ul style="list-style-type: none"> • Wall-saver frame • Outer armrests feature soft-touch urethane arm pads • Non-marring adjustable glides • Warranted to 525 lbs. 	WIDTH: 46.0 DEPTH: 27.5 HEIGHT: 34.0 SEAT WIDTH: 20.0 SEAT DEPTH: 19.0 SEAT HEIGHT: 18.0 BACK WIDTH: 20.0 BACK HEIGHT: 19.0 COM: 3.0 YD COL: 70.0 YD WEIGHT: 87.0 LB
8122	GT	DOUBLE SEAT W/ CENTER ARM	A80B/G		1826	1946	2066	2236	2406	2626	2876	2351	2676	3126	<ul style="list-style-type: none"> • Wall-saver frame • Outer and inner armrests feature soft-touch urethane arm pads • Non-marring adjustable glides • Warranted to 525 lbs. 	WIDTH: 47.5 DEPTH: 27.5 HEIGHT: 34.0 SEAT WIDTH: 20.5 SEAT DEPTH: 19.0 SEAT HEIGHT: 18.0 BACK WIDTH: 20.0 BACK HEIGHT: 19.0 COM: 3.0 YD COL: 70.0 YD WEIGHT: 95.0 LB
8123	GT	TRIPLE SEAT W/ CENTER ARMS	A80B/G		2526	2706	2886	3096	3366	3621	3936	3051	3651	4251	<ul style="list-style-type: none"> • Wall-saver frame • Outer and inner armrests feature soft-touch urethane arm pads • Non-marring adjustable glides • Warranted to 750 lbs. 	WIDTH: 70.0 DEPTH: 27.5 HEIGHT: 34.0 SEAT WIDTH: 20.5 SEAT DEPTH: 19.0 SEAT HEIGHT: 18.0 BACK WIDTH: 20.0 BACK HEIGHT: 19.0 COM: 4.4 YD COL: 105.0 YD WEIGHT: 136.0 LB

ARM OPTIONS

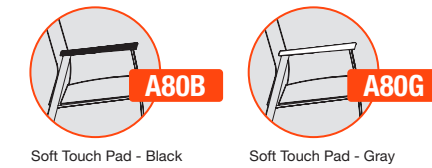

FRAME COLORS



ADDITIONAL OPTIONS



Please note, CAL TB 133 Fire Code option is charged per seat. Refer to page 14 for details.

sophie

ultimate comfort in a complete line of lounge seating

LOUNGE BENCHES

GSA SIN # 33721

- Lounge collection, including guest, multi-seat, bariatric, hip, bench and tables
- Robust steel frame construction for high-traffic areas
- Cleanout space and wall-saver frame on selected models
- Field replaceable parts and arm caps
- Silver and black frame finishes
- Warranted to 350+ lbs.



CREATING SOPHIE MODEL NUMBER

MODEL NUMBER CONTROL FRAME COLOR LAMINATE COLOR GRADE PACKAGING
810 - **GT** - **F** - **A** **C**

MODEL	CONTROL	DESCRIPTION	FABRIC	FEATURES	DIMENSIONS	FRAME COLORS	LAMINATE COLORS																																																							
8103	GT	TRIPLE BENCH	<table border="1"> <thead> <tr> <th>A</th> <th>B/COM</th> <th>C</th> <th>D</th> <th>E</th> <th>F</th> <th>G</th> <th>L3/COL</th> <th>L4</th> <th>L5</th> </tr> </thead> <tbody> <tr> <td>1908</td> <td>2018</td> <td>2118</td> <td>2253</td> <td>2408</td> <td>2533</td> <td>2678</td> <td>2493</td> <td>2608</td> <td>2908</td> </tr> <tr> <td></td> <td></td> <td></td> <td></td> <td></td> <td></td> <td></td> <td></td> <td></td> <td></td> </tr> <tr> <td></td> <td></td> <td></td> <td></td> <td></td> <td></td> <td></td> <td></td> <td></td> <td></td> </tr> <tr> <td></td> <td></td> <td></td> <td></td> <td></td> <td></td> <td></td> <td></td> <td></td> <td></td> </tr> </tbody> </table>	A	B/COM	C	D	E	F	G	L3/COL	L4	L5	1908	2018	2118	2253	2408	2533	2678	2493	2608	2908																															<ul style="list-style-type: none"> • Three-seat bench • Non-marring adjustable glides • Warranted to 750 lbs. 	<p>WIDTH: 61.5 DEPTH: 23.5 HEIGHT: 18.0 SEAT WIDTH: 20.5 SEAT DEPTH: 23.5 SEAT HEIGHT: 18.0 COM: 2.3 YD WEIGHT: 62.0 LB</p>	<table border="1"> <tr> <td>BLACK BF</td> <td>SILVER SF</td> </tr> </table>	BLACK BF	SILVER SF	<table border="1"> <tr> <td>BLACK BKL</td> <td>DESIGNER WHITE DWL</td> <td>PLATINUM PTL</td> </tr> </table>	BLACK BKL	DESIGNER WHITE DWL	PLATINUM PTL
A	B/COM	C	D	E	F	G	L3/COL	L4	L5																																																					
1908	2018	2118	2253	2408	2533	2678	2493	2608	2908																																																					
BLACK BF	SILVER SF																																																													
BLACK BKL	DESIGNER WHITE DWL	PLATINUM PTL																																																												
8104	GT	DOUBLE BENCH W/ TABLE TOP	<table border="1"> <thead> <tr> <th>A</th> <th>B/COM</th> <th>C</th> <th>D</th> <th>E</th> <th>F</th> <th>G</th> <th>L3/COL</th> <th>L4</th> <th>L5</th> </tr> </thead> <tbody> <tr> <td>1806</td> <td>1871</td> <td>1941</td> <td>2026</td> <td>2131</td> <td>2206</td> <td>2306</td> <td>2206</td> <td>2281</td> <td>2481</td> </tr> <tr> <td></td> <td></td> <td></td> <td></td> <td></td> <td></td> <td></td> <td></td> <td></td> <td></td> </tr> <tr> <td></td> <td></td> <td></td> <td></td> <td></td> <td></td> <td></td> <td></td> <td></td> <td></td> </tr> <tr> <td></td> <td></td> <td></td> <td></td> <td></td> <td></td> <td></td> <td></td> <td></td> <td></td> </tr> </tbody> </table>	A	B/COM	C	D	E	F	G	L3/COL	L4	L5	1806	1871	1941	2026	2131	2206	2306	2206	2281	2481																															<ul style="list-style-type: none"> • Two-seat bench with center tabletop • Non-marring adjustable glides • Warranted to 525 lbs. 	<p>WIDTH: 61.5 DEPTH: 23.5 HEIGHT: 18.0 SEAT WIDTH: 20.5 SEAT DEPTH: 23.5 SEAT HEIGHT: 18.0 COM: 1.8 YD WEIGHT: 62.0 LB</p>							
A	B/COM	C	D	E	F	G	L3/COL	L4	L5																																																					
1806	1871	1941	2026	2131	2206	2306	2206	2281	2481																																																					

Please note, CAL TB 133 Fire Code option is charged per seat. Refer to page 14 for details.

sophie

ultimate comfort in a complete line of lounge seating

GSA SIN # 33721



- Stand-alone and linking tables that complement Sophie seating
- Silver and black frame finishes
- Five laminate colors
- Tables ship knocked down (KD)



CREATING SOPHIE MODEL NUMBER

MODEL NUMBER CONTROL FRAME COLOR LAMINATE COLOR PACKAGING
8 1 - **T B** - **F** - **K D**

LOUNGE TABLES

MODEL	CONTROL	DESCRIPTION	TABLE	FEATURES	DIMENSIONS
8170 	TB	STAND-ALONE 22" X 42" RECTANGULAR	835	<ul style="list-style-type: none"> • Two stand-alone table sizes • Three laminate colors • Two frame colors 	WIDTH: 22.0 DEPTH: 42.0 HEIGHT: 17.0
8190 	TB	STAND-ALONE 24" SQUARE	692	<ul style="list-style-type: none"> • Two stand-alone table sizes • Three laminate colors • Two frame colors 	WIDTH: 24.0 DEPTH: 24.0 HEIGHT: 17.0
8191 	TB	CONNECTING 24" END-OF-RUN	640	<ul style="list-style-type: none"> • End-of-run table • Three laminate colors • Two frame colors • Linking tables are not intended for use with bench models (8102, 8103, 8104) 	WIDTH: 24.0 DEPTH: 24.0 HEIGHT: 13.5

FRAME COLORS

BLACK BF	SILVER SF
-------------	--------------

LAMINATE COLORS

BLACK BKL	DESIGNER WHITE DWL	PLATINUM PTL
--------------	--------------------------	-----------------

strata

let strata float into your office

MESH BACK UPHOLSTERED SEAT

GSA SIN # 33721

- Task, stool, conference and executive seating
- Aluminum frame and base
- Mesh or upholstered seat
- Height- and depth-adjustable lumbar standard
- Heavy duty multi-shift 24/7 optional (350 lb. rating)
- Warranted to 300 lbs.



CREATING STRATA MODEL NUMBER

MODEL NUMBER	CONTROL	ARMS	FRAME COLOR	MESH COLOR**	GRADE	BASE	CASTERS	PACKAGING	OPTIONS
15	Y2	A	F	M01		BA2	C		

** ONLY AVAILABLE IN BLACK MESH M01

PACKAGING NOTES

CODE	DESCRIPTION	LIST UPCHARGE
AB	ASSEMBLED IN BAG	\$0
PAC	PARTIALLY ASSEMBLED IN CARTON	\$0
BAC	BACK ASSEMBLED IN CARTON	\$80

MODEL	CONTROL	DESCRIPTION	ARM	FABRIC/LEATHER	FEATURES	DIMENSIONS	ARM OPTIONS	CASTER OPTIONS										
1560	Y2	MID-BACK HEAVY DUTY SYNCHRO TILT	A00	T01 870, A 919, B/COM 949, C 979, D 1039, E 1094, F 1134, G 1194, L3/COL 1094, L4 1119, L5 1269	<ul style="list-style-type: none"> • 4-position tilt lock • Side knob tension adjustment • 2:1 back-to-seat tilt ratio • 360° swivel • Pneumatic cylinder height adjustment 	WIDTH: 26.5 DEPTH: 26.5 HEIGHT: 39.5-44.0 SEAT WIDTH: 21.0 SEAT DEPTH: 18.0 SEAT HEIGHT: 17.0-21.5 SEAT HEIGHT W/ SEAT SLIDER: 18.0-22.5 BACK WIDTH: 21.0 BACK HEIGHT: 22.0 COM: 0.9 YD COL: 11.0 SQ FT WEIGHT: 50.0 LB												
A6	A7		A8B/S	A9B/S					A10	A36	A37							
SEAT SLIDER (SS) - ADD \$60																		
1580	Y2		HIGH-BACK W/ HEADREST HEAVY DUTY SYNCHRO TILT	A00					T01 930, A 979, B/COM 1009, C 1039, D 1099, E 1154, F 1194, G 1254, L3/COL 1154, L4 1224, L5 1329	<ul style="list-style-type: none"> • 4-position tilt lock • Side knob tension adjustment • 2:1 back-to-seat tilt ratio • 360° swivel • Pneumatic cylinder height adjustment 	WIDTH: 26.5 DEPTH: 26.5 HEIGHT: 46.5-51.0 SEAT WIDTH: 21.0 SEAT DEPTH: 18.0 SEAT HEIGHT: 17.0-21.5 SEAT HEIGHT W/ SEAT SLIDER: 18.0-22.5 BACK WIDTH: 21.0 BACK HEIGHT: 29.0 COM: 0.9 YD COL: 11.0 SQ FT WEIGHT: 51.0 LB							
A6	A7			A8B/S					A9B/S					A10	A36	A37		
SEAT SLIDER (SS) - ADD \$60																		
1566	Y2			MID-BACK 10" STOOL HEAVY DUTY SYNCHRO TILT					A00					T01 995, A 1044, B/COM 1074, C 1104, D 1164, E 1219, F 1259, G 1319, L3/COL 1219, L4 1244, L5 1394	<ul style="list-style-type: none"> • Height-adjustable 20" diameter foot ring • 4-position tilt lock • Side knob tension control • 2:1 back-to-seat tilt ratio • 360° swivel • Pneumatic cylinder height adjustment 	WIDTH: 26.5 DEPTH: 26.5 HEIGHT: 49.0-59.0 SEAT WIDTH: 21.0 SEAT DEPTH: 18.0 SEAT HEIGHT: 27.0-37.0 BACK WIDTH: 21.0 BACK HEIGHT: 22.0 COM: 0.9 YD COL: 11.0 SQ FT WEIGHT: 56.0 LB		
A6	A7								A8B/S					A9B/S				
SEAT SLIDER (SS) - NOT AVAILABLE																		
1568	Y2	MID-BACK 8" STOOL HEAVY DUTY SYNCHRO TILT			A00	T01 995, A 1044, B/COM 1074, C 1104, D 1164, E 1219, F 1259, G 1319, L3/COL 1219, L4 1244, L5 1394	<ul style="list-style-type: none"> • Height-adjustable 20" diameter foot ring • 4-position tilt lock • Side knob tension control • 2:1 back-to-seat tilt ratio • 360° swivel • Pneumatic cylinder height adjustment 	WIDTH: 26.5 DEPTH: 26.5 HEIGHT: 45.0-53.0 SEAT WIDTH: 21.0 SEAT DEPTH: 18.0 SEAT HEIGHT: 23.0-31.0 BACK WIDTH: 21.0 BACK HEIGHT: 22.0 COM: 0.9 YD COL: 11.0 SQ FT WEIGHT: 55.0 LB										
A6	A7				A8B/S	A9B/S												
SEAT SLIDER (SS) - NOT AVAILABLE																		

strata

let strata float into your office

ALL MESH

GSA SIN # 33721

- Task, stool, conference and executive seating
- Aluminum frame and base
- Mesh or upholstered seat
- Height- and depth-adjustable lumbar standard
- Warranted to 300 lbs.



CREATING STRATA MODEL NUMBER

MODEL NUMBER	CONTROL	ARMS	FRAME COLOR	MESH COLOR**	GRADE	BASE	CASTERS	PACKAGING	OPTIONS
15	Y2	A	F	M01		BA2	C		

** FOR ARMLESS USE CODE A00 ** ONLY AVAILABLE IN BLACK MESH M01

PACKAGING NOTES

CODE	DESCRIPTION	LIST UPCHARGE
AB	ASSEMBLED IN BAG	\$0
PAC	PARTIALLY ASSEMBLED IN CARTON	\$0
BAC	BACK ASSEMBLED IN CARTON	\$80

MODEL	CONTROL	DESCRIPTION	ARM	MESH	FEATURES	DIMENSIONS	ARM OPTIONS	CASTER OPTIONS	
1570	Y2	MID-BACK HEAVY DUTY SYNCHRO TILT	A00 A6 A7 A8B/S A9B/S A10 A36 A37	M 919 1079 1094 1024 1034 1029 1044 1059	<ul style="list-style-type: none"> • 4-position tilt lock • Side knob tension adjustment • 2:1 back-to-seat tilt ratio • 360° swivel • Pneumatic cylinder height adjustment 	WIDTH: 26.5 DEPTH: 26.5 HEIGHT: 39.5-44.0 SEAT WIDTH: 19.0 SEAT DEPTH: 18.0 SEAT HEIGHT: 17.0-21.5 SEAT HEIGHT W/ SEAT SLIDER: 18.0-22.5 BACK WIDTH: 21.5 BACK HEIGHT: 23.0 WEIGHT: 50.0 LB	A6 \$160 Height Adjustable Pivot Slide Arm A7 \$175 Height/Width Adjustable Pivot Slide Arm	C4 STD Heavy Duty Hard Wood Floor and Carpet Casters C1S C2S \$35 C1S - Hard Floor and Carpet Casters C2S - Decompression Hard Floor and Soft Carpet Casters	
				SEAT SLIDER (SS) - ADD \$60 - FACTORY INSTALLED					
1590	Y2	HIGH-BACK W/ HEADREST HEAVY DUTY SYNCHRO TILT	A00 A6 A7 A8B/S A9B/S A10 A36 A37	M 979 1139 1154 1084 1094 1089 1104 1119	<ul style="list-style-type: none"> • 4-position tilt lock • Side knob tension adjustment • 2:1 back-to-seat tilt ratio • 360° swivel • Pneumatic cylinder height adjustment 	WIDTH: 26.5 DEPTH: 26.5 HEIGHT: 46.5-51.0 SEAT WIDTH: 19.0 SEAT DEPTH: 18.0 SEAT HEIGHT: 17.0-21.5 SEAT HEIGHT W/ SEAT SLIDER: 18.0-22.5 BACK WIDTH: 21.5 BACK HEIGHT: 23.0 WEIGHT: 51.0 LB	A8B/S \$105 Height Adjustable Arm - Black/Silver A9B/S \$115 Height/Width Adjustable Arm - Black/Silver A10 \$110 Soft Touch C-Shaped Arm A36 \$125 Height Adjustable Pivot/Slide Arm		
				SEAT SLIDER (SS) - ADD \$60 - FACTORY INSTALLED					
1576	Y2	10" STOOL HEAVY DUTY SYNCHRO TILT Use for work surfaces up to 42" high	A00 A6 A7 A8B/S A9B/S A10 A36 A37	M 1044 1204 1219 1149 1159 1154 1169 1184	<ul style="list-style-type: none"> • Height-adjustable 20" diameter foot ring • 4-position tilt lock • Side knob tension control • 2:1 back-to-seat tilt ratio • 360° swivel • Pneumatic cylinder height adjustment 	WIDTH: 26.5 DEPTH: 26.5 HEIGHT: 49.0-59.0 SEAT WIDTH: 19.0 SEAT DEPTH: 18.0 SEAT HEIGHT: 25.0-35.0 BACK WIDTH: 21.5 BACK HEIGHT: 23.0 WEIGHT: 56.0 LB	A37 \$140 Height/Width Adjustable Pivot/Slide Arm A90 \$235 Height/Width Adjustable Breakaway Arm		
				SEAT SLIDER (SS) - NOT AVAILABLE					
1578	Y2	8" STOOL HEAVY DUTY SYNCHRO TILT Use for work surfaces up to 36" high	A00 A6 A7 A8B/S A9B/S A10 A36 A37	M 1044 1204 1219 1149 1159 1154 1169 1184	<ul style="list-style-type: none"> • Height-adjustable 20" diameter foot ring • 4-position tilt lock • Side knob tension control • 2:1 back-to-seat tilt ratio • 360° swivel • Pneumatic cylinder height adjustment 	WIDTH: 26.5 DEPTH: 26.5 HEIGHT: 45.0-53.0 SEAT WIDTH: 20.0 SEAT DEPTH: 17.5 SEAT HEIGHT: 22.0-30.0 BACK WIDTH: 21.5 BACK HEIGHT: 23.0 WEIGHT: 55.0 LB	BA2B/S STD 26" Aluminum Base BA2B - Black Powder Coat BA2S - Silver Powder Coat		
				SEAT SLIDER (SS) - NOT AVAILABLE					

BASE OPTIONS



26" Aluminum Base
BA2B - Black Powder Coat
BA2S - Silver Powder Coat

ADDITIONAL OPTIONS



Seat Slider 2.5"
Side Paddle Activated
Factory Installed

FRAME COLORS

CODE	DESCRIPTION
BF	BLACK
SF	SILVER

strata lite

let strata float into your office

MESH BACK UPHOLSTERED SEAT

GSA SIN # 33721

- Task, stool, conference and executive seating
- Nylon frame and base
- Mesh or upholstered seat
- Height- and depth-adjustable lumbar standard
- Warranted to 300 lbs.



CREATING STRATA MODEL NUMBER

MODEL NUMBER	CONTROL	ARMS	FRAME COLOR	MESH COLOR**	GRADE	BASE	CASTERS	PACKAGING	OPTIONS
15	Y2	A	F	M01		BA2	C		

** FOR ARMLESS USE CODE A00 ** ONLY AVAILABLE IN BLACK MESH M01

PACKAGING NOTES

CODE	DESCRIPTION	LIST UPCHARGE
AB	ASSEMBLED IN BAG	\$0
PAC	PARTIALLY ASSEMBLED IN CARTON	\$0
BAC	BACK ASSEMBLED IN CARTON	\$80

MODEL	CONTROL	DESCRIPTION	ARM	FABRIC/LEATHER	FEATURES	DIMENSIONS	ARM OPTIONS	CASTER OPTIONS		
1545	Y1	MID-BACK SIMPLE SYNCHRO TILT	A00	T01 758 807 837 867 927 982 1022 1082 982 1007 1157 A 918 967 997 1027 1087 1142 1182 1242 1142 1167 1317 A7 933 982 1012 1042 1102 1157 1197 1257 1157 1182 1332 A8B/S 863 912 942 972 1032 1087 1127 1187 1087 1112 1262 A9B/S 873 922 952 982 1042 1097 1137 1197 1097 1122 1272 A10 868 917 947 977 1037 1092 1132 1192 1092 1117 1267 A36 883 932 962 992 1052 1107 1147 1207 1107 1132 1282 A37 898 947 977 1007 1067 1122 1162 1222 1122 1147 1297	<ul style="list-style-type: none"> • Upright tilt lock • 3:1 back-to-seat tilt ratio • Center knob tension adjustment • 360° swivel • Pneumatic cylinder height adjustment 	WIDTH: 26.5 DEPTH: 26.5 HEIGHT: 39.5-44.0 SEAT WIDTH: 21.0 SEAT DEPTH: 18.0 SEAT HEIGHT: 17.0-21.5 SEAT HEIGHT W/ SEAT SLIDER: 18.0-22.5 BACK WIDTH: 21.0 BACK HEIGHT: 22.0 COM: 0.9 YD COL: 11.0 SQ FT WEIGHT: 46.0 LB	A6 \$160 Height Adjustable Pivot Slide Arm A7 \$175 Height/Width Adjustable Pivot Slide Arm	C4 STD Heavy Duty Hard Wood Floor and Carpet Casters		
SEAT SLIDER (SS) - ADD \$60										
1545	Y4		MID-BACK INTENSIVE SYNCHRO TILT	A00	T01 848 897 927 957 1017 1072 1112 1172 1072 1097 1247 A6 1008 1057 1087 1117 1177 1232 1272 1332 1232 1257 1407 A7 1023 1072 1102 1132 1192 1247 1287 1347 1247 1272 1422 A8B/S 953 1002 1032 1062 1122 1177 1217 1277 1177 1202 1352 A9B/S 963 1012 1042 1072 1132 1187 1227 1287 1187 1212 1362 A10 958 1007 1037 1067 1127 1182 1222 1282 1182 1207 1357 A36 973 1022 1052 1082 1142 1197 1237 1297 1197 1222 1372 A37 988 1037 1067 1097 1157 1212 1252 1312 1212 1237 1387	<ul style="list-style-type: none"> • Integrated seat slider • 4-position tilt lock • 5° forward tilt • Side knob tension adjustment • 2:1 back-to-seat tilt ratio • 360° swivel • Pneumatic cylinder height adjustment 	WIDTH: 26.5 DEPTH: 26.5 HEIGHT: 39.5-44.0 SEAT WIDTH: 21.0 SEAT DEPTH: 18.0 SEAT HEIGHT: 18.0-21.0 BACK WIDTH: 21.0 BACK HEIGHT: 22.0 COM: 0.9 YD COL: 11.0 SQ FT WEIGHT: 46.0 LB	A8B/S \$105 Height Adjustable Arm - Black/Silver A9B/S \$115 Height/Width Adjustable Arm - Black/Silver	C1S C2S \$35 C1S - Hard Floor and Carpet Casters C2S - Decompression Hard Floor and Soft Carpet Casters	
SEAT SLIDER (SS) - STANDARD										
1555	Y1			HIGH-BACK W/ HEADREST SIMPLE SYNCHRO TILT	A00	T01 818 867 897 927 967 1017 1072 1142 1042 1112 1217 A6 978 1027 1057 1087 1127 1177 1232 1302 1202 1272 1377 A7 993 1042 1072 1102 1142 1192 1247 1317 1217 1287 1392 A8B/S 923 972 1002 1032 1072 1122 1177 1247 1147 1217 1322 A9B/S 933 982 1012 1042 1082 1132 1187 1257 1157 1227 1332 A10 928 977 1007 1037 1077 1127 1182 1252 1152 1222 1327 A36 943 992 1022 1052 1092 1142 1197 1267 1167 1237 1342 A37 958 1007 1037 1067 1107 1157 1212 1282 1182 1252 1357	<ul style="list-style-type: none"> • Upright tilt lock • 3:1 back-to-seat tilt ratio • Center knob tension adjustment • 360° swivel • Pneumatic cylinder height adjustment 	WIDTH: 26.5 DEPTH: 26.5 HEIGHT: 46.5-51.0 SEAT WIDTH: 21.0 SEAT DEPTH: 18.0 SEAT HEIGHT: 17.0-21.5 SEAT HEIGHT W/ SEAT SLIDER: 18.0-22.5 BACK WIDTH: 21.0 BACK HEIGHT: 22.0 COM: 0.9 YD COL: 11.0 SQ FT WEIGHT: 47.0 LB	A10 \$110 Soft Touch C-Shaped Arm A36 \$125 Height Adjustable Pivot/Slide Arm A37 \$140 Height/Width Adjustable Pivot/Slide Arm A90 \$235 Height/Width Adjustable Breakaway Arm	SS \$60 Seat Slider 2.5" Side Paddle Activated factory installed
SEAT SLIDER (SS) - ADD \$60										
1555	Y4				HIGH-BACK W/ HEADREST INTENSIVE SYNCHRO TILT	A00	T01 908 957 987 1017 1057 1107 1162 1232 1132 1202 1307 A6 1068 1117 1147 1177 1217 1267 1322 1392 1292 1362 1467 A7 1083 1132 1162 1192 1232 1282 1337 1407 1307 1377 1482 A8B/S 1013 1062 1092 1122 1162 1212 1267 1337 1237 1307 1412 A9B/S 1023 1072 1102 1132 1172 1222 1277 1347 1247 1317 1422 A10 1018 1067 1097 1127 1167 1217 1272 1342 1242 1312 1417 A36 1033 1082 1112 1142 1182 1232 1287 1357 1257 1327 1432 A37 1048 1097 1127 1157 1197 1247 1302 1372 1272 1342 1447	<ul style="list-style-type: none"> • Integrated seat slider • 4-position tilt lock • 5° forward tilt • Side knob tension adjustment • 2:1 back-to-seat tilt ratio • 360° swivel • Pneumatic cylinder height adjustment 	WIDTH: 26.5 DEPTH: 26.5 HEIGHT: 46.5-51.0 SEAT WIDTH: 21.0 SEAT DEPTH: 18.0 SEAT HEIGHT: 18.0-21.0 BACK WIDTH: 21.0 BACK HEIGHT: 22.0 COM: 0.9 YD COL: 11.0 SQ FT WEIGHT: 47.0 LB	BA1B STD 26" Nylon Base - Black BA2B/S \$110 26" Aluminum Base BA2B - Black Powder Coat BA2S - Silver Powder Coat
SEAT SLIDER (SS) - STANDARD										

strata lite

let strata float into your office

GSA SIN # 33721

- Task, stool, conference and executive seating
- Nylon frame and base
- Mesh or upholstered seat
- Height- and depth-adjustable lumbar standard
- Warranted to 300 lbs.



CREATING STRATA MODEL NUMBER

MODEL NUMBER CONTROL ARMS FRAME COLOR MESH COLOR** GRADE BASE CASTERS PACKAGING OPTIONS

1 5 - Y 2 - A - F - M 0 1 - B A 2 - C

** ONLY AVAILABLE IN BLACK MESH M01

PACKAGING NOTES

CODE	DESCRIPTION	LIST UPCHARGE
AB	ASSEMBLED IN BAG	\$0
PAC	PARTIALLY ASSEMBLED IN CARTON	\$0
BAC	BACK ASSEMBLED IN CARTON	\$80

MESH BACK UPHOLSTERED SEAT STOOLS

MODEL	CONTROL	DESCRIPTION	ARM	FABRIC/LEATHER											FEATURES	DIMENSIONS	ARM OPTIONS	CASTER OPTIONS	
				T01	A	B/COM	C	D	E	F	G	L3/COL	L4	L5					
1546	Y1	MID-BACK 10" STOOL SIMPLE SYNCHRO TILT Use for work surfaces up to 42" high	A00	883	932	962	992	1052	1107	1147	1207	1107	1132	1282	<ul style="list-style-type: none"> • Height-adjustable 20" diameter foot ring • Upright tilt lock • 3:1 back-to-seat tilt ratio • Center knob tension adjustment • 360° swivel • Pneumatic cylinder height adjustment 	WIDTH: 26.5 DEPTH: 26.5 HEIGHT: 49.0-59.0 SEAT WIDTH: 21.0 SEAT DEPTH: 18.0 BACK WIDTH: 21.0 BACK HEIGHT: 22.0 COM: 0.9 YD COL: 11.0 SQ FT WEIGHT: 52.0 LB	A6 \$160 Height Adjustable Pivot Slide Arm	A7 \$175 Height/Width Adjustable Pivot Slide Arm	C4 STD Heavy Duty Hard Wood Floor and Carpet Casters
			A6	1043	1092	1122	1152	1212	1267	1307	1367	1267	1292	1442					
			A7	1058	1107	1137	1167	1227	1282	1322	1382	1282	1307	1457					
			A8B/S	988	1037	1067	1097	1157	1212	1252	1312	1212	1237	1387					
			A9B/S	998	1047	1077	1107	1167	1222	1262	1322	1222	1247	1397					
			A10	993	1042	1072	1102	1162	1217	1257	1317	1217	1242	1392					
			A36	1008	1057	1087	1117	1177	1232	1272	1332	1232	1257	1407					
A37	1023	1072	1102	1132	1192	1247	1287	1347	1247	1272	1422								
				SEAT SLIDER (SS) - NOT AVAILABLE															
1548	Y1	MID-BACK 8" STOOL SIMPLE SYNCHRO TILT Use for work surfaces up to 36" high	A00	883	932	962	992	1052	1107	1147	1207	1107	1132	1282	<ul style="list-style-type: none"> • Height-adjustable 20" diameter foot ring • Upright tilt lock • 3:1 back-to-seat tilt ratio • Center knob tension adjustment • 360° swivel • Pneumatic cylinder height adjustment 	WIDTH: 26.5 DEPTH: 26.5 HEIGHT: 45.0-53.0 SEAT WIDTH: 21.0 SEAT DEPTH: 18.0 BACK WIDTH: 21.0 BACK HEIGHT: 22.0 COM: 0.9 YD COL: 11.0 SQ FT WEIGHT: 49.5 LB	A8B/S \$105 Height Adjustable Arm - Black/Silver	A9B/S \$115 Height/Width Adjustable Arm - Black/Silver	C1S C2S \$35 C1S - Hard Floor and Carpet Casters C2S - Decompression Hard Floor and Soft Carpet Casters
			A6	1043	1092	1122	1152	1212	1267	1307	1367	1267	1292	1442					
			A7	1058	1107	1137	1167	1227	1282	1322	1382	1282	1307	1457					
			A8B/S	988	1037	1067	1097	1157	1212	1252	1312	1212	1237	1387					
			A9B/S	998	1047	1077	1107	1167	1222	1262	1322	1222	1247	1397					
			A10	993	1042	1072	1102	1162	1217	1257	1317	1217	1242	1392					
			A36	1008	1057	1087	1117	1177	1232	1272	1332	1232	1257	1407					
A37	1023	1072	1102	1132	1192	1247	1287	1347	1247	1272	1422								
				SEAT SLIDER (SS) - NOT AVAILABLE															
1549	Y1	MID-BACK 10" STOOL SIMPLE SYNCHRO TILT Use for work surfaces up to 42" high	A00	883	932	962	992	1052	1107	1147	1207	1107	1132	1282	<ul style="list-style-type: none"> • Height-adjustable 20" diameter foot ring • Upright tilt lock • 3:1 back-to-seat tilt ratio • Center knob tension adjustment • 360° swivel • Pneumatic cylinder height adjustment 	WIDTH: 26.5 DEPTH: 26.5 HEIGHT: 49.0-59.0 SEAT WIDTH: 21.0 SEAT DEPTH: 18.0 BACK WIDTH: 21.0 BACK HEIGHT: 22.0 COM: 0.9 YD COL: 11.0 SQ FT WEIGHT: 52.0 LB	A10 \$110 Soft Touch C-Shaped Arm	A36 \$125 Height Adjustable Pivot/Slide Arm	A37 \$140 Height/Width Adjustable Pivot/Slide Arm A90 \$235 Height/Width Adjustable Breakaway Arm
			A6	1043	1092	1122	1152	1212	1267	1307	1367	1267	1292	1442					
			A7	1058	1107	1137	1167	1227	1282	1322	1382	1282	1307	1457					
			A8B/S	988	1037	1067	1097	1157	1212	1252	1312	1212	1237	1387					
			A9B/S	998	1047	1077	1107	1167	1222	1262	1322	1222	1247	1397					
			A10	993	1042	1072	1102	1162	1217	1257	1317	1217	1242	1392					
			A36	1008	1057	1087	1117	1177	1232	1272	1332	1232	1257	1407					
A37	1023	1072	1102	1132	1192	1247	1287	1347	1247	1272	1422								
				SEAT SLIDER (SS) - NOT AVAILABLE															
1550	Y1	MID-BACK 8" STOOL SIMPLE SYNCHRO TILT Use for work surfaces up to 36" high	A00	883	932	962	992	1052	1107	1147	1207	1107	1132	1282	<ul style="list-style-type: none"> • Height-adjustable 20" diameter foot ring • Upright tilt lock • 3:1 back-to-seat tilt ratio • Center knob tension adjustment • 360° swivel • Pneumatic cylinder height adjustment 	WIDTH: 26.5 DEPTH: 26.5 HEIGHT: 45.0-53.0 SEAT WIDTH: 21.0 SEAT DEPTH: 18.0 BACK WIDTH: 21.0 BACK HEIGHT: 22.0 COM: 0.9 YD COL: 11.0 SQ FT WEIGHT: 49.5 LB	BA1B STD 26" Nylon Base - Black	BA2B/S \$110 26" Aluminum Base BA2B - Black Powder Coat BA2S - Silver Powder Coat	
			A6	1043	1092	1122	1152	1212	1267	1307	1367	1267	1292	1442					
			A7	1058	1107	1137	1167	1227	1282	1322	1382	1282	1307	1457					
			A8B/S	988	1037	1067	1097	1157	1212	1252	1312	1212	1237	1387					
			A9B/S	998	1047	1077	1107	1167	1222	1262	1322	1222	1247	1397					
			A10	993	1042	1072	1102	1162	1217	1257	1317	1217	1242	1392					
			A36	1008	1057	1087	1117	1177	1232	1272	1332	1232	1257	1407					
A37	1023	1072	1102	1132	1192	1247	1287	1347	1247	1272	1422								
				SEAT SLIDER (SS) - NOT AVAILABLE															

strata lite

let strata float into your office

ALL MESH

GSA SIN # 33721

- Task, stool, conference and executive seating
- Nylon frame and base
- Mesh or upholstered seat
- Height- and depth-adjustable lumbar standard
- Warranted to 300 lbs.



CREATING STRATA MODEL NUMBER

MODEL NUMBER	CONTROL	ARMS	FRAME COLOR	MESH COLOR**	GRADE	BASE	CASTERS	PACKAGING	OPTIONS
15	Y2	A	F	M01		BA2	C		

** FOR ARMLESS USE CODE A00 ** ONLY AVAILABLE IN BLACK MESH M01

PACKAGING NOTES

CODE	DESCRIPTION	LIST UPCHARGE
AB	ASSEMBLED IN BAG	\$0
PAC	PARTIALLY ASSEMBLED IN CARTON	\$0
BAC	BACK ASSEMBLED IN CARTON	\$80

MODEL	CONTROL	DESCRIPTION	ARM	MESH/LEATHER	T01	A	B/COM	C	D	E	F	G	L3/COL	L4	L5	FEATURES	DIMENSIONS	ARM OPTIONS	CASTER OPTIONS
1545	Y1	MID-BACK SIMPLE SYNCHRO TILT	A00	758	807	837	867	927	982	1022	1082	982	1007	1157	<ul style="list-style-type: none"> • Upright tilt lock • 3:1 back-to-seat tilt ratio • Center knob tension adjustment • 360° swivel • Pneumatic cylinder height adjustment 	WIDTH: 26.5 DEPTH: 26.5 HEIGHT: 39.5-44.0 SEAT WIDTH: 21.0 SEAT DEPTH: 18.0 SEAT HEIGHT: 17.0-21.5 SEAT HEIGHT W/ SEAT SLIDER: 18.0-22.5 BACK WIDTH: 21.0 BACK HEIGHT: 22.0 COM: 0.9 YD COL: 11.0 SQ FT WEIGHT: 46.0 LB	A6 \$160 Height Adjustable Pivot Slide Arm	A7 \$175 Height/Width Adjustable Pivot Slide Arm	C4 STD Heavy Duty Hard Wood Floor and Carpet Casters
			A6	918	967	997	1027	1087	1142	1182	1242	1142	1167	1317			A8B/S \$105 Height Adjustable Arm - Black/Silver	A9B/S \$115 Height/Width Adjustable Arm - Black/Silver	C1S C1S - Hard Floor and Carpet Casters
			A7	933	982	1012	1042	1102	1157	1197	1257	1157	1182	1332			C2S \$35 C2S - Decompression Hard Floor and Soft Carpet Casters		
			A8B/S	863	912	942	972	1032	1087	1127	1187	1087	1112	1262			A10 \$110 Soft Touch C-Shaped Arm	A36 \$125 Height Adjustable Pivot/Slide Arm	
			A9B/S	873	922	952	982	1042	1097	1137	1197	1097	1122	1272			A37 \$140 Height/Width Adjustable Pivot/Slide Arm	A90 \$235 Height/Width Adjustable Breakaway Arm	
			A10	868	917	947	977	1037	1092	1132	1192	1092	1117	1267			BA1B STD 26" Nylon Base - Black	BA2B/S \$110 26" Aluminum Base BA2B - Black Powder Coat BA2S - Silver Powder Coat	SS \$60 Seat Slider 2.5" Side Paddle Activated factory installed
			A36	883	932	962	992	1052	1107	1147	1207	1107	1132	1282					
		A37	898	947	977	1007	1067	1122	1162	1222	1122	1147	1297						
			SEAT SLIDER (SS) - ADD \$60																
1545	Y4	MID-BACK INTENSIVE SYNCHRO TILT	A00	848	897	927	957	1017	1072	1112	1172	1072	1097	1247	<ul style="list-style-type: none"> • Integrated seat slider • 4-position tilt lock • 5° forward tilt • Side knob tension adjustment • 2:1 back-to-seat tilt ratio • 360° swivel • Pneumatic cylinder height adjustment 	WIDTH: 26.5 DEPTH: 26.5 HEIGHT: 39.5-44.0 SEAT WIDTH: 21.0 SEAT DEPTH: 18.0 SEAT HEIGHT: 18.0-21.0 BACK WIDTH: 21.0 BACK HEIGHT: 22.0 COM: 0.9 YD COL: 11.0 SQ FT WEIGHT: 46.0 LB			
			A6	1008	1057	1087	1117	1177	1232	1272	1332	1232	1257	1407					
			A7	1023	1072	1102	1132	1192	1247	1287	1347	1247	1272	1422					
			A8B/S	953	1002	1032	1062	1122	1177	1217	1277	1177	1202	1352					
			A9B/S	963	1012	1042	1072	1132	1187	1227	1287	1187	1212	1362					
			A10	958	1007	1037	1067	1127	1182	1222	1282	1182	1207	1357					
			A36	973	1022	1052	1082	1142	1197	1237	1297	1197	1222	1372					
		A37	988	1037	1067	1097	1157	1212	1252	1312	1212	1237	1387						
			SEAT SLIDER (SS) - STANDARD																
1555	Y1	HIGH-BACK W/ HEADREST SIMPLE SYNCHRO TILT	A00	818	867	897	927	967	1017	1072	1142	1042	1112	1217	<ul style="list-style-type: none"> • Upright tilt lock • 3:1 back-to-seat tilt ratio • Center knob tension adjustment • 360° swivel • Pneumatic cylinder height adjustment 	WIDTH: 26.5 DEPTH: 26.5 HEIGHT: 46.5-51.0 SEAT WIDTH: 21.0 SEAT DEPTH: 18.0 SEAT HEIGHT: 17.0-21.5 SEAT HEIGHT W/ SEAT SLIDER: 18.0-22.5 BACK WIDTH: 21.0 BACK HEIGHT: 22.0 COM: 0.9 YD COL: 11.0 SQ FT WEIGHT: 47.0 LB			
			A6	978	1027	1057	1087	1127	1177	1232	1302	1202	1272	1377					
			A7	993	1042	1072	1102	1142	1192	1247	1317	1217	1287	1392					
			A8B/S	923	972	1002	1032	1072	1122	1177	1247	1147	1217	1322					
			A9B/S	933	982	1012	1042	1082	1132	1187	1257	1157	1227	1332					
			A10	928	977	1007	1037	1077	1127	1182	1252	1152	1222	1327					
			A36	943	992	1022	1052	1092	1142	1197	1267	1167	1237	1342					
		A37	958	1007	1037	1067	1107	1157	1212	1282	1182	1252	1357						
			SEAT SLIDER (SS) - ADD \$60																
1555	Y4	HIGH-BACK W/ HEADREST INTENSIVE SYNCHRO TILT	A00	908	957	987	1017	1057	1107	1162	1232	1132	1202	1307	<ul style="list-style-type: none"> • Integrated seat slider • 4-position tilt lock • 5° forward tilt • Side knob tension adjustment • 2:1 back-to-seat tilt ratio • 360° swivel • Pneumatic cylinder height adjustment 	WIDTH: 26.5 DEPTH: 26.5 HEIGHT: 46.5-51.0 SEAT WIDTH: 21.0 SEAT DEPTH: 18.0 SEAT HEIGHT: 18.0-21.0 BACK WIDTH: 21.0 BACK HEIGHT: 22.0 COM: 0.9 YD COL: 11.0 SQ FT WEIGHT: 47.0 LB			
			A6	1068	1117	1147	1177	1217	1267	1322	1392	1292	1362	1467					
			A7	1083	1132	1162	1192	1232	1282	1337	1407	1307	1377	1482					
			A8B/S	1013	1062	1092	1122	1162	1212	1267	1337	1237	1307	1412					
			A9B/S	1023	1072	1102	1132	1172	1222	1277	1347	1247	1317	1422					
			A10	1018	1067	1097	1127	1167	1217	1272	1342	1242	1312	1417					
			A36	1033	1082	1112	1142	1182	1232	1287	1357	1257	1327	1432					
		A37	1048	1097	1127	1157	1197	1247	1302	1372	1272	1342	1447						
			SEAT SLIDER (SS) - STANDARD																

strata lite

let strata float into your office

ALL MESH STOOLS

GSA SIN # 33721

- Task, stool, conference and executive seating
- Nylon frame and base
- Mesh or upholstered seat
- Height- and depth-adjustable lumbar standard
- Warranted to 300 lbs.



CREATING STRATA MODEL NUMBER

MODEL NUMBER	CONTROL	ARMS	FRAME COLOR	MESH COLOR**	GRADE	BASE	CASTERS	PACKAGING	OPTIONS
15	Y2	A	F	M01		BA2	C		

** FOR ARMLESS USE CODE A00 ** ONLY AVAILABLE IN BLACK MESH M01

PACKAGING NOTES

CODE	DESCRIPTION	LIST UPCHARGE
AB	ASSEMBLED IN BAG	\$0
PAC	PARTIALLY ASSEMBLED IN CARTON	\$0
BAC	BACK ASSEMBLED IN CARTON	\$80

MODEL	CONTROL	DESCRIPTION	ARM	MESH	FEATURES	DIMENSIONS	ARM OPTIONS	CASTER OPTIONS
1536	Y1	MID-BACK 10" STOOL SIMPLE SYNCHRO TILT Use for work surfaces up to 42" high	A00 A6 A7 A8B/S A9B/S A10 A36 A37	M 917 1077 1092 1022 1032 1027 1042 1057	<ul style="list-style-type: none"> • Upright tilt lock • 3:1 back-to-seat tilt ratio • Center knob tension adjustment • 360° swivel • Pneumatic cylinder height adjustment 	WIDTH: 26.5 DEPTH: 26.5 HEIGHT: 47.5-57.5 SEAT WIDTH: 20.0 SEAT DEPTH: 17.5 BACK WIDTH: 21.5 BACK HEIGHT: 23.0 WEIGHT: 52.2 LB	A6 \$160 Height Adjustable Pivot Slide Arm A7 \$175 Height/Width Adjustable Pivot Slide Arm A8B/S \$105 Height Adjustable Arm - Black/Silver A9B/S \$115 Height/Width Adjustable Arm - Black/Silver A10 \$110 Soft Touch C-Shaped Arm A36 \$125 Height Adjustable Pivot/Slide Arm A37 \$140 Height/Width Adjustable Pivot/Slide Arm A90 \$235 Height/Width Adjustable Breakaway Arm	C4 STD Heavy Duty Hard Wood Floor and Carpet Casters C1S C2S \$35 C1S - Hard Floor and Carpet Casters C2S - Decompression Hard Floor and Soft Carpet Casters
1538	Y1	MID-BACK 8" STOOL SIMPLE SYNCHRO TILT Use for work surfaces up to 36" high	A00 A6 A7 A8B/S A9B/S A10 A36 A37	M 917 1077 1092 1022 1032 1027 1042 1057	<ul style="list-style-type: none"> • Upright tilt lock • 3:1 back-to-seat tilt ratio • Center knob tension adjustment • 360° swivel • Pneumatic cylinder height adjustment 	WIDTH: 26.5 DEPTH: 26.5 HEIGHT: 44.0-52.0 SEAT WIDTH: 20.0 SEAT DEPTH: 17.5 BACK WIDTH: 21.5 BACK HEIGHT: 23.0 WEIGHT: 51.5 LB	BASE OPTIONS BA1B STD 26" Nylon Base - Black BA2B/S \$110 26" Aluminum Base BA2B - Black Powder Coat BA2S - Silver Powder Coat	

theory

the facts support theory as the smart choice

GSA SIN # 33721

- Task, stool, conference and executive seating
- Mesh or upholstered seat
- Ratchet back with independent height-adjustable lumbar standard
- Heavy duty multi-shift 24/7 optional (350 lb. rating)
- Warranted to 300 lbs.



CREATING THEORY MODEL NUMBER



PACKAGING NOTES

CODE	DESCRIPTION	LIST UPCHARGE
AB	ASSEMBLED IN BAG	\$0
PAC	PARTIALLY ASSEMBLED IN CARTON	\$0
BAC	BACK ASSEMBLED IN CARTON	\$80

MID-BACK MESH BACK UPHOLSTERED SEAT AND STOOLS

MODEL	CONTROL	DESCRIPTION	ARM	FABRIC/LEATHER	FEATURES	DIMENSIONS																																																																													
2160	Y1	MID-BACK SIMPLE SYNCHRO TILT	A00 A8B/S A9B/S A10 A36 A37	<table border="1"> <thead> <tr> <th>T01</th> <th>A</th> <th>B/COM</th> <th>C</th> <th>D</th> <th>E</th> <th>F</th> <th>G</th> <th>L3/COL</th> <th>L4</th> <th>L5</th> </tr> </thead> <tbody> <tr><td>750</td><td>802</td><td>832</td><td>862</td><td>922</td><td>977</td><td>1017</td><td>1077</td><td>977</td><td>1002</td><td>1152</td></tr> <tr><td>855</td><td>907</td><td>937</td><td>967</td><td>1027</td><td>1082</td><td>1122</td><td>1182</td><td>1082</td><td>1107</td><td>1257</td></tr> <tr><td>865</td><td>917</td><td>947</td><td>977</td><td>1037</td><td>1092</td><td>1132</td><td>1192</td><td>1092</td><td>1117</td><td>1267</td></tr> <tr><td>860</td><td>912</td><td>942</td><td>972</td><td>1032</td><td>1087</td><td>1127</td><td>1187</td><td>1087</td><td>1112</td><td>1262</td></tr> <tr><td>875</td><td>927</td><td>957</td><td>987</td><td>1047</td><td>1102</td><td>1142</td><td>1202</td><td>1102</td><td>1127</td><td>1277</td></tr> <tr><td>890</td><td>942</td><td>972</td><td>1002</td><td>1062</td><td>1117</td><td>1157</td><td>1217</td><td>1117</td><td>1142</td><td>1292</td></tr> </tbody> </table>	T01	A	B/COM	C	D	E	F	G	L3/COL	L4	L5	750	802	832	862	922	977	1017	1077	977	1002	1152	855	907	937	967	1027	1082	1122	1182	1082	1107	1257	865	917	947	977	1037	1092	1132	1192	1092	1117	1267	860	912	942	972	1032	1087	1127	1187	1087	1112	1262	875	927	957	987	1047	1102	1142	1202	1102	1127	1277	890	942	972	1002	1062	1117	1157	1217	1117	1142	1292	<ul style="list-style-type: none"> • Upright tilt lock • 3:1 back-to-seat tilt ratio • Center knob tension adjustment • 360° swivel • Pneumatic cylinder height adjustment 	WIDTH: 26.5 DEPTH: 25.0 HEIGHT: 39.5-46.5 SEAT WIDTH: 21.0 SEAT DEPTH: 18.0 SEAT HEIGHT: 16.0-20.5 SEAT HEIGHT W/ SEAT SLIDER: 17.5-22.0 BACK WIDTH: 20.0 BACK HEIGHT: 23.0-25.0 COM: 0.9 YD COL: 11.0 SQ FT WEIGHT: 42.0 LB
T01	A	B/COM	C	D	E	F	G	L3/COL	L4	L5																																																																									
750	802	832	862	922	977	1017	1077	977	1002	1152																																																																									
855	907	937	967	1027	1082	1122	1182	1082	1107	1257																																																																									
865	917	947	977	1037	1092	1132	1192	1092	1117	1267																																																																									
860	912	942	972	1032	1087	1127	1187	1087	1112	1262																																																																									
875	927	957	987	1047	1102	1142	1202	1102	1127	1277																																																																									
890	942	972	1002	1062	1117	1157	1217	1117	1142	1292																																																																									
2160	Y3	MID-BACK FULL SYNCHRO TILT	A00 A8B/S A9B/S A10 A36 A37	<table border="1"> <thead> <tr> <th>T01</th> <th>A</th> <th>B/COM</th> <th>C</th> <th>D</th> <th>E</th> <th>F</th> <th>G</th> <th>L3/COL</th> <th>L4</th> <th>L5</th> </tr> </thead> <tbody> <tr><td>810</td><td>862</td><td>892</td><td>922</td><td>982</td><td>1037</td><td>1077</td><td>1137</td><td>1037</td><td>1062</td><td>1212</td></tr> <tr><td>915</td><td>967</td><td>997</td><td>1027</td><td>1087</td><td>1142</td><td>1182</td><td>1242</td><td>1142</td><td>1167</td><td>1317</td></tr> <tr><td>925</td><td>977</td><td>1007</td><td>1037</td><td>1097</td><td>1152</td><td>1192</td><td>1252</td><td>1152</td><td>1177</td><td>1327</td></tr> <tr><td>920</td><td>972</td><td>1002</td><td>1032</td><td>1092</td><td>1147</td><td>1187</td><td>1247</td><td>1147</td><td>1172</td><td>1322</td></tr> <tr><td>935</td><td>987</td><td>1017</td><td>1047</td><td>1107</td><td>1162</td><td>1202</td><td>1262</td><td>1162</td><td>1187</td><td>1337</td></tr> <tr><td>950</td><td>1002</td><td>1032</td><td>1062</td><td>1122</td><td>1177</td><td>1217</td><td>1277</td><td>1177</td><td>1202</td><td>1352</td></tr> </tbody> </table>	T01	A	B/COM	C	D	E	F	G	L3/COL	L4	L5	810	862	892	922	982	1037	1077	1137	1037	1062	1212	915	967	997	1027	1087	1142	1182	1242	1142	1167	1317	925	977	1007	1037	1097	1152	1192	1252	1152	1177	1327	920	972	1002	1032	1092	1147	1187	1247	1147	1172	1322	935	987	1017	1047	1107	1162	1202	1262	1162	1187	1337	950	1002	1032	1062	1122	1177	1217	1277	1177	1202	1352	<ul style="list-style-type: none"> • 3-position tilt lock • 2:1 back-to-seat tilt ratio • Center knob tension adjustment • 360° swivel • Pneumatic cylinder height adjustment 	WIDTH: 26.5 DEPTH: 24.5 HEIGHT: 39.5-46.5 SEAT WIDTH: 21.0 SEAT DEPTH: 18.0 SEAT HEIGHT: 17.0-21.5 SEAT HEIGHT W/ SEAT SLIDER: 18.5-23.0 BACK WIDTH: 20.0 BACK HEIGHT: 23.0-25.0 COM: 0.9 YD COL: 11.0 SQ FT WEIGHT: 43.5 LB
T01	A	B/COM	C	D	E	F	G	L3/COL	L4	L5																																																																									
810	862	892	922	982	1037	1077	1137	1037	1062	1212																																																																									
915	967	997	1027	1087	1142	1182	1242	1142	1167	1317																																																																									
925	977	1007	1037	1097	1152	1192	1252	1152	1177	1327																																																																									
920	972	1002	1032	1092	1147	1187	1247	1147	1172	1322																																																																									
935	987	1017	1047	1107	1162	1202	1262	1162	1187	1337																																																																									
950	1002	1032	1062	1122	1177	1217	1277	1177	1202	1352																																																																									
2160	Y2	MID-BACK HEAVY DUTY SYNCHRO TILT	A00 A8B/S A9B/S A10 A36 A37	<table border="1"> <thead> <tr> <th>T01</th> <th>A</th> <th>B/COM</th> <th>C</th> <th>D</th> <th>E</th> <th>F</th> <th>G</th> <th>L3/COL</th> <th>L4</th> <th>L5</th> </tr> </thead> <tbody> <tr><td>840</td><td>892</td><td>922</td><td>952</td><td>1012</td><td>1067</td><td>1107</td><td>1167</td><td>1067</td><td>1092</td><td>1242</td></tr> <tr><td>945</td><td>997</td><td>1027</td><td>1057</td><td>1117</td><td>1172</td><td>1212</td><td>1272</td><td>1172</td><td>1197</td><td>1347</td></tr> <tr><td>955</td><td>1007</td><td>1037</td><td>1067</td><td>1127</td><td>1182</td><td>1222</td><td>1282</td><td>1182</td><td>1207</td><td>1357</td></tr> <tr><td>950</td><td>1002</td><td>1032</td><td>1062</td><td>1122</td><td>1177</td><td>1217</td><td>1277</td><td>1177</td><td>1202</td><td>1352</td></tr> <tr><td>965</td><td>1017</td><td>1047</td><td>1077</td><td>1137</td><td>1192</td><td>1232</td><td>1292</td><td>1192</td><td>1217</td><td>1367</td></tr> <tr><td>980</td><td>1032</td><td>1062</td><td>1092</td><td>1152</td><td>1207</td><td>1247</td><td>1307</td><td>1207</td><td>1232</td><td>1382</td></tr> </tbody> </table>	T01	A	B/COM	C	D	E	F	G	L3/COL	L4	L5	840	892	922	952	1012	1067	1107	1167	1067	1092	1242	945	997	1027	1057	1117	1172	1212	1272	1172	1197	1347	955	1007	1037	1067	1127	1182	1222	1282	1182	1207	1357	950	1002	1032	1062	1122	1177	1217	1277	1177	1202	1352	965	1017	1047	1077	1137	1192	1232	1292	1192	1217	1367	980	1032	1062	1092	1152	1207	1247	1307	1207	1232	1382	<ul style="list-style-type: none"> • 4-position tilt lock • Side knob tension adjustment • 2:1 back-to-seat tilt ratio • 360° swivel • Pneumatic cylinder height adjustment 	WIDTH: 26.5 DEPTH: 25.0 HEIGHT: 38.0-45.0 SEAT WIDTH: 21.0 SEAT DEPTH: 18.5 SEAT HEIGHT: 16.5-21.5 SEAT HEIGHT W/ SEAT SLIDER: 18.0-23.0 BACK WIDTH: 20.0 BACK HEIGHT: 21.5-23.5 COM: 0.9 YD COL: 11.0 SQ FT WEIGHT: 45.5 LB
T01	A	B/COM	C	D	E	F	G	L3/COL	L4	L5																																																																									
840	892	922	952	1012	1067	1107	1167	1067	1092	1242																																																																									
945	997	1027	1057	1117	1172	1212	1272	1172	1197	1347																																																																									
955	1007	1037	1067	1127	1182	1222	1282	1182	1207	1357																																																																									
950	1002	1032	1062	1122	1177	1217	1277	1177	1202	1352																																																																									
965	1017	1047	1077	1137	1192	1232	1292	1192	1217	1367																																																																									
980	1032	1062	1092	1152	1207	1247	1307	1207	1232	1382																																																																									
2166	Y1	10" STOOL SIMPLE SYNCHRO TILT	A00 A8B/S A9B/S A10 A36 A37	<table border="1"> <thead> <tr> <th>T01</th> <th>A</th> <th>B/COM</th> <th>C</th> <th>D</th> <th>E</th> <th>F</th> <th>G</th> <th>L3/COL</th> <th>L4</th> <th>L5</th> </tr> </thead> <tbody> <tr><td>875</td><td>927</td><td>957</td><td>987</td><td>1047</td><td>1102</td><td>1142</td><td>1202</td><td>1102</td><td>1127</td><td>1277</td></tr> <tr><td>980</td><td>1032</td><td>1062</td><td>1092</td><td>1152</td><td>1207</td><td>1247</td><td>1307</td><td>1207</td><td>1232</td><td>1382</td></tr> <tr><td>990</td><td>1042</td><td>1072</td><td>1102</td><td>1162</td><td>1217</td><td>1257</td><td>1317</td><td>1217</td><td>1242</td><td>1392</td></tr> <tr><td>985</td><td>1037</td><td>1067</td><td>1097</td><td>1157</td><td>1212</td><td>1252</td><td>1312</td><td>1212</td><td>1237</td><td>1387</td></tr> <tr><td>1000</td><td>1052</td><td>1082</td><td>1112</td><td>1172</td><td>1227</td><td>1267</td><td>1327</td><td>1227</td><td>1252</td><td>1402</td></tr> <tr><td>1015</td><td>1067</td><td>1097</td><td>1127</td><td>1187</td><td>1242</td><td>1282</td><td>1342</td><td>1242</td><td>1267</td><td>1417</td></tr> </tbody> </table>	T01	A	B/COM	C	D	E	F	G	L3/COL	L4	L5	875	927	957	987	1047	1102	1142	1202	1102	1127	1277	980	1032	1062	1092	1152	1207	1247	1307	1207	1232	1382	990	1042	1072	1102	1162	1217	1257	1317	1217	1242	1392	985	1037	1067	1097	1157	1212	1252	1312	1212	1237	1387	1000	1052	1082	1112	1172	1227	1267	1327	1227	1252	1402	1015	1067	1097	1127	1187	1242	1282	1342	1242	1267	1417	<ul style="list-style-type: none"> • Height-adjustable 20" diameter foot ring • Upright tilt lock • 3:1 back-to-seat tilt ratio • Center knob tension control • 360° swivel • Pneumatic cylinder height adjustment 	WIDTH: 26.5 DEPTH: 26.5 HEIGHT: 48.0-60.5 SEAT WIDTH: 21.0 SEAT DEPTH: 20.0 SEAT HEIGHT: 26.5-36.5 BACK WIDTH: 20.5 BACK HEIGHT: 21.0-24.0 COM: 0.9 YD COL: 11.0 SQ FT WEIGHT: 48.0 LB
T01	A	B/COM	C	D	E	F	G	L3/COL	L4	L5																																																																									
875	927	957	987	1047	1102	1142	1202	1102	1127	1277																																																																									
980	1032	1062	1092	1152	1207	1247	1307	1207	1232	1382																																																																									
990	1042	1072	1102	1162	1217	1257	1317	1217	1242	1392																																																																									
985	1037	1067	1097	1157	1212	1252	1312	1212	1237	1387																																																																									
1000	1052	1082	1112	1172	1227	1267	1327	1227	1252	1402																																																																									
1015	1067	1097	1127	1187	1242	1282	1342	1242	1267	1417																																																																									
2168	Y1	8" STOOL SIMPLE SYNCHRO TILT	A00 A8B/S A9B/S A10 A36 A37	<table border="1"> <thead> <tr> <th>T01</th> <th>A</th> <th>B/COM</th> <th>C</th> <th>D</th> <th>E</th> <th>F</th> <th>G</th> <th>L3/COL</th> <th>L4</th> <th>L5</th> </tr> </thead> <tbody> <tr><td>875</td><td>927</td><td>957</td><td>987</td><td>1047</td><td>1102</td><td>1142</td><td>1202</td><td>1102</td><td>1127</td><td>1277</td></tr> <tr><td>980</td><td>1032</td><td>1062</td><td>1092</td><td>1152</td><td>1207</td><td>1247</td><td>1307</td><td>1207</td><td>1232</td><td>1382</td></tr> <tr><td>990</td><td>1042</td><td>1072</td><td>1102</td><td>1162</td><td>1217</td><td>1257</td><td>1317</td><td>1217</td><td>1242</td><td>1392</td></tr> <tr><td>985</td><td>1037</td><td>1067</td><td>1097</td><td>1157</td><td>1212</td><td>1252</td><td>1312</td><td>1212</td><td>1237</td><td>1387</td></tr> <tr><td>1000</td><td>1052</td><td>1082</td><td>1112</td><td>1172</td><td>1227</td><td>1267</td><td>1327</td><td>1227</td><td>1252</td><td>1402</td></tr> <tr><td>1015</td><td>1067</td><td>1097</td><td>1127</td><td>1187</td><td>1242</td><td>1282</td><td>1342</td><td>1242</td><td>1267</td><td>1417</td></tr> </tbody> </table>	T01	A	B/COM	C	D	E	F	G	L3/COL	L4	L5	875	927	957	987	1047	1102	1142	1202	1102	1127	1277	980	1032	1062	1092	1152	1207	1247	1307	1207	1232	1382	990	1042	1072	1102	1162	1217	1257	1317	1217	1242	1392	985	1037	1067	1097	1157	1212	1252	1312	1212	1237	1387	1000	1052	1082	1112	1172	1227	1267	1327	1227	1252	1402	1015	1067	1097	1127	1187	1242	1282	1342	1242	1267	1417	<ul style="list-style-type: none"> • Height-adjustable 20" diameter foot ring • Upright tilt lock • 3:1 back-to-seat tilt ratio • Center knob tension control • 360° swivel • Pneumatic cylinder height adjustment 	WIDTH: 26.5 DEPTH: 26.5 HEIGHT: 45.0-55.5 SEAT WIDTH: 21.0 SEAT DEPTH: 20.0 SEAT HEIGHT: 24-32 BACK WIDTH: 20.5 BACK HEIGHT: 21.0-24.0 COM: 0.9 YD COL: 11.0 SQ FT WEIGHT: 48.0 LB
T01	A	B/COM	C	D	E	F	G	L3/COL	L4	L5																																																																									
875	927	957	987	1047	1102	1142	1202	1102	1127	1277																																																																									
980	1032	1062	1092	1152	1207	1247	1307	1207	1232	1382																																																																									
990	1042	1072	1102	1162	1217	1257	1317	1217	1242	1392																																																																									
985	1037	1067	1097	1157	1212	1252	1312	1212	1237	1387																																																																									
1000	1052	1082	1112	1172	1227	1267	1327	1227	1252	1402																																																																									
1015	1067	1097	1127	1187	1242	1282	1342	1242	1267	1417																																																																									

ARM OPTIONS

A10
\$110

Soft Touch C-Shaped Arm

A8B/S
\$105

Height Adjustable Arm -
A8B - Black
A8S - Silver

A9B/S
\$115

Height/Width Adjustable Arm -
A9B - Black
A9S - Silver

A36
\$125

Height Adjustable
Pivot/Slide Arm

A37
\$140

Height/Width Adjustable
Pivot/Slide Arm

A90
\$235

Height/Width Adjustable
Breakaway Arm

CASTER OPTIONS

C6
STD

Large Diameter Carpet Casters

C6S
\$35

Large Diameter Hard Floor
and Carpet Casters

C7
\$35

Chrome-Accented Hard Floor
and Carpet Casters

BASE OPTIONS

BA11B
STD

27" Mid-Profile Nylon Base
BA11B - Black

BA12B/P/S
\$110

27" Mid-Profile Aluminum Base
BA12B - Black Powder Coat
BA12P - Polished
BA12S - Silver Powder Coat

MESH COLORS

M1

BLACK
M11

M1 MESH
NC

ADDITIONAL OPTIONS

SS
\$60

Seat Slider 2.5"
Side Paddle Activated

HD
\$125

Heavy Duty Multi-Shift
Upgrade 350 lb. Includes
BA12 and C6S. Available
with Y2 only.

theory

the facts support theory as the smart choice

GSA SIN # 33721

- Task, stool, conference and executive seating
- Mesh or upholstered seat
- Ratchet back with independent height-adjustable lumbar standard
- Heavy duty multi-shift 24/7 optional (350 lb. rating)
- Warranted to 300 lbs.



CREATING THEORY MODEL NUMBER

MODEL NUMBER CONTROL ARMS BACK MESH COLOR GRADE BASE CASTERS PACKAGING OPTIONS

2 1 8 0 - Y - A - M - B A - C - - -

* FOR ARMLESS USE CODE A00 * IF BASE AND CASTER MODEL NUMBERS ARE LEFT BLANK THEN STANDARD OPTION WILL BE ASSUMED

PACKAGING NOTES

CODE	DESCRIPTION	LIST UPCHARGE
AB	ASSEMBLED IN BAG	\$0
PAC	PARTIALLY ASSEMBLED IN CARTON	\$0
BAC	BACK ASSEMBLED IN CARTON	\$80

HIGH-BACK MESH BACK UPHOLSTERED SEAT

MODEL	CONTROL	DESCRIPTION	ARM	FABRIC/LEATHER	FEATURES										DIMENSIONS	
2180	Y1	HIGH-BACK SIMPLE SYNCHRO TILT	A00	T01	A	B/COM	C	D	E	F	G	L3/COL	L4	L5	<ul style="list-style-type: none"> • Upright tilt lock • 3:1 back-to-seat tilt ratio • Center knob tension adjustment • 360° swivel • Pneumatic cylinder height adjustment 	WIDTH: 26.5 DEPTH: 25.0 HEIGHT: 45.0-54.5 SEAT WIDTH: 21.0 SEAT DEPTH: 20.0 SEAT HEIGHT: 17.5-22.0 SEAT HEIGHT W/ SEAT SLIDER: 19.0-23.5 BACK WIDTH: 20.5 BACK HEIGHT: 28.0-32.5 COM: 0.9 YD COL: 14.0 SQ FT WEIGHT: 42.0 LB
			A8B/S	835	887	917	947	1007	1062	1102	1162	1062	1132	1237		
			A9B/S	940	992	1022	1052	1112	1167	1207	1267	1167	1237	1342		
			A10	950	1002	1032	1062	1122	1177	1217	1277	1177	1247	1352		
			A36	945	997	1027	1057	1117	1172	1212	1272	1172	1242	1347		
			A37	960	1012	1042	1072	1132	1187	1227	1287	1187	1257	1362		
			975	1027	1057	1087	1147	1202	1242	1302	1202	1272	1377			
					SEAT SLIDER (SS) - ADD \$60											

MODEL	CONTROL	DESCRIPTION	ARM	FABRIC/LEATHER	FEATURES										DIMENSIONS	
2180	Y3	HIGH-BACK FULL SYNCHRO TILT	A00	T01	A	B/COM	C	D	E	F	G	L3/COL	L4	L5	<ul style="list-style-type: none"> • 3-position tilt lock • 2:1 back-to-seat tilt ratio • Center knob tension adjustment • 360° swivel • Pneumatic cylinder height adjustment 	WIDTH: 26.5 DEPTH: 25.0 HEIGHT: 45.0-54.5 SEAT WIDTH: 21.0 SEAT DEPTH: 20.0 SEAT HEIGHT: 17.5-22.0 SEAT HEIGHT W/ SEAT SLIDER: 19.0-23.5 BACK WIDTH: 20.5 BACK HEIGHT: 28.0-32.5 COM: 0.9 YD COL: 14.0 SQ FT WEIGHT: 48.0 LB
			A8B/S	895	947	977	1007	1067	1122	1162	1222	1122	1192	1297		
			A9B/S	1000	1052	1082	1112	1172	1227	1267	1327	1227	1297	1402		
			A10	1010	1062	1092	1122	1182	1237	1277	1337	1237	1307	1412		
			A36	1005	1057	1087	1117	1177	1232	1272	1332	1232	1302	1407		
			A37	1020	1072	1102	1132	1192	1247	1287	1347	1247	1317	1422		
			1035	1087	1117	1147	1207	1262	1302	1362	1262	1332	1437			
					SEAT SLIDER (SS) - ADD \$60											

MODEL	CONTROL	DESCRIPTION	ARM	FABRIC/LEATHER	FEATURES										DIMENSIONS	
2180	Y2	HIGH-BACK HEAVY DUTY SYNCHRO TILT	A00	T01	A	B/COM	C	D	E	F	G	L3/COL	L4	L5	<ul style="list-style-type: none"> • 4-position tilt lock • Side knob tension adjustment • 2:1 back-to-seat tilt ratio • 360° swivel • Pneumatic cylinder height adjustment 	WIDTH: 26.5 DEPTH: 26.5 HEIGHT: 45.0-54.5 SEAT WIDTH: 21.0 SEAT DEPTH: 20.0 SEAT HEIGHT: 17.5-23.0 SEAT HEIGHT W/ SEAT SLIDER: 19.0-23.5 BACK WIDTH: 20.5 BACK HEIGHT: 28.0-32.5 COM: 0.9 YD COL: 14.0 SQ FT WEIGHT: 48.0 LB
			A8B/S	925	977	1007	1037	1097	1152	1192	1252	1152	1222	1327		
			A9B/S	1030	1082	1112	1142	1202	1257	1297	1357	1257	1327	1432		
			A10	1040	1092	1122	1152	1212	1267	1307	1367	1267	1337	1442		
			A36	1035	1087	1117	1147	1207	1262	1302	1362	1262	1332	1437		
			A37	1050	1102	1132	1162	1222	1277	1317	1377	1277	1347	1452		
			1065	1117	1147	1177	1237	1292	1332	1392	1292	1362	1467			
					SEAT SLIDER (SS) - ADD \$60											

ARM OPTIONS



Soft Touch C-Shaped Arm



Height Adjustable Arm -
A8B - Black
A8S - Silver



Height/Width Adjustable Arm -
A9B - Black
A9S - Silver



Height Adjustable
Pivot/Slide Arm



Height/Width Adjustable
Pivot/Slide Arm



Height/Width Adjustable
Breakaway Arm

CASTER OPTIONS



Large Diameter Carpet Casters



Large Diameter Hard Floor
and Carpet Casters



Chrome-Accented Hard Floor
and Carpet Casters

BASE OPTIONS



27" Mid-Profile Nylon Base
BA11B - Black



27" Mid-Profile Aluminum Base
BA12B - Black Powder Coat
BA12P - Polished
BA12S - Silver Powder Coat

MESH COLORS



ADDITIONAL OPTIONS



Seat Slider 2.5"
Side Paddle Activated



Heavy Duty Multi-Shift
Upgrade 350 lb. Includes
BA12 Aluminum Base and
C6S Casters; Available
with Y2 Only

theory

the facts support theory as the smart choice

MID-BACK ALL MESH

GSA SIN # 33721

- Task, stool, conference and executive seating
- Mesh or upholstered seat
- Ratchet back with independent height-adjustable lumbar standard
- Warranted to 300 lbs.



CREATING THEORY MODEL NUMBER

MODEL NUMBER	CONTROL	ARMS	MESH COLOR	BASE	CASTERS	PACKAGING	OPTIONS
2170	Y	A	M	BA	C		

* FOR ARMLESS USE CODE A00 * IF BASE AND CASTER MODEL NUMBERS ARE LEFT BLANK THEN STANDARD OPTION WILL BE ASSUMED

PACKAGING NOTES

CODE	DESCRIPTION	LIST UPCHARGE
AB	ASSEMBLED IN BAG	\$0
PAC	PARTIALLY ASSEMBLED IN CARTON	\$0
BAC	BACK ASSEMBLED IN CARTON	\$80

MODEL	CONTROL	DESCRIPTION	ARM	MESH	FEATURES	DIMENSIONS	ARM OPTIONS	CASTER OPTIONS
2170	Y1	MID-BACK SIMPLE SYNCHRO TILT	A00 A8B/S A9B/S A10 A36 A37	M 802 907 917 912 927 942	<ul style="list-style-type: none"> • Upright tilt lock • 3:1 back-to-seat tilt ratio • Center knob tension adjustment • 360° swivel • Pneumatic cylinder height adjustment 	WIDTH: 26.5 DEPTH: 26.5 HEIGHT: 38.5-45.5 SEAT WIDTH: 20.0 SEAT DEPTH: 18.0 SEAT HEIGHT: 17.0-20.5 SEAT HEIGHT W/ SEAT SLIDER: 19.0-23.5 BACK WIDTH: 20.5 BACK HEIGHT: 22.5-25.5 COM: N/A COL: N/A WEIGHT: 46.0 LB	 	
2170	Y3	MID-BACK FULL SYNCHRO TILT	A00 A8B/S A9B/S A10 A36 A37	M 862 967 977 972 987 1002	<ul style="list-style-type: none"> • 3-position tilt lock • 2:1 back-to-seat tilt ratio • Center knob tension adjustment • 360° swivel • Pneumatic cylinder height adjustment 	WIDTH: 26.5 DEPTH: 26.5 HEIGHT: 37.5-44.5 SEAT WIDTH: 20.0 SEAT DEPTH: 18.0 SEAT HEIGHT: 16.5-21.0 SEAT HEIGHT W/ SEAT SLIDER: 19.0-23.5 BACK WIDTH: 20.5 BACK HEIGHT: 22.5-25.5 COM: N/A COL: N/A WEIGHT: 46.0 LB	 	
2170	Y2	MID-BACK HEAVY DUTY SYNCHRO TILT	A00 A8B/S A9B/S A10 A36 A37	M 892 997 1007 1002 1017 1032	<ul style="list-style-type: none"> • 4-position tilt lock • Side knob tension adjustment • 2:1 back-to-seat tilt ratio • 360° swivel • Pneumatic cylinder height adjustment 	WIDTH: 24.0 DEPTH: 26.5 HEIGHT: 38.5-46.0 SEAT WIDTH: 19.5 SEAT DEPTH: 18.0 SEAT HEIGHT: 17.0-21.5 SEAT HEIGHT W/ SEAT SLIDER: 19.0-23.5 BACK WIDTH: 20.5 BACK HEIGHT: 22.5-25.5 COM: N/A COL: N/A WEIGHT: 46.0 LB	 	
2176	Y1	10" STOOL SIMPLE SYNCHRO TILT Use for work surfaces up to 42" high	A00 A8B/S A9B/S A10 A36 A37	M 927 1032 1042 1037 1052 1067	<ul style="list-style-type: none"> • Height-adjustable 20" diameter foot ring • Upright tilt lock • 3:1 back-to-seat tilt ratio • Center knob tension control • 360° swivel • Pneumatic cylinder height adjustment 	WIDTH: 26.5 DEPTH: 26.5 HEIGHT: 47.25-60.5 SEAT WIDTH: 19.5 SEAT DEPTH: 18.0 SEAT HEIGHT: 26.0-36.0 BACK WIDTH: 20.0 BACK HEIGHT: 22.5-25.5 COM: NA COL: NA WEIGHT: 56.0 LB	 	
2178	Y1	8" STOOL SIMPLE SYNCHRO TILT Use for work surfaces up to 36" high	A00 A8B/S A9B/S A10 A36 A37	M 927 1032 1042 1037 1052 1067	<ul style="list-style-type: none"> • Height-adjustable 20" diameter foot ring • Upright tilt lock • 3:1 back-to-seat tilt ratio • Center knob tension control • 360° swivel • Pneumatic cylinder height adjustment 	WIDTH: 26.5 DEPTH: 26.5 HEIGHT: 44.25-55.5 SEAT WIDTH: 19.5 SEAT DEPTH: 18.0 SEAT HEIGHT: 23.5-31.5 BACK WIDTH: 20.0 BACK HEIGHT: 22.5-25.5 COM: NA COL: NA WEIGHT: 55.0 LB		

theory

the facts support theory as the smart choice

HIGH-BACK ALL MESH

GSA SIN # 33721

- Task, stool, conference and executive seating
- Mesh or upholstered seat
- Ratchet back with independent height-adjustable lumbar standard
- Warranted to 300 lbs.



CREATING THEORY MODEL NUMBER

MODEL NUMBER	CONTROL	ARMS	MESH COLOR	BASE	CASTERS	PACKAGING	OPTIONS
2190	-Y	-A	-M	-BA	-C		

* FOR ARMLESS USE CODE A00 * IF BASE AND CASTER MODEL NUMBERS ARE LEFT BLANK THEN STANDARD OPTION WILL BE ASSUMED

PACKAGING NOTES

CODE	DESCRIPTION	LIST UPCHARGE
AB	ASSEMBLED IN BAG	\$0
PAC	PARTIALLY ASSEMBLED IN CARTON	\$0
BAC	BACK ASSEMBLED IN CARTON	\$80

MODEL	CONTROL	DESCRIPTION	ARM	MESH	FEATURES	DIMENSIONS
2190	Y1	HIGH-BACK SIMPLE SYNCHRO TILT	A00 A8B/S A9B/S A10 A36 A37	M 887 992 1002 997 1012 1027	<ul style="list-style-type: none"> • Upright tilt lock • 3:1 back-to-seat tilt ratio • Center knob tension adjustment • 360° swivel • Pneumatic cylinder height adjustment 	WIDTH: 24.0 DEPTH: 25.5 HEIGHT: 45.0-54.5 SEAT WIDTH: 20.0 SEAT DEPTH: 18.0 SEAT HEIGHT: 17.0-20.5 SEAT HEIGHT W/ SEAT SLIDER: 18.5-22.0 BACK WIDTH: 20.0 BACK HEIGHT: 30.0-35.0 COM: N/A COL: N/A WEIGHT: 42.0 LB
			SEAT SLIDER (SS) - ADD \$60 - FACTORY INSTALLED			
2190	Y3	HIGH-BACK FULL SYNCHRO TILT	A00 A8B/S A9B/S A10 A36 A37	M 947 1052 1062 1057 1072 1087	<ul style="list-style-type: none"> • 3-position tilt lock • 2:1 back-to-seat tilt ratio • Center knob tension adjustment • 360° swivel • Pneumatic cylinder height adjustment 	WIDTH: 24.0 DEPTH: 26.0 HEIGHT: 44.5-53.5 SEAT WIDTH: 20.0 SEAT DEPTH: 18.0 SEAT HEIGHT: 16.5-21.0 SEAT HEIGHT W/ SEAT SLIDER: 18.0-22.5 BACK WIDTH: 20.0 BACK HEIGHT: 30.5-35.0 COM: N/A COL: N/A WEIGHT: 44.0 LB
			SEAT SLIDER (SS) - ADD \$60 - FACTORY INSTALLED			
2190	Y2	HIGH-BACK HEAVY DUTY SYNCHRO TILT	A00 A8B/S A9B/S A10 A36 A37	M 977 1082 1092 1087 1102 1117	<ul style="list-style-type: none"> • 4-position tilt lock • Side knob tension adjustment • 2:1 back-to-seat tilt ratio • 360° swivel • Pneumatic cylinder height adjustment 	WIDTH: 24.0 DEPTH: 25.0 HEIGHT: 45.5-55.0 SEAT WIDTH: 20.0 SEAT DEPTH: 17.5 SEAT HEIGHT: 17.0-21.5 SEAT HEIGHT W/ SEAT SLIDER: 18.5-23.0 BACK WIDTH: 20.0 BACK HEIGHT: 30.0-34.5 COM: N/A COL: N/A WEIGHT: 46.5 LB
			SEAT SLIDER (SS) - ADD \$60 - FACTORY INSTALLED			

ARM OPTIONS

<p>A10 \$110</p> <p>Soft Touch C-Shaped Arm</p>	<p>A8B/S \$105</p> <p>Height Adjustable Arm - A8B - Black, A8S - Silver</p>
<p>A9B/S \$115</p> <p>Height/Width Adjustable Arm - A9B - Black, A9S - Silver</p>	<p>A36 \$125</p> <p>Height Adjustable Pivot/Slide Arm</p>
<p>A37 \$140</p> <p>Height/Width Adjustable Pivot/Slide Arm</p>	<p>A90 \$235</p> <p>Height/Width Adjustable Breakaway Arm</p>

CASTER OPTIONS

<p>C6 STD</p> <p>Large Diameter Carpet Casters</p>
<p>C6S \$35</p> <p>Large Diameter Hard Floor and Carpet Casters</p>
<p>C7 \$35</p> <p>Chrome-Accented Hard Floor and Carpet Casters</p>

BASE OPTIONS

<p>BA11B STD</p> <p>27" Mid-Profile Nylon Base BA11B - Black</p>	<p>BA12B/P/S \$110</p> <p>27" Mid-Profile Aluminum Base BA12B - Black Powder Coat BA12P - Polished BA12S - Silver Powder Coat</p>
---	--

ADDITIONAL OPTIONS

<p>SS \$60</p> <p>Seat Slider 2.5" Side Paddle Activated</p>

MESH COLORS

M1	BLACK M11	M1 MESH	NC
----	-----------	----------------	----

tori

unparalleled performance with impact

GSA SIN # 33721 PENDING

- Task, stool, conference and executive seating
- Wraparound back design
- Mid-back and high-back models
- Mesh back or upholstered back models
- Multiple frame and mesh colors
- Seat slider and lumbar available
- Warranted to 300 lbs



CREATING TORI MODEL NUMBER

MODEL NUMBER	CONTROL	ARMS	PLASTIC COLOR	MESH COLOR	GRADE	BASE	CASTERS	OPTIONS
3560	-Y	-A	-P	-M6			-C	

* IF ARMLESS USE CODE A00
* IF BASE AND CASTER MODEL NUMBERS ARE LEFT BLANK THEN STANDARD OPTION WILL BE ASSUMED

PACKAGING NOTES

CODE	DESCRIPTION	LIST UPCHARGE
AB	ASSEMBLED IN BAG	\$0
PAC	PARTIALLY ASSEMBLED IN CARTON	\$0
BAC	BACK ASSEMBLED IN CARTON	\$80

NEW MID-BACK - MESH BACK (MB) & UPHOLSTERED BACK (UB) - AVAILABLE IN MAY

MODEL	CONTROL	DESCRIPTION	ARM	FABRIC/LEATHER	FEATURES	DIMENSIONS
3560	Y1	MESH BACK MID-BACK SIMPLE-SYNCHRO TILT	A00	A B/COM C D E F G 785 815 845 905 960 1000 1060	<ul style="list-style-type: none"> • Upright tilt lock • 3:1 back-to seat tilt ratio • Center knob tension adjustment • 360° swivel • Pneumatic cylinder height adjustment 	WIDTH: 26.5 DEPTH: 24.5 HEIGHT: 37.0-42.0 SEAT WIDTH: 20.5 SEAT DEPTH: 18.5 SEAT HEIGHT: 17.0-22.0 BACK WIDTH: 20.0 BACK HEIGHT: 20.0 COM: 0.9 YD COL: 4.02 SQ FT WEIGHT: 37.0 LB
			A43	805 835 865 925 980 1020 1080		
			A57	815 845 875 935 990 1030 1090		
			A58	850 880 910 970 1025 1065 1125		
			A59	885 915 945 1005 1060 1100 1160		
3560	Y1-SS	MESH BACK MID-BACK SIMPLE-SYNCHRO TILT WITH SEAT SLIDER	A00	A B/COM C D E F G 845 875 905 965 1020 1060 1120	<ul style="list-style-type: none"> • Integrated seat slider • Upright tilt lock • 3:1 back-to seat tilt ratio • Center knob tension adjustment • 360° swivel • Pneumatic cylinder height adjustment 	WIDTH: 26.5 DEPTH: 24.5 HEIGHT: 37.0-42.0 SEAT WIDTH: 20.5 SEAT DEPTH: 18.5 SEAT HEIGHT: 17.0-22.0 BACK WIDTH: 20.0 BACK HEIGHT: 20.0 COM: 0.9 YD COL: 4.02 SQ FT WEIGHT: 37.0 LB
			A43	865 895 925 985 1040 1080 1140		
			A57	875 905 935 995 1050 1090 1150		
			A58	910 940 970 1030 1085 1125 1185		
			A59	945 975 1005 1065 1120 1160 1220		
3560	Y6	MESH BACK MID-BACK DELUXE SYNCHRO TILT	A00	A B/COM C D E F G 890 920 950 1010 1065 1105 1165	<ul style="list-style-type: none"> • Integrated seat slider • 4-position tilt lock • Side knob tension adjustment • 2:1 back-to seat tilt ratio • 360° swivel • Pneumatic cylinder height adjustment 	WIDTH: 26.5 DEPTH: 24.5 HEIGHT: 37.0-42.0 SEAT WIDTH: 20.5 SEAT DEPTH: 18.5 SEAT HEIGHT: 16.0-21.00 BACK WIDTH: 20.0 BACK HEIGHT: 20.0 COM: 0.9 YD COL: 4.02 SQ FT WEIGHT: 37.0 LB
			A43	910 940 970 1030 1085 1125 1185		
			A57	920 950 980 1040 1095 1135 1195		
			A58	955 985 1015 1075 1130 1170 1230		
			A59	990 1020 1050 1110 1165 1205 1265		
3560	Y1	UPHOLSTERED BACK MID-BACK SIMPLE-SYNCHRO TILT	A00	A B/COM C D E F G 850 920 978 1040 1145 1250 1350	<ul style="list-style-type: none"> • Upright tilt lock • 3:1 back-to seat tilt ratio • Center knob tension adjustment • 360° swivel • Pneumatic cylinder height adjustment 	WIDTH: 26.5 DEPTH: 24.5 HEIGHT: 37.0-42.0 SEAT WIDTH: 20.5 SEAT DEPTH: 18.5 SEAT HEIGHT: 17.0-22.0 BACK WIDTH: 20.0 BACK HEIGHT: 20.0 COM: 1.85 YD COL: 7.42 SQ FT WEIGHT: 37.0 LB
			A43	870 940 998 1060 1165 1270 1370		
			A57	880 950 1008 1070 1175 1280 1380		
			A58	915 985 1043 1105 1210 1315 1415		
			A59	950 1020 1078 1140 1245 1350 1450		
3560	Y1-SS	UPHOLSTERED BACK MID-BACK SIMPLE-SYNCHRO TILT WITH SEAT SLIDER	A00	A B/COM C D E F G 910 980 1038 1100 1205 1310 1410	<ul style="list-style-type: none"> • Integrated seat slider • Upright tilt lock • 3:1 back-to seat tilt ratio • Center knob tension adjustment • 360° swivel • Pneumatic cylinder height adjustment 	WIDTH: 26.5 DEPTH: 24.5 HEIGHT: 37.0-42.0 SEAT WIDTH: 20.5 SEAT DEPTH: 18.5 SEAT HEIGHT: 17.0-22.0 BACK WIDTH: 20.0 BACK HEIGHT: 20.0 COM: 1.85 YD COL: 7.42 SQ FT WEIGHT: 37.0 LB
			A43	930 1000 1058 1120 1225 1330 1430		
			A57	940 1010 1068 1130 1235 1340 1440		
			A58	975 1045 1103 1165 1270 1375 1475		
			A59	1010 1080 1138 1200 1305 1410 1510		
3560	Y6	UPHOLSTERED BACK MID-BACK DELUXE SYNCHRO TILT	A00	A B/COM C D E F G 955 1025 1083 1145 1250 1355 1455	<ul style="list-style-type: none"> • Integrated seat slider • 4-position tilt lock • Side knob tension adjustment • 2:1 back-to seat tilt ratio • 360° swivel • Pneumatic cylinder height adjustment 	WIDTH: 26.5 DEPTH: 24.5 HEIGHT: 37.0-42.0 SEAT WIDTH: 20.5 SEAT DEPTH: 18.5 SEAT HEIGHT: 16.0-21.00 BACK WIDTH: 20.0 BACK HEIGHT: 20.0 COM: 1.85 YD COL: 7.42 SQ FT WEIGHT: 37.0 LB
			A43	975 1045 1103 1165 1270 1375 1475		
			A57	985 1055 1113 1175 1280 1385 1485		
			A58	1020 1090 1148 1210 1315 1420 1520		
			A59	1055 1125 1183 1245 1350 1455 1555		

ARM OPTIONS

A43B/D
\$75

Fixed Arm
A43B - Black
A43D - Dove Gray

A57B/D/W
\$90

Height Adjustable
A57B - Black
A57D - Dove Gray
A57W - White

A58B/D/W
\$125

Height/Width Adjustable
A58B - Black
A58D - Dove Gray
A58W - White

A59B/D/W
\$160

Height/Width Adjustable
Pivot/Slide pad
A59B - Black
A59D - Dove Gray
A59W - White

CASTER OPTIONS

C6
STD

Large Diameter Carpet Casters

C6S
\$35

Large Diameter Hard Floor and Carpet Casters

C6D/W
STD

Large Diameter Carpet Casters
C6D - Dove Gray
C6W - White

C7
\$35

Chrome-Accented Hard Floor and Carpet Casters

BASE OPTIONS

BA26B/D/W
STD

27" Low Profile Nylon Base
BA26B - Black
BA26D - Dove Gray
BA26W - White

BA36P/S
\$110

27" Low Profile Aluminum Base
BA36P - Polished
BA36S - Silver

STOOL OPTIONS

CY30B
\$125

8" Stool - Y1 Only
Seat Height 21"-29"
Available with Mid-Back only

CY36B
\$125

10" Stool - Y1 Only
Seat Height 24"-34"
Available with Mid-Back only

CYLINDER OPTIONS

CY17
STD

Low Cylinder-CY17
Seat Height 15"-18"

CY20
STD

Standard Cylinder-CY20
Seat Height 16"-21"

CY24
STD

High Cylinder-CY24
Seat Height 19"-24"
*FR20-Foot Ring can be added - \$90 list

MESH COLORS

M6	BLACK M61	GRAY M62	WHITE M63
M6	BLUE M64	GREEN M65	

PLASTIC COLORS

BLACK PBK	DOVE GRAY PDG	WHITE PWH
NC	\$35	\$35

ADDITIONAL OPTIONS

LB
\$30

Height Adjustable Lumbar

HD
\$125

Heavy Duty Multi-Shift Upgrade 350 lb. Includes BA36P/S Low Profile Aluminum Base (Y6 control only) with C7 casters

TT
\$50

Two Tone Contrasting Upholstery (seat and back)

* If the two upholstery selections are of different grades, the chair will price at the higher of the two grades.

tori

unparalleled performance with impact

GSA SIN # 33721 PENDING

- Task, stool, conference and executive seating
- Wraparound back design
- Mid-back and high-back models
- Mesh back or upholstered back models
- Multiple frame and mesh colors
- Seat slider and lumbar available
- Warranted to 300 lbs



CREATING TORI MODEL NUMBER

MODEL NUMBER	CONTROL	ARMS	PLASTIC COLOR	MESH COLOR	GRADE	BASE	CASTERS	OPTIONS
3580	Y		A				C	

* IF BASE AND CASTER MODEL NUMBERS ARE LEFT BLANK THEN STANDARD OPTION WILL BE ASSUMED

PACKAGING NOTES

CODE	DESCRIPTION	LIST UPCHARGE
AB	ASSEMBLED IN BAG	\$0
PAC	PARTIALLY ASSEMBLED IN CARTON	\$0
BAC	BACK ASSEMBLED IN CARTON	\$80

NEW HIGH-BACK - MESH BACK (MB) & UPHOLSTERED BACK (UB)

MODEL	CONTROL	DESCRIPTION	ARM	FABRIC/LEATHER	FEATURES	DIMENSIONS
3580	Y1	MESH BACK HIGH-BACK SIMPLE-SYNCHRO TILT	A00	A B/COM C D E F G	<ul style="list-style-type: none"> • Upright tilt lock • 3:1 back-to seat tilt ratio • Center knob tension adjustment • 360° swivel • Pneumatic cylinder height adjustment 	WIDTH: 26.5 DEPTH: 24.5 HEIGHT: 40.0-45.0 SEAT WIDTH: 20.5 SEAT DEPTH: 18.5 SEAT HEIGHT: 17.0-22.0 BACK WIDTH: 24.0 COM: 0.9 YD COL: 4.02 SQ FT WEIGHT: 38.5 LB
			A43	790 820 850 910 965 1005 1065		
			A57	820 850 880 940 995 1035 1095		
			A58	855 885 915 975 1030 1070 1130		
			A59	890 920 950 1010 1065 1105 1165		
3580	Y1-SS	MESH BACK HIGH-BACK SIMPLE-SYNCHRO TILT WITH SEAT SLIDER	A00	A B/COM C D E F G	<ul style="list-style-type: none"> • Integrated seat slider • Upright tilt lock • 3:1 back-to seat tilt ratio • Center knob tension adjustment • 360° swivel • Pneumatic cylinder height adjustment 	WIDTH: 26.5 DEPTH: 24.5 HEIGHT: 40.0-45.0 SEAT WIDTH: 20.5 SEAT DEPTH: 18.5 SEAT HEIGHT: 17.0-22.0 BACK WIDTH: 24.0 COM: 0.9 YD COL: 4.02 SQ FT WEIGHT: 38.5 LB
			A43	850 880 910 970 1025 1065 1125		
			A57	880 910 940 1000 1055 1095 1155		
			A58	915 945 975 1035 1090 1130 1190		
			A59	950 980 1010 1070 1125 1165 1225		
3580	Y6	MESH BACK HIGH-BACK DELUXE SYNCHRO TILT	A00	A B/COM C D E F G	<ul style="list-style-type: none"> • Integrated seat slider • 4-position tilt lock • Side knob tension adjustment • 2:1 back-to seat tilt ratio • 360° swivel • Pneumatic cylinder height adjustment 	WIDTH: 26.5 DEPTH: 24.5 HEIGHT: 40.0-45.0 SEAT WIDTH: 20.5 SEAT DEPTH: 18.5 SEAT HEIGHT: 16.0-21.0 BACK WIDTH: 20.0 BACK HEIGHT: 24.0 COM: 0.9 YD COL: 4.02 SQ FT WEIGHT: 38.5 LB
			A43	895 925 955 1015 1070 1110 1170		
			A57	915 945 975 1035 1090 1130 1190		
			A58	925 955 985 1045 1100 1140 1200		
			A59	960 990 1020 1080 1135 1175 1235		
3580	Y1	UPHOLSTERED BACK HIGH-BACK SIMPLE-SYNCHRO TILT	A00	A B/COM C D E F G	<ul style="list-style-type: none"> • Upright tilt lock • 3:1 back-to seat tilt ratio • Center knob tension adjustment • 360° swivel • Pneumatic cylinder height adjustment 	WIDTH: 26.5 DEPTH: 24.5 HEIGHT: 40.0-45.0 SEAT WIDTH: 20.5 SEAT DEPTH: 18.5 SEAT HEIGHT: 17.0-22.0 BACK WIDTH: 20.0 COM: 2.0 YD COL: 8.88 SQ FT WEIGHT: 38.5 LB
			A43	855 925 983 1045 1150 1255 1355		
			A57	875 945 1003 1065 1170 1275 1375		
			A58	885 955 1013 1075 1180 1285 1385		
			A59	920 990 1048 1110 1215 1320 1420		
3580	Y1-SS	UPHOLSTERED BACK HIGH-BACK SIMPLE-SYNCHRO TILT WITH SEAT SLIDER	A00	A B/COM C D E F G	<ul style="list-style-type: none"> • Integrated seat slider • Upright tilt lock • 3:1 back-to seat tilt ratio • Center knob tension adjustment • 360° swivel • Pneumatic cylinder height adjustment 	WIDTH: 26.5 DEPTH: 24.5 HEIGHT: 40.0-45.0 SEAT WIDTH: 20.5 SEAT DEPTH: 18.5 SEAT HEIGHT: 17.0-22.0 BACK WIDTH: 20.0 COM: 2.0 YD COL: 8.88 SQ FT WEIGHT: 38.5 LB
			A43	915 985 1043 1105 1210 1315 1415		
			A57	935 1005 1063 1125 1230 1335 1435		
			A58	945 1015 1073 1135 1240 1345 1445		
			A59	980 1050 1108 1170 1275 1380 1480		
3580	Y6	UPHOLSTERED BACK HIGH-BACK DELUXE SYNCHRO TILT	A00	A B/COM C D E F G	<ul style="list-style-type: none"> • Integrated seat slider • 4-position tilt lock • Side knob tension adjustment • 2:1 back-to seat tilt ratio • 360° swivel • Pneumatic cylinder height adjustment 	WIDTH: 26.5 DEPTH: 24.5 HEIGHT: 40.0-45.0 SEAT WIDTH: 20.5 SEAT DEPTH: 18.5 SEAT HEIGHT: 16.0-21.0 BACK WIDTH: 20.0 COM: 2.0 YD COL: 8.88 SQ FT WEIGHT: 38.5 LB
			A43	960 1030 1088 1150 1255 1360 1460		
			A57	980 1050 1108 1170 1275 1380 1480		
			A58	990 1060 1118 1180 1285 1390 1490		
			A59	1025 1095 1153 1215 1320 1425 1525		

ARM OPTIONS

A43B/D
\$75

Fixed Arm
A43B - Black
A43D - Dove Gray

A57B/D/W
\$90

Height Adjustable
A57B - Black
A57D - Dove Gray
A57W - White

A58B/D/W
\$125

Height/Width Adjustable
A58B - Black
A58D - Dove Gray
A58W - White

A59B/D/W
\$160

Height/Width Adjustable
Pivot/Slide pad
A59B - Black
A59D - Dove Gray
A59W - White

CASTER OPTIONS

C6
STD

Large Diameter Carpet Casters

C6S
\$35

Large Diameter Hard Floor and Carpet Casters

C6D/W
STD

Large Diameter Carpet Casters
C6D - Dove Gray
C6W - White

C7
\$35

Chrome-Accented Hard Floor and Carpet Casters

BASE OPTIONS

BA26B/D/W
STD

27" Low Profile Nylon Base
BA26B - Black
BA26D - Dove Gray
BA26W - White

BA36P/S
\$110

27" Low Profile Aluminum Base
BA36P - Polished
BA36S - Silver

CYLINDER OPTIONS

CY17
STD

Low Cylinder-CY17
Seat Height 15"-18"

CY20
STD

Standard Cylinder-CY20
Seat Height 16"-21"

CY24
STD

High Cylinder-CY24
Seat Height 19"-24"
*FR20-Foot Ring can be added - \$90 list

MESH COLORS

M6	BLACK M61	GRAY M62	WHITE M63
M6	BLUE M64	GREEN M65	

PLASTIC COLORS

BLACK PBK	DOVE GRAY PDG	WHITE PWH
NC	\$35	\$35

ADDITIONAL OPTIONS

LB
\$30

Height Adjustable Lumbar

HD
\$125

Heavy Duty Multi-Shift Upgrade 350 lb. Includes BA36P/S Low Profile Aluminum Base (Y6 control only) with C7 casters

TT
\$50

Two Tone Contrasting Upholstery (seat and back)
* If the two upholstery selections are of different grades, the chair will price at the higher of the two grades.

vault

goes beyond the expected

MID-BACK

GSA SIN # 33721

- Task, stool, conference and executive seating
- Ratchet back lumbar height adjustment
- Seat slider standard
- Warranted to 300 lbs.



CREATING VAULT MODEL NUMBER

MODEL NUMBER	CONTROL	ARMS	BACK MESH COLOR	GRADE	BASE	CASTERS	PACKAGING	OPTIONS
1460		A	M		BA	C		

* FOR ARMLESS USE CODE A00
* IF BASE AND CASTER MODEL NUMBERS ARE LEFT BLANK THEN STANDARD OPTION WILL BE ASSUMED

PACKAGING NOTES

CODE	DESCRIPTION	LIST UPCHARGE
AB	ASSEMBLED IN BAG	\$0
PAC	PARTIALLY ASSEMBLED IN CARTON	\$0
BAC	BACK ASSEMBLED IN CARTON	\$80

MODEL CONTROL DESCRIPTION

ARM

FABRIC/LEATHER

FEATURES

DIMENSIONS

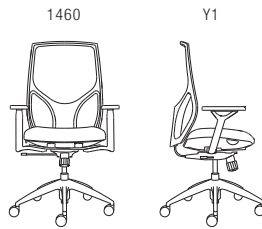

MID-BACK SIMPLE SYNCHRO TILT

	T01	A	B/COM	C	D	E	F	G	L3/COL	L4	L5
A00	667	692	722	752	812	867	907	967	867	892	1042
A6	827	852	882	912	972	1027	1067	1127	1027	1052	1202
A7	842	867	897	927	987	1042	1082	1142	1042	1067	1217
A8B/S	772	797	827	857	917	972	1012	1072	972	997	1147
A9B/S	782	807	837	867	927	982	1022	1082	982	1007	1157
A10	777	802	832	862	922	977	1017	1077	977	1002	1152
A36	792	817	847	877	937	992	1032	1092	992	1017	1167
A37	807	832	862	892	952	1007	1047	1107	1007	1032	1182

- Upright tilt lock
- 3:1 back-to-seat tilt ratio
- Center knob tension adjustment
- 360° swivel
- Pneumatic cylinder height adjustment

WIDTH: 24.5-26.0
DEPTH: 25.0
HEIGHT: 39.0-46.0
SEAT WIDTH: 20.0
SEAT DEPTH: 16.0-18.5
SEAT HEIGHT: 17.5-22.5
BACK WIDTH: 18.5
BACK HEIGHT: 23.0-25.5
COM: 0.9 YD
COL: 11.0 SQ FT
WEIGHT: 40.5 LB

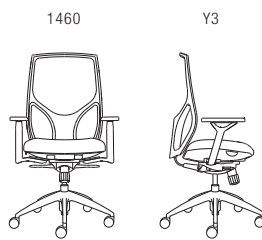

MID-BACK FULL SYNCHRO TILT

	T01	A	B/COM	C	D	E	F	G	L3/COL	L4	L5
A00	727	752	782	812	872	927	967	1027	927	952	1102
A6	887	912	942	972	1032	1087	1127	1187	1087	1112	1262
A7	902	927	957	987	1047	1102	1142	1202	1102	1127	1277
A8B/S	832	857	887	917	977	1032	1072	1132	1032	1057	1207
A9B/S	842	867	897	927	987	1042	1082	1142	1042	1067	1217
A10	837	862	892	922	982	1037	1077	1137	1037	1062	1212
A36	852	877	907	937	997	1052	1092	1152	1052	1077	1227
A37	867	892	922	952	1012	1067	1107	1167	1067	1092	1242

- 3-position tilt lock
- 2:1 back-to-seat tilt ratio
- Center knob tension adjustment
- 360° swivel
- Pneumatic cylinder height adjustment

WIDTH: 24.5-26.0
DEPTH: 25.0
HEIGHT: 39.0-46.0
SEAT WIDTH: 20.0
SEAT DEPTH: 16.0-18.5
SEAT HEIGHT: 17.5-22.5
BACK WIDTH: 18.5
BACK HEIGHT: 23.0-25.5
COM: 0.9 YD
COL: 11.0 SQ FT
WEIGHT: 41.0 LB

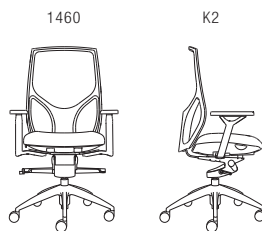

MID-BACK ENHANCED KNEE TILT

	T01	A	B/COM	C	D	E	F	G	L3/COL	L4	L5
A00	757	782	812	842	902	957	997	1057	957	982	1132
A6	917	942	972	1002	1062	1117	1157	1217	1117	1142	1292
A7	932	957	987	1017	1077	1132	1172	1232	1132	1157	1307
A8B/S	862	887	917	947	1007	1062	1102	1162	1062	1087	1237
A9B/S	872	897	927	957	1017	1072	1112	1172	1072	1097	1247
A10	867	892	922	952	1012	1067	1107	1167	1067	1092	1242
A36	882	907	937	967	1027	1082	1122	1182	1082	1107	1257
A37	897	922	952	982	1042	1097	1137	1197	1097	1122	1272

- 4-position tilt lock
- Side knob tension adjustment
- 360° swivel
- Pneumatic cylinder height adjustment

WIDTH: 24.5-26.0
DEPTH: 25.0
HEIGHT: 39.5-46.5
SEAT WIDTH: 20.0
SEAT DEPTH: 16.0-18.5
SEAT HEIGHT: 18.5-21.5
BACK WIDTH: 18.5
BACK HEIGHT: 23.0-25.5
COM: 0.9 YD
COL: 11.0 SQ FT
WEIGHT: 41.0 LB

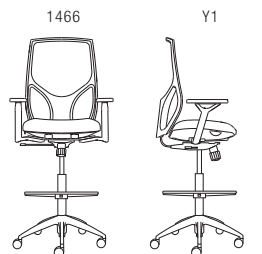

10" STOOL SIMPLE SYNCHRO TILT

Use for work surfaces up to 42" high

	T01	A	B/COM	C	D	E	F	G	L3/COL	L4	L5
A00	792	817	847	877	937	992	1032	1092	992	1017	1167
A6	952	977	1007	1037	1097	1152	1192	1252	1152	1177	1327
A7	967	992	1022	1052	1112	1167	1207	1267	1167	1192	1342
A8B/S	897	922	952	982	1042	1097	1137	1197	1097	1122	1272
A9B/S	907	932	962	992	1052	1107	1147	1207	1107	1132	1282
A10	902	927	957	987	1047	1102	1142	1202	1102	1127	1277
A36	917	942	972	1002	1062	1117	1157	1217	1117	1142	1292
A37	932	957	987	1017	1077	1132	1172	1232	1132	1157	1307

- Height-adjustable 20" diameter foot ring
- Upright tilt lock
- 3:1 back-to-seat tilt ratio
- Center knob tension control
- 360° swivel
- Pneumatic cylinder height adjustment

WIDTH: 24.5-26.0
DEPTH: 25.0
HEIGHT: 49.0-62.5
SEAT WIDTH: 20.0
SEAT DEPTH: 16.0-18.5
SEAT HEIGHT: 27.0-37.0
BACK WIDTH: 18.5
BACK HEIGHT: 23.0-25.5
COM: 0.9 YD
COL: 11.0 SQ FT
WEIGHT: 45.0 LB

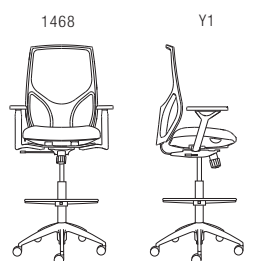

8" STOOL SIMPLE SYNCHRO TILT

Use for work surfaces up to 36" high

	T01	A	B/COM	C	D	E	F	G	L3/COL	L4	L5
A00	792	817	847	877	937	992	1032	1092	992	1017	1167
A6	952	977	1007	1037	1097	1152	1192	1252	1152	1177	1327
A7	967	992	1022	1052	1112	1167	1207	1267	1167	1192	1342
A8B/S	897	922	952	982	1042	1097	1137	1197	1097	1122	1272
A9B/S	907	932	962	992	1052	1107	1147	1207	1107	1132	1282
A10	902	927	957	987	1047	1102	1142	1202	1102	1127	1277
A36	917	942	972	1002	1062	1117	1157	1217	1117	1142	1292
A37	932	957	987	1017	1077	1132	1172	1232	1132	1157	1307

- Height-adjustable 20" diameter foot ring
- Upright tilt lock
- 3:1 back-to-seat tilt ratio
- Center knob tension control
- 360° swivel
- Pneumatic cylinder height adjustment

WIDTH: 24.5-26.0
DEPTH: 25.0
HEIGHT: 45.0-55.5
SEAT WIDTH: 20.0
SEAT DEPTH: 16.0-18.5
SEAT HEIGHT: 23.0-31.0
BACK WIDTH: 18.5
BACK HEIGHT: 23.0-25.5
COM: 0.9 YD
COL: 11.0 SQ FT
WEIGHT: 44.0 LB

ARM OPTIONS

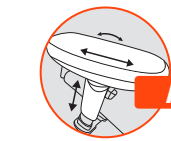

A6
\$160

Height Adjustable Pivot Slide Arm

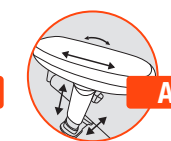

A7
\$175

Height/Width Adjustable Pivot Slide Arm



A8B/S
\$105

Height Adjustable Arm- A8B - Black A8S - Silver



A9B/S
\$115

Height/Width Adjustable Arm- A9B - Black A9S - Silver



A10
\$110

Soft Touch C-Shaped Arm



A36
\$125

Height Adjustable Pivot/Slide Arm



A37
\$140

Height/Width Adjustable Pivot/Slide Arm



A90
\$235

Height/Width Adjustable Breakaway Arm

CASTERS

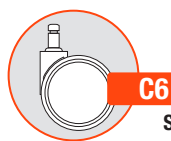

C6
STD

Large Diameter Carpet Casters



C6S
\$35

Large Diameter Hard Floor and Carpet Casters



C7
\$35

Chrome-Accented Hard Floor and Carpet Casters



EF1
\$30

1" Extra Foam on Seat. If EF1 is selected, cannot use MF1 in addition.



MF1
\$50

1" Visco Elastic Memory Foam on Seat. If MF1 is selected, cannot use EF1 in addition.

BASE OPTIONS



BA11B
STD

27" Mid-Profile Nylon Base BA11B - Black

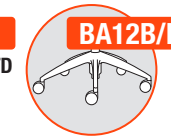

BA12B/P/S
\$110

27" Mid-Profile Aluminum Base BA12B - Black Powder Coat BA12P - Polished BA12S - Silver Powder Coat

MESH COLORS

M2	BLACK M21	GRAY M22	WHITE M23	GREEN M24
M2	RED M25	BLUE M26	ORANGE M27	AQUA M28

M4	LATTE M40	CLOUD M41	LEMON M42	APPLE M43	TANGERINE M44	CRIMSON M46
M4	ONYX M48	DOVE M49	AZURE M50	FEDERAL BLUE M51	WHITE WHISPER M52	

vault

goes beyond the expected

HIGH-BACK

GSA SIN # 33721

- Task, stool, conference and executive seating
- Ratchet back lumbar height adjustment
- Seat slider standard
- Warranted to 300 lbs.



CREATING VAULT MODEL NUMBER

MODEL NUMBER CONTROL ARMS BACK MESH COLOR GRADE BASE CASTERS PACKAGING OPTIONS

1 4 8 0 - [] [] - A [] [] - M [] [] - [] [] [] - B A [] [] - C [] [] - [] [] [] []

* FOR ARMLESS USE CODE A00 * IF BASE AND CASTER MODEL NUMBERS ARE LEFT BLANK THEN STANDARD OPTION WILL BE ASSUMED

PACKAGING NOTES

CODE	DESCRIPTION	LIST UPCHARGE
AB	ASSEMBLED IN BAG	\$0
PAC	PARTIALLY ASSEMBLED IN CARTON	\$0
BAC	BACK ASSEMBLED IN CARTON	\$80

MODEL	CONTROL	DESCRIPTION	ARM	FABRIC/LEATHER										
				T01	A	B/COM	C	D	E	F	G	L3/COL	L4	L5
1480	Y1	HIGH-BACK SIMPLE SYNCHRO TILT	A00	742	767	797	827	887	942	982	1042	942	967	1117
			A6	902	927	957	987	1047	1102	1142	1202	1102	1127	1277
			A7	917	942	972	1002	1062	1117	1157	1217	1117	1142	1292
			A8B/S	847	872	902	932	992	1047	1087	1147	1047	1072	1222
			A9B/S	857	882	912	942	1002	1057	1097	1157	1057	1082	1232
			A10	852	877	907	937	997	1052	1092	1152	1052	1077	1227
			A36	867	892	922	952	1012	1067	1107	1167	1067	1092	1242
A37	882	907	937	967	1027	1082	1122	1182	1082	1107	1257			

- ### FEATURES
- Upright tilt lock
 - 3:1 back-to-seat tilt ratio
 - Center knob tension adjustment
 - 360° swivel
 - Pneumatic cylinder height adjustment

DIMENSIONS

WIDTH: 26.0
 DEPTH: 26.0
 HEIGHT: 39.0-46.0
 SEAT WIDTH: 20.0
 SEAT DEPTH: 17.5
 SEAT HEIGHT: 17.5-22.5
 BACK WIDTH: 18.0
 BACK HEIGHT: 26.5-30.5
 COM: 0.8 YD
 COL: 11.0 SQ FT
 WEIGHT: 44.5 LB

ARM OPTIONS

A6
\$160

Height Adjustable Pivot Slide Arm

A7
\$175

Height/Width Adjustable Pivot Slide Arm

A8B/S
\$105

Height Adjustable Arm - A8B - Black A8S - Silver

A9B/S
\$115

Height/Width Adjustable Arm - A9B - Black A9S - Silver

CASTERS

C6
STD

Large Diameter Carpet Casters

C6S
\$35

Large Diameter Hard Floor and Carpet Casters

A10
\$110

Soft Touch C-Shaped Arm

A36
\$125

Height Adjustable Pivot/Slide Arm

C7
\$35

Chrome-Accented Hard Floor and Carpet Casters

MODEL	CONTROL	DESCRIPTION	ARM	FABRIC/LEATHER										
				T01	A	B/COM	C	D	E	F	G	L3/COL	L4	L5
1480	Y3	HIGH-BACK FULL SYNCHRO TILT	A00	802	827	857	887	947	1002	1042	1102	1002	1027	1177
			A6	962	987	1017	1047	1107	1162	1202	1262	1162	1187	1337
			A7	977	1002	1032	1062	1122	1177	1217	1277	1177	1202	1352
			A8B/S	907	932	962	992	1052	1107	1147	1207	1107	1132	1282
			A9B/S	917	942	972	1002	1062	1117	1157	1217	1117	1142	1292
			A10	912	937	967	997	1057	1112	1152	1212	1112	1137	1287
			A36	927	952	982	1012	1072	1127	1167	1227	1127	1152	1302
A37	942	967	997	1027	1087	1142	1182	1242	1142	1167	1317			

- ### FEATURES
- 3-position tilt lock
 - 2:1 back-to-seat tilt ratio
 - Center knob tension adjustment
 - 360° swivel
 - Pneumatic cylinder height adjustment

DIMENSIONS

WIDTH: 26.0
 DEPTH: 26.0
 HEIGHT: 39.0-46.0
 SEAT WIDTH: 20.0
 SEAT DEPTH: 17.5
 SEAT HEIGHT: 17.5-22.5
 BACK WIDTH: 18.0
 BACK HEIGHT: 26.5-30.5
 COM: 0.8 YD
 COL: 11.0 SQ FT
 WEIGHT: 46.5 LB

ARM OPTIONS

A37
\$140

Height/Width Adjustable Pivot/Slide Arm

A90
\$235

Height/Width Adjustable Breakaway Arm

ADDITIONAL OPTIONS

EF1
\$30

1" Extra Foam on Seat. If EF1 is selected, cannot use MF1 in addition.

MODEL	CONTROL	DESCRIPTION	ARM	FABRIC/LEATHER										
				T01	A	B/COM	C	D	E	F	G	L3/COL	L4	L5
1480	K2	HIGH-BACK ENHANCED KNEE TILT	A00	832	857	887	917	977	1032	1072	1132	1032	1057	1207
			A6	992	1017	1047	1077	1137	1192	1232	1292	1192	1217	1367
			A7	1007	1032	1062	1092	1152	1207	1247	1307	1207	1232	1382
			A8B/S	937	962	992	1022	1082	1137	1177	1237	1137	1162	1312
			A9B/S	947	972	1002	1032	1092	1147	1187	1247	1147	1172	1322
			A10	942	967	997	1027	1087	1142	1182	1242	1142	1167	1317
			A36	957	982	1012	1042	1102	1157	1197	1257	1157	1182	1332
A37	972	997	1027	1057	1117	1172	1212	1272	1172	1197	1347			

- ### FEATURES
- 4-position tilt lock
 - Side knob tension adjustment
 - 360° swivel
 - Pneumatic cylinder height adjustment

DIMENSIONS

WIDTH: 26.0
 DEPTH: 26.0
 HEIGHT: 44.0-53.0
 SEAT WIDTH: 20.0
 SEAT DEPTH: 17.5
 SEAT HEIGHT: 18.5-21.5
 BACK WIDTH: 18.0
 BACK HEIGHT: 26.5-30.5
 COM: 0.8 YD
 COL: 11.0 SQ FT
 WEIGHT: 46.5 LB

BASE OPTIONS

BA11B
STD

27" Mid-Profile Nylon Base BA11B - Black

BA12B/P/S
\$110

27" Mid-Profile Aluminum Base BA12B - Black Powder Coat BA12P - Polished BA12S - Silver Powder Coat

MF1
\$50

1" Visco Elastic Memory Foam on Seat. If MF1 is selected, cannot use EF1 in addition.

MESH COLORS

M2	BLACK M21	GRAY M22	WHITE M23	GREEN M24
M2	RED M25	BLUE M26	ORANGE M27	AQUA M28

M4	LATTE M40	CLOUD M41	LEMON M42	APPLE M43	TANGERINE M44	CRIMSON M46
M4	ONYX M48	DOVE M49	AZURE M50	FEDERAL BLUE M51	WHITE WHISPER M52	

VOX

contemporary stacking

GSA SIN # 33721 PENDING

- Stacking side, guest, task and stool
- Flexback movement
- All plastic, upholstered seat or upholstered back and seat
- Pull handle for easy mobility
- Warranted to 300 lbs.



CREATING VOX MODEL NUMBER

MODEL NUMBER CONTROL FRAME COLOR UPHOLSTERY PLASTIC COLOR CASTERS PACKAGING OPTIONS
1090 - GT - F - AP - P - C - A -

PACKAGING NOTES

CODE	DESCRIPTION	LIST UPCHARGE
AB	ASSEMBLED IN BAG	\$0
AC	ASSEMBLED IN CARTON	\$0

Nylon stacking chairs ship up to 3 per carton

MODEL	CONTROL	DESCRIPTION	ARM	PLASTIC	FEATURES	DIMENSIONS
1090	GT	4-LEG GUEST STACKING ARMLESS Plastic back with plastic seat	A00	P 302	<ul style="list-style-type: none"> • Stacks 4 high on the floor • Stacks 8 high on the optional stacking dolly • Arms and glides coordinate with the frame color • Non-marring glides standard 	WIDTH: 21.5 DEPTH: 21.0 HEIGHT: 34.0 SEAT WIDTH: 18.5 SEAT DEPTH: 16.0 SEAT HEIGHT: 18.5 BACK WIDTH: 18.0 BACK HEIGHT: 17.5 WEIGHT: 16.0 LB
1091	GT	4-LEG GUEST STACKING ARMED Plastic back with plastic seat	A53	P 357	<ul style="list-style-type: none"> • Stacks 4 high on the floor • Stacks 8 high on the optional stacking dolly • Arms and glides coordinate with the frame color • Non-marring glides standard 	WIDTH: 22.5 DEPTH: 21.0 HEIGHT: 34.0 SEAT WIDTH: 18.5 SEAT DEPTH: 16.0 SEAT HEIGHT: 33.0 BACK WIDTH: 18.0 BACK HEIGHT: 18.0 WEIGHT: 18.0 LB
1090	GT	4-LEG GUEST STACKING ARMLESS WITH CASTERS Plastic back with plastic seat	A00	P 347	<ul style="list-style-type: none"> • Stacks 4 high on the floor • Stacks 8 high on the optional stacking dolly • Arms and glides coordinate with the frame color 	WIDTH: 21.5 DEPTH: 21.0 HEIGHT: 34.0 SEAT WIDTH: 18.5 SEAT DEPTH: 16.0 BACK WIDTH: 18.0 BACK HEIGHT: 17.5 WEIGHT: 16.0 LB
1091	GT	4-LEG GUEST STACKING ARMED WITH CASTERS Plastic back with plastic seat	A53	P 402	<ul style="list-style-type: none"> • Stacks 4 high on the floor • Stacks 8 high on the optional stacking dolly • Arms and glides coordinate with the frame color 	WIDTH: 22.5 DEPTH: 21.0 HEIGHT: 34.0 SEAT WIDTH: 18.5 SEAT DEPTH: 16.0 SEAT HEIGHT: 33.0 BACK WIDTH: 18.0 BACK HEIGHT: 18.0 WEIGHT: 18.0 LB
1094	GT	SLED GUEST STACKING ARMLESS Plastic back with plastic seat	A00	P 279	<ul style="list-style-type: none"> • Stacks 7 high on the floor • Stacks 20 high on the optional stacking dolly • Arms and glides coordinate with the frame color • Optional glides available 	WIDTH: 21.5 DEPTH: 21.0 HEIGHT: 36.0 SEAT WIDTH: 18.5 SEAT DEPTH: 16.0 SEAT HEIGHT: 18.5 BACK WIDTH: 18.0 BACK HEIGHT: 17.5 WEIGHT: 16.0 LB
1095	GT	SLED GUEST STACKING ARMED Plastic back with plastic seat	A54	P 334	<ul style="list-style-type: none"> • Stacks 7 high on the floor • Stacks 20 high on the optional stacking dolly • Arms and glides coordinate with the frame color • Optional glides available 	WIDTH: 21.0 DEPTH: 36.0 HEIGHT: 18.5 SEAT WIDTH: 18.5 SEAT DEPTH: 16.0 SEAT HEIGHT: 18.5 BACK WIDTH: 18.0 BACK HEIGHT: 17.5 WEIGHT: 18.0 LB

CAUTION: Careless stacking of chairs may scratch and damage frames.

ARM OPTIONS



A53B/G
STD
Nylon Fixed Arm for 4 leg models
A53B - Black
A53G - Cloud Gray



A54B/G
STD
Nylon Fixed Arm for sled model
A54B - Black
A54G - Cloud Gray



C12S
STD
Hard Floor and Carpet Casters

ADDITIONAL OPTIONS



G16
\$15
Sled Base Clear Plastic Glide - 4 per set



G17
\$25
Sled Base Clear Plastic Glide with Felt - 4 per set



G21B/G
NC
Tapered Plastic Glide
G21B - Black
G21G - Gray



G21BN/GN
\$20
Swivel Nylon Glide
G21BN - Black Nylon
G21GN - Gray Nylon



G21BS/GS
\$20
Swivel Steel Glide
G21BS - Black Steel
G21GS - Gray Steel



G21BF/GF
\$20
Swivel Felt Glide
G21BF - Black Felt
G21GF - Gray Felt

ACCESSORIES

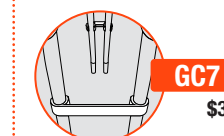

GC7
\$30
Ganging Clip-2 per set
For 4-leg models
Arm-to-Arm and Armless-to-Armless

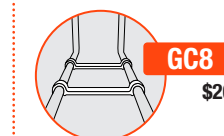

GC8
\$20
Ganging Clip-2 per set
For Sled models
Arm-to-Arm and Armless-to-Armless
2" Between Chairs when Ganged



DL5
\$399
Stacking Dolly
Stacks up to 8 High - 4-Leg Models
Stacks up to 20 High - Sled Models

Due to the nature of upholstery, stacking may cause impressions on the seat. 9to5 Seating does not warrant effects of stacking on upholstery.

FRAME COLORS

BLACK BF	SILVER SF
-------------	--------------

PLASTIC COLORS

BLACK SWAN P01	WHITE WHISPER P05	FEDERAL BLUE P11	CRIMSON RED P12
LEMON YELLOW P13	DOVE GRAY P14	CLOUD GRAY P15	LAGOON BLUE P16
APPLE GREEN P17	TANGERINE ORANGE P18	LATTE P19	AZURE BLUE P20

(BACK AND SEAT)

VOX

contemporary stacking

GSA SIN # 33721 PENDING

- Stacking side, guest, task and stool
- Flexback movement
- All plastic, upholstered seat or upholstered back and seat
- Pull handle for easy mobility
- Warranted to 300 lbs.



CREATING VOX MODEL NUMBER

MODEL NUMBER CONTROL FRAME COLOR UPHOLSTERY PLASTIC COLOR PACKAGING OPTIONS
1090-ST-00-F-AP-P-00-A-00-00

PACKAGING NOTES

CODE	DESCRIPTION	LIST UPCHARGE
AB	ASSEMBLED IN BAG	\$0
AC	ASSEMBLED IN CARTON	\$0

Vox stools ship 1 per carton

ALL PLASTIC - AP - STOOL

MODEL	CONTROL	DESCRIPTION	ARM	PLASTIC	FEATURES	DIMENSIONS
1090	ST24	24" COUNTER STOOL ARMLESS Plastic back with plastic seat	A00	P 432	<ul style="list-style-type: none"> • Stacks 4 high on the floor • Arms and glides coordinate with the frame color • Non-marring glides standard 	WIDTH: 21.5 DEPTH: 21.0 HEIGHT: 39.5 SEAT WIDTH: 18.5 SEAT DEPTH: 16.0 SEAT HEIGHT: 24.0 BACK WIDTH: 18.0 BACK HEIGHT: 17.5 WEIGHT: 21.5 LB
1091	ST24	24" COUNTER STOOL WITH ARMS Plastic back with plastic seat	A53	P 487	<ul style="list-style-type: none"> • Stacks 4 high on the floor • Arms and glides coordinate with the frame color • Non-marring glides standard 	WIDTH: 22.5 DEPTH: 21.0 HEIGHT: 39.5 SEAT WIDTH: 18.5 SEAT DEPTH: 16.0 SEAT HEIGHT: 24.0 BACK WIDTH: 18.0 BACK HEIGHT: 17.5 WEIGHT: 23.5 LB
1090	ST30	30" BAR STOOL ARMLESS Plastic back with plastic seat	A00	P 452	<ul style="list-style-type: none"> • Stacks 4 high on the floor • Arms and glides coordinate with the frame color • Non-marring glides standard 	WIDTH: 21.5 DEPTH: 21.0 HEIGHT: 45.5 SEAT WIDTH: 18.5 SEAT DEPTH: 16.0 SEAT HEIGHT: 30.0 BACK WIDTH: 18.0 BACK HEIGHT: 17.5 WEIGHT: 24.0 LB
1091	ST30	30" BAR STOOL WITH ARMS Plastic back with plastic seat	A53	P 507	<ul style="list-style-type: none"> • Stacks 4 high on the floor • Arms and glides coordinate with the frame color • Non-marring glides standard 	WIDTH: 22.5 DEPTH: 21.0 HEIGHT: 45.5 SEAT WIDTH: 18.5 SEAT DEPTH: 16.0 SEAT HEIGHT: 30.0 BACK WIDTH: 18.0 BACK HEIGHT: 17.5 WEIGHT: 26.0 LB

ARM OPTIONS



Nylon Fixed Arm for 4 leg models
 A53B - Black
 A53G - Cloud Gray

ADDITIONAL OPTIONS



Tapered Plastic Glide
 G21B - Black
 G21G - Gray



Swivel Nylon Glide
 G21BN - Black Nylon
 G21GN - Gray Nylon



Swivel Steel Glide
 G21BS - Black Steel
 G21GS - Gray Steel



Swivel Felt Glide
 G21BF - Black Felt
 G21GF - Gray Felt

FRAME COLORS

BLACK BF	SILVER SF
-------------	--------------

PLASTIC COLORS

BLACK SWAN P01	WHITE WHISPER P05	FEDERAL BLUE P11	CRIMSON RED P12	LEMON YELLOW P13	DOVE GRAY P14
CLOUD GRAY P15	LAGOON BLUE P16	APPLE GREEN P17	TANGERINE ORANGE P18	LATTE P19	AZURE BLUE P20

(BACK AND SEAT)

VOX

contemporary stacking

GSA SIN # 33721 PENDING

- Stacking side, guest, task and stool
- Flexback movement
- All plastic, upholstered seat or upholstered back and seat
- Pull handle for easy mobility
- Warranted to 300 lbs.



CREATING VOX MODEL NUMBER

MODEL NUMBER	CONTROL	FRAME COLOR	UPHOLSTERY	PLASTIC COLOR	CASTERS	PACKAGING	OPTIONS
1090	GT	F	U	S	P	C	A

PACKAGING NOTES

CODE	DESCRIPTION	LIST UPCHARGE
AB	ASSEMBLED IN BAG	\$0
AC	ASSEMBLED IN CARTON	\$0

Vox stacking chairs ship up to 3 per carton

MODEL	CONTROL	DESCRIPTION	ARM	FABRIC/LEATHER	FEATURES	DIMENSIONS			
							A	B/COM	C
1090	GT	4-LEG GUEST STACKING ARMLESS Plastic back with upholstered seat	A00		<ul style="list-style-type: none"> • Stacks 4 high on the floor • Stacks 8 high on the optional stacking dolly • Arms and glides coordinate with the frame color • Non-marring glides standard 	WIDTH: 21.5 DEPTH: 21.0 HEIGHT: 34.0 SEAT WIDTH: 18.5 SEAT DEPTH: 16.0 SEAT HEIGHT: 18.5 BACK WIDTH: 18.0 BACK HEIGHT: 17.5 COM: 0.5 YD COL: 3.91 SQ FT WEIGHT: 16.0 LB			
1091	GT	4-LEG GUEST STACKING ARMED Plastic back with upholstered seat	A53		<ul style="list-style-type: none"> • Stacks 4 high on the floor • Stacks 8 high on the optional stacking dolly • Arms and glides coordinate with the frame color • Non-marring glides standard 	WIDTH: 22.5 DEPTH: 21.0 HEIGHT: 34.0 SEAT WIDTH: 18.5 SEAT DEPTH: 16.0 SEAT HEIGHT: 33.0 BACK WIDTH: 18.0 BACK HEIGHT: 18.0 COM: 0.5 YD COL: 3.91 SQ FT WEIGHT: 18.0 LB			
1090	GT	4-LEG GUEST STACKING ARMLESS WITH CASTERS Plastic back with upholstered seat	A00		<ul style="list-style-type: none"> • Stacks 4 high on the floor • Stacks 8 high on the optional stacking dolly • Arms and glides coordinate with the frame color 	WIDTH: 21.5 DEPTH: 21.0 HEIGHT: 34.0 SEAT WIDTH: 18.5 SEAT DEPTH: 16.0 SEAT HEIGHT: 18.5 BACK WIDTH: 18.0 BACK HEIGHT: 17.5 COM: 0.5 YD COL: 3.91 SQ FT WEIGHT: 16.0 LB			
1091	GT	4-LEG GUEST STACKING ARMED WITH CASTERS Plastic back with upholstered seat	A53		<ul style="list-style-type: none"> • Stacks 4 high on the floor • Stacks 8 high on the optional stacking dolly • Arms and glides coordinate with the frame color 	WIDTH: 22.5 DEPTH: 21.0 HEIGHT: 34.0 SEAT WIDTH: 18.5 SEAT DEPTH: 16.0 SEAT HEIGHT: 33.0 BACK WIDTH: 18.0 BACK HEIGHT: 18.0 COM: 0.5 YD COL: 3.91 SQ FT WEIGHT: 18.0 LB			
1094	GT	SLED GUEST STACKING ARMLESS Plastic back with upholstered seat	A00		<ul style="list-style-type: none"> • Stacks 7 high on the floor • Stacks 20 high on the optional stacking dolly • Arms and glides coordinate with the frame color • Optional glides available 	WIDTH: 21.5 DEPTH: 21.0 HEIGHT: 36.0 SEAT WIDTH: 18.5 SEAT DEPTH: 16.0 SEAT HEIGHT: 18.5 BACK WIDTH: 18.0 BACK HEIGHT: 17.5 COM: 0.5 YD COL: 3.91 SQ FT WEIGHT: 16.0 LB			
1095	GT	SLED GUEST STACKING ARMED Plastic back with upholstered seat	A54		<ul style="list-style-type: none"> • Stacks 7 high on the floor • Stacks 20 high on the optional stacking dolly • Arms and glides coordinate with the frame color • Optional glides available 	WIDTH: 21.5 DEPTH: 21.0 HEIGHT: 36.0 SEAT WIDTH: 18.5 SEAT DEPTH: 16.0 SEAT HEIGHT: 18.5 BACK WIDTH: 18.0 BACK HEIGHT: 17.5 COM: 0.5 YD COL: 3.91 SQ FT WEIGHT: 18.0 LB			

CAUTION: Careless stacking of chairs may scratch and damage frames.

ARM OPTIONS

A53B/G
STD
Nylon Fixed Arm for 4 leg models
A53B - Black
A53G - Cloud Gray

A54B/G
STD
Nylon Fixed Arm for sled models
A54B - Black
A54G - Cloud Gray

C12S
STD
Hard Floor and Carpet Casters

ADDITIONAL OPTIONS

G16
\$15
Sled Base Clear Plastic Glide - 4 per set

G17
\$25
Sled Base Clear Plastic Glide with Felt - 4 per set

G21B/G
NC
Tapered Plastic Glide
G21B - Black
G21G - Gray

G21BN/GN
\$20
Swivel Nylon Glide
G21BN - Black Nylon
G21GN - Gray Nylon

G21BS/GS
\$20
Swivel Steel Glide
G21BS - Black Steel
G21GS - Gray Steel

G21BF/GF
\$20
Swivel Felt Glide
G21BF - Black Felt
G21GF - Gray Felt

ACCESSORIES

GC7
\$30
Ganging Clip-2 per set
For 4-leg models
Arm-to-Arm and Armless-to-Armless

GC8
\$20
Ganging Clip-2 per set
For Sled models
Arm-to-Arm and Armless-to-Armless
2" Between Chairs when Ganged

DL5
\$399
Stacking Dolly
Stacks up to 8 High - 4-Leg Models
Stacks up to 20 High - Sled Models

FRAME COLORS

BLACK BF	SILVER SF
-------------	--------------

PLASTIC COLORS

BLACK SWAN P01	WHITE WHISPER P05	FEDERAL BLUE P11	CRIMSON RED P12
LEMON YELLOW P13	DOVE GRAY P14	CLOUD GRAY P15	LAGOON BLUE P16
APPLE GREEN P17	TANGERINE ORANGE P18	LATTE P19	AZURE BLUE P20

(BACK AND SEAT)

VOX

contemporary stacking

GSA SIN # 33721 PENDING

- Stacking side, guest, task and stool
- Flexback movement
- All plastic, upholstered seat or upholstered back and seat
- Pull handle for easy mobility
- Warranted to 300 lbs.



CREATING VOX MODEL NUMBER

MODEL NUMBER CONTROL FRAME COLOR UPHOLSTERY PLASTIC COLOR PACKAGING OPTIONS
1090-ST-FF-US-PA

PACKAGING NOTES

CODE	DESCRIPTION	LIST UPCHARGE
AB	ASSEMBLED IN BAG	\$0
AC	ASSEMBLED IN CARTON	\$0

Vox stools ship 1 per carton

UPHOLSTERED SEAT - US - STOOL

MODEL	CONTROL	DESCRIPTION	ARM	FABRIC/LEATHER											FEATURES	DIMENSIONS						
				A	B/COM	C	D	E	F	G	L3/COL	L4	L5	WIDTH:		DEPTH:	HEIGHT:	SEAT WIDTH:	SEAT DEPTH:	SEAT HEIGHT:	BACK WIDTH:	BACK HEIGHT:
1090	ST24	24" COUNTER STOOL ARMLESS Plastic back with upholstered seat	A00	486	508	531	561	596	631	661	636	686	756	<ul style="list-style-type: none"> • Stacks 4 high on the floor • Arms and glides coordinate with the frame color • Non-marring glides standard 	WIDTH: 21.5 DEPTH: 21.0 HEIGHT: 39.5 SEAT WIDTH: 18.5 SEAT DEPTH: 16.0 SEAT HEIGHT: 24.0 BACK WIDTH: 18.0 BACK HEIGHT: 17.5 COM: 0.5 YD COL: 3.91 SQ FT WEIGHT: 21.5 LB							
1091	ST24	24" COUNTER STOOL WITH ARMS Plastic back with upholstered seat	A53	541	563	586	616	651	686	716	691	741	811	<ul style="list-style-type: none"> • Stacks 4 high on the floor • Arms and glides coordinate with the frame color • Non-marring glides standard 	WIDTH: 22.5 DEPTH: 21.0 HEIGHT: 39.5 SEAT WIDTH: 18.5 SEAT DEPTH: 16.0 SEAT HEIGHT: 24.0 BACK WIDTH: 18.0 BACK HEIGHT: 17.5 COM: 0.5 YD COL: 3.91 SQ FT WEIGHT: 23.5 LB							
1090	ST30	30" BAR STOOL ARMLESS Plastic back with upholstered seat	A00	506	528	551	581	616	651	681	656	706	776	<ul style="list-style-type: none"> • Stacks 4 high on the floor • Arms and glides coordinate with the frame color • Non-marring glides standard 	WIDTH: 21.5 DEPTH: 21.0 HEIGHT: 45.5 SEAT WIDTH: 18.5 SEAT DEPTH: 16.0 SEAT HEIGHT: 30.0 BACK WIDTH: 18.0 BACK HEIGHT: 17.5 COM: 0.5 YD COL: 3.91 SQ FT WEIGHT: 24.0 LB							
1091	ST30	30" BAR STOOL WITH ARMS Plastic back with upholstered seat	A53	561	583	606	636	671	706	736	711	761	831	<ul style="list-style-type: none"> • Stacks 4 high on the floor • Arms and glides coordinate with the frame color • Non-marring glides standard 	WIDTH: 22.5 DEPTH: 21.0 HEIGHT: 45.5 SEAT WIDTH: 18.5 SEAT DEPTH: 16.0 SEAT HEIGHT: 30.0 BACK WIDTH: 18.0 BACK HEIGHT: 17.5 COM: 0.5 YD COL: 3.91 SQ FT WEIGHT: 26.0 LB							

ARM OPTIONS



A53B/G
STD
Nylon Fixed Arm for 4 leg models
A53B - Black
A53G - Cloud Gray

ADDITIONAL OPTIONS



G21B/G
NC
Tapered Plastic Glide
G21B - Black
G21G - Gray



G21BN/GN
\$20
Swivel Nylon Glide
G21BN - Black Nylon
G21GN - Gray Nylon



G21BS/GS
\$20
Swivel Steel Glide
G21BS - Black Steel
G21GS - Gray Steel



G21BF/GF
\$20
Swivel Felt Glide
G21BF - Black Felt
G21GF - Gray Felt

FRAME COLORS

BLACK BF	SILVER SF
-------------	--------------

PLASTIC COLORS

BLACK SWAN P01	WHITE WHISPER P05	FEDERAL BLUE P11	CRIMSON RED P12	LEMON YELLOW P13	DOVE GRAY P14
CLOUD GRAY P15	LAGOON BLUE P16	APPLE GREEN P17	TANGERINE ORANGE P18	LATTE P19	AZURE BLUE P20

(BACK AND SEAT)

VOX

contemporary stacking

GSA SIN # 33721 PENDING

- Stacking side, guest, task and stool
- Flexback movement
- All plastic, upholstered seat or upholstered back and seat
- Pull handle for easy mobility
- Warranted to 300 lbs.



CREATING VOX MODEL NUMBER

MODEL NUMBER	CONTROL	FRAME COLOR	UPHOLSTERY	PLASTIC COLOR	CASTERS	PACKAGING	OPTIONS
1090	GT	F	UP	P	C	A	

PACKAGING NOTES

CODE	DESCRIPTION	LIST UPCHARGE
AB	ASSEMBLED IN BAG	\$0
AC	ASSEMBLED IN CARTON	\$0

Vox stacking chairs ship up to 3 per carton

FULLY UPHOLSTERED - UP - GUEST

MODEL	CONTROL	DESCRIPTION	ARM	FABRIC/LEATHER											FEATURES	DIMENSIONS	ARM OPTIONS	CASTER OPTIONS	ADDITIONAL OPTIONS	ACCESSORIES			
				A	B/COM	C	D	E	F	G	L3/COL	L4	L5										
1090	GT	4-LEG GUEST STACKING ARMLESS Upholstered back with upholstered seat	A00	410	440	460	495	525	560	595	570	620	690	<ul style="list-style-type: none"> • Stacks 4 high on the floor • Stacks 8 high on the optional stacking dolly • Arms and glides coordinate with the frame color • Non-marring glides standard 	WIDTH: 21.5 DEPTH: 21.0 HEIGHT: 34.0 SEAT WIDTH: 18.5 SEAT DEPTH: 16.0 SEAT HEIGHT: 18.5 BACK WIDTH: 18.0 BACK HEIGHT: 17.5 COM: 1.0 YD COL: 7.82 SQ FT WEIGHT: 16.0 LB	A53B/G STD Nylon Fixed Arm for 4 leg models A53B - Black A53G - Cloud Gray	A54B/G STD Nylon Fixed Arm for sled models A54B - Black A54G - Cloud Gray	C12S STD Hard Floor and Carpet Casters					
1091	GT	4-LEG GUEST STACKING ARMED Upholstered back with upholstered seat	A53	465	495	515	550	580	615	650	625	675	745	<ul style="list-style-type: none"> • Stacks 4 high on the floor • Stacks 8 high on the optional stacking dolly • Arms and glides coordinate with the frame color • Non-marring glides standard 	WIDTH: 22.5 DEPTH: 21.0 HEIGHT: 34.0 SEAT WIDTH: 18.5 SEAT DEPTH: 16.0 SEAT HEIGHT: 33.0 BACK WIDTH: 18.0 BACK HEIGHT: 17.5 COM: 1.0 YD COL: 7.82 SQ FT WEIGHT: 18.0 LB								
1090	GT	4-LEG GUEST STACKING ARMLESS WITH CASTERS Upholstered back with upholstered seat	A00	455	485	505	540	570	605	640	615	665	735	<ul style="list-style-type: none"> • Stacks 4 high on the floor • Stacks 8 high on the optional stacking dolly • Arms and glides coordinate with the frame color 	WIDTH: 21.5 DEPTH: 21.0 HEIGHT: 34.0 SEAT WIDTH: 18.5 SEAT DEPTH: 16.0 SEAT HEIGHT: 18.5 BACK WIDTH: 18.0 BACK HEIGHT: 17.5 COM: 1.0 YD COL: 7.82 SQ FT WEIGHT: 16.0 LB								
1091	GT	4-LEG GUEST STACKING ARMED WITH CASTERS Upholstered back with upholstered seat	A53	510	540	560	595	625	660	695	670	720	790	<ul style="list-style-type: none"> • Stacks 4 high on the floor • Stacks 8 high on the optional stacking dolly • Arms and glides coordinate with the frame color 	WIDTH: 22.5 DEPTH: 21.0 HEIGHT: 34.0 SEAT WIDTH: 18.5 SEAT DEPTH: 16.0 SEAT HEIGHT: 33.0 BACK WIDTH: 18.0 BACK HEIGHT: 17.5 COM: 1.0 YD COL: 7.82 SQ FT WEIGHT: 18.0 LB								
1094	GT	SLED COUNTER STOOL ARMLESS Upholstered back with upholstered seat	A00	387	417	437	472	502	537	572	547	597	667	<ul style="list-style-type: none"> • Stacks 7 high on the floor • Stacks 20 high on the optional stacking dolly • Optional glides available 	WIDTH: 21.5 DEPTH: 21.0 HEIGHT: 36.0 SEAT WIDTH: 18.5 SEAT DEPTH: 16.0 SEAT HEIGHT: 18.5 BACK WIDTH: 18.0 BACK HEIGHT: 17.5 COM: 1.0 YD COL: 7.82 SQ FT WEIGHT: 16.0 LB								
1095	GT	SLED GUEST STACKING ARMED Upholstered back with upholstered seat	A54	442	472	492	527	557	592	627	602	652	722	<ul style="list-style-type: none"> • Stacks 7 high on the floor • Stacks 20 high on the optional stacking dolly • Arms and glides coordinate with the frame color • Optional glides available 	WIDTH: 21.5 DEPTH: 21.0 HEIGHT: 36.0 SEAT WIDTH: 18.5 SEAT DEPTH: 16.0 SEAT HEIGHT: 18.5 BACK WIDTH: 18.0 BACK HEIGHT: 17.5 COM: 1.0 YD COL: 7.82 SQ FT WEIGHT: 18.0 LB								

CAUTION: Careless stacking of chairs may scratch and damage frames.

FRAME COLORS

BLACK BF	SILVER SF
-------------	--------------

PLASTIC COLORS

BLACK SWAN P01	WHITE WHISPER P05	FEDERAL BLUE P11	CRIMSON RED P12
LEMON YELLOW P13	DOVE GRAY P14	CLOUD GRAY P15	LAGOON BLUE P16
APPLE GREEN P17	TANGERINE ORANGE P18	LATTE P19	AZURE BLUE P20

(BACK AND SEAT)

Due to the nature of upholstery, stacking may cause impressions on the seat. 9to5 Seating does not warrant effects of stacking on upholstery.

VOX

contemporary stacking

GSA SIN # 33721 PENDING

- Stacking side, guest, task and stool
- Flexback movement
- All plastic, upholstered seat or upholstered back and seat
- Pull handle for easy mobility
- Warranted to 300 lbs.



CREATING VOX MODEL NUMBER

MODEL NUMBER CONTROL FRAME COLOR UPHOLSTERY PLASTIC COLOR PACKAGING OPTIONS

1 0 9 - S T - F - U P - P - A - - -

PACKAGING NOTES

CODE	DESCRIPTION	LIST UPCHARGE
AB	ASSEMBLED IN BAG	\$0
AC	ASSEMBLED IN CARTON	\$0

Vox stools ship 1 per carton

FULLY UPHOLSTERED - UP - STOOL

MODEL	CONTROL	DESCRIPTION	ARM	FABRIC/LEATHER	FEATURES	DIMENSIONS																				
1090	ST24	24" COUNTER STOOL ARMLESS Upholstered back with upholstered seat	A00	<table border="1"> <thead> <tr> <th>A</th> <th>B/COM</th> <th>C</th> <th>D</th> <th>E</th> <th>F</th> <th>G</th> <th>L3/COL</th> <th>L4</th> <th>L5</th> </tr> </thead> <tbody> <tr> <td>540</td> <td>570</td> <td>590</td> <td>625</td> <td>655</td> <td>690</td> <td>725</td> <td>700</td> <td>750</td> <td>820</td> </tr> </tbody> </table>	A	B/COM	C	D	E	F	G	L3/COL	L4	L5	540	570	590	625	655	690	725	700	750	820	<ul style="list-style-type: none"> • Stacks 4 high on the floor • Arms and glides coordinate with the frame color • Non-marring glides standard 	WIDTH: 21.5 DEPTH: 21.0 HEIGHT: 39.5 SEAT WIDTH: 18.5 SEAT DEPTH: 16.0 SEAT HEIGHT: 24.0 BACK WIDTH: 18.0 BACK HEIGHT: 17.5 COM: 1.0 YD COL: 7.82 SQ FT WEIGHT: 21.5 LB
A	B/COM	C	D	E	F	G	L3/COL	L4	L5																	
540	570	590	625	655	690	725	700	750	820																	
1091	GT24	24" COUNTER STOOL WITH ARMS Upholstered back with upholstered seat	A53	<table border="1"> <thead> <tr> <th>A</th> <th>B/COM</th> <th>C</th> <th>D</th> <th>E</th> <th>F</th> <th>G</th> <th>L3/COL</th> <th>L4</th> <th>L5</th> </tr> </thead> <tbody> <tr> <td>595</td> <td>625</td> <td>645</td> <td>680</td> <td>710</td> <td>745</td> <td>780</td> <td>755</td> <td>805</td> <td>875</td> </tr> </tbody> </table>	A	B/COM	C	D	E	F	G	L3/COL	L4	L5	595	625	645	680	710	745	780	755	805	875	<ul style="list-style-type: none"> • Stacks 4 high on the floor • Arms and glides coordinate with the frame color • Non-marring glides standard 	WIDTH: 22.5 DEPTH: 21.0 HEIGHT: 39.5 SEAT WIDTH: 18.5 SEAT DEPTH: 16.0 SEAT HEIGHT: 24.0 BACK WIDTH: 18.0 BACK HEIGHT: 17.5 COM: 1.0 YD COL: 7.82 SQ FT WEIGHT: 23.5 LB
A	B/COM	C	D	E	F	G	L3/COL	L4	L5																	
595	625	645	680	710	745	780	755	805	875																	
1090	ST30	30" BAR STOOL ARMLESS Upholstered back with upholstered seat	A00	<table border="1"> <thead> <tr> <th>A</th> <th>B/COM</th> <th>C</th> <th>D</th> <th>E</th> <th>F</th> <th>G</th> <th>L3/COL</th> <th>L4</th> <th>L5</th> </tr> </thead> <tbody> <tr> <td>560</td> <td>590</td> <td>610</td> <td>645</td> <td>675</td> <td>710</td> <td>745</td> <td>720</td> <td>770</td> <td>840</td> </tr> </tbody> </table>	A	B/COM	C	D	E	F	G	L3/COL	L4	L5	560	590	610	645	675	710	745	720	770	840	<ul style="list-style-type: none"> • Stacks 4 high on the floor • Arms and glides coordinate with the frame color • Non-marring glides standard 	WIDTH: 21.5 DEPTH: 21.0 HEIGHT: 45.5 SEAT WIDTH: 18.5 SEAT DEPTH: 16.0 SEAT HEIGHT: 30.0 BACK WIDTH: 18.0 BACK HEIGHT: 17.5 COM: 1.0 YD COL: 7.82 SQ FT WEIGHT: 24.0 LB
A	B/COM	C	D	E	F	G	L3/COL	L4	L5																	
560	590	610	645	675	710	745	720	770	840																	
1091	ST30	30" BAR STOOL WITH ARMS Upholstered back with upholstered seat	A53	<table border="1"> <thead> <tr> <th>A</th> <th>B/COM</th> <th>C</th> <th>D</th> <th>E</th> <th>F</th> <th>G</th> <th>L3/COL</th> <th>L4</th> <th>L5</th> </tr> </thead> <tbody> <tr> <td>615</td> <td>645</td> <td>665</td> <td>700</td> <td>730</td> <td>765</td> <td>800</td> <td>775</td> <td>825</td> <td>895</td> </tr> </tbody> </table>	A	B/COM	C	D	E	F	G	L3/COL	L4	L5	615	645	665	700	730	765	800	775	825	895	<ul style="list-style-type: none"> • Stacks 4 high on the floor • Arms and glides coordinate with the frame color • Non-marring glides standard 	WIDTH: 22.5 DEPTH: 21.0 HEIGHT: 45.5 SEAT WIDTH: 18.5 SEAT DEPTH: 16.0 SEAT HEIGHT: 30.0 BACK WIDTH: 18.0 BACK HEIGHT: 17.5 COM: 1.0 YD COL: 7.82 SQ FT WEIGHT: 26.0 LB
A	B/COM	C	D	E	F	G	L3/COL	L4	L5																	
615	645	665	700	730	765	800	775	825	895																	

ARM OPTIONS



ADDITIONAL OPTIONS

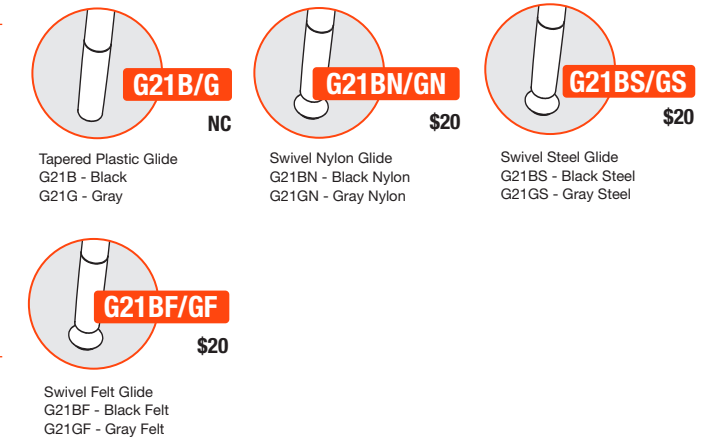

FRAME COLORS

BLACK BF	SILVER SF
-------------	--------------

PLASTIC COLORS

BLACK SWAN P01	WHITE WHISPER P05	FEDERAL BLUE P11	CRIMSON RED P12	LEMON YELLOW P13	DOVE GRAY P14
CLOUD GRAY P15	LAGOON BLUE P16	APPLE GREEN P17	TANGERINE ORANGE P18	LATTE P19	AZURE BLUE P20

(BACK AND SEAT)

VOX

contemporary stacking

GSA SIN # 33721 PENDING

- Stacking side, guest, task and stool
- Flexback movement
- All plastic, upholstered seat or upholstered back and seat
- Pull handle for easy mobility
- Warranted to 300 lbs.



CREATING VOX MODEL NUMBER

MODEL NUMBER CONTROL FRAME COLOR UPHOLSTERY PLASTIC COLOR BASE CASTERS PACKAGING

1 0 9 - - F - A P - P - - - C - - -

PACKAGING NOTES

CODE	DESCRIPTION	LIST UPCHARGE
AB	ASSEMBLED IN BAG	\$0
BAC	BACK ASSEMBLED IN CARTON	\$0

Vox stools ship 1 per carton

ALL PLASTIC - AP - TASK

MODEL	CONTROL	DESCRIPTION	ARM	PLASTIC	FEATURES	DIMENSIONS
1092	B1	BASIC TASK ARMLESS Plastic back with plastic seat	A00	P 427	<ul style="list-style-type: none"> • 360° swivel • Pneumatic cylinder height adjustment • Stool options available for \$125 upcharge. See stool option section. 	WIDTH: 26.5 DEPTH: 26.5 HEIGHT: 33.5 SEAT WIDTH: 18.5 SEAT DEPTH: 16.0 SEAT HEIGHT: 16.0-20.5 BACK WIDTH: 18.0 BACK HEIGHT: 17.5 WEIGHT: 28.0 LB
1093	B1	BASIC TASK ARMED Plastic back with plastic seat	A53	P 482	<ul style="list-style-type: none"> • 360° swivel • Pneumatic cylinder height adjustment • Stool options available for \$125 upcharge. See stool option section. 	WIDTH: 26.5 DEPTH: 26.5 HEIGHT: 33.5 SEAT WIDTH: 18.5 SEAT DEPTH: 16.0 SEAT HEIGHT: 16.0-20.5 BACK WIDTH: 18.0 BACK HEIGHT: 17.5 WEIGHT: 30.0 LB
1092	S3	SWIVEL TILT ARMLESS Plastic back with plastic seat	A00	P 462	<ul style="list-style-type: none"> • Upright lock • Center knob tension adjustment • 360° swivel • Pneumatic cylinder height adjustment • Stool options available for \$125 upcharge. See stool option section. 	WIDTH: 26.5 DEPTH: 26.5 HEIGHT: 34.0 SEAT WIDTH: 18.5 SEAT DEPTH: 16.0 SEAT HEIGHT: 16.5-21.0 BACK WIDTH: 18.0 BACK HEIGHT: 17.5 WEIGHT: 17.5 LB
1093	S3	SWIVEL TILT ARMED Plastic back with plastic seat	A53	P 517	<ul style="list-style-type: none"> • Upright lock • Center knob tension adjustment • 360° swivel • Pneumatic cylinder height adjustment • Arms coordinate with the frame color • Stool options available for \$125 upcharge. See stool option section. 	WIDTH: 26.5 DEPTH: 26.5 HEIGHT: 34.0 SEAT WIDTH: 18.5 SEAT DEPTH: 16.0 SEAT HEIGHT: 16.5-21.0 BACK WIDTH: 18.0 BACK HEIGHT: 17.5 WEIGHT: 19.5 LB

ARM OPTIONS



Nylon Fixed Arm for 4 leg models
A53B - Black
A53G - Cloud Gray

CASTER OPTIONS

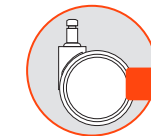

Large Diameter Carpet Casters

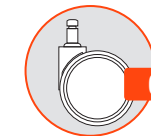

Large Diameter Hard Floor and Carpet Casters

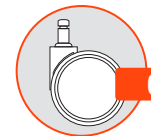

Chrome-Accented Hard Floor and Carpet Casters

BASE OPTIONS



27" Mid-Profile Nylon Base
BA11B - Black



27" Mid-Profile Aluminum Base
BA12B - Black
BA12P - Polished
BA12S - Silver
(C7 Chrome-Accented Casters Standard with Polished Base)

STOOL OPTIONS



CY30B - 8" Stool
(Seat Height: 22"-30")
Use for work surfaces up to 36"



CY36B - 10" Stool
(Seat Height: 25"-36")
Use for work surfaces up to 42"

FRAME COLORS

BLACK BF	SILVER SF
-------------	--------------

PLASTIC COLORS

BLACK SWAN P01	WHITE WHISPER P05	FEDERAL BLUE P11	CRIMSON RED P12
LEMON YELLOW P13	DOVE GRAY P14	CLOUD GRAY P15	LAGOON BLUE P16
APPLE GREEN P17	TANGERINE ORANGE P18	LATTE P19	AZURE BLUE P20

(BACK AND SEAT)

VOX

contemporary stacking

GSA SIN # 33721 PENDING

- Stacking side, guest, task and stool
- Flexback movement
- All plastic, upholstered seat or upholstered back and seat
- Pull handle for easy mobility
- Warranted to 300 lbs.



CREATING VOX MODEL NUMBER

MODEL NUMBER CONTROL FRAME COLOR UPHOLSTERY PLASTIC COLOR BASE CASTERS PACKAGING
1 0 9 - - **F** - **A** **P** - **P** - - - - **C** - - - -

PACKAGING NOTES

CODE	DESCRIPTION	LIST UPCHARGE
AB	ASSEMBLED IN BAG	\$0
BAC	BACK ASSEMBLED IN CARTON	\$0

Vox stools ship 1 per carton

ALL PLASTIC - AP - TASK

MODEL	CONTROL	DESCRIPTION	ARM	PLASTIC	FEATURES	DIMENSIONS
1092	R2	ROCKING TILT ARMLESS Plastic back with plastic seat	A00	P 517	<ul style="list-style-type: none"> • Rock left, right, front and back • 360° swivel • Pneumatic cylinder height adjustment • Stool options available for \$125 upcharge. See stool option section. 	WIDTH: 26.5 DEPTH: 26.5 HEIGHT: 35.0 SEAT WIDTH: 18.5 SEAT DEPTH: 16.0 SEAT HEIGHT: 17.0-21.5 BACK WIDTH: 18.0 BACK HEIGHT: 17.5 WEIGHT: 24.5 LB
1093	R2	ROCKING TILT ARMED Plastic back with plastic seat	A53	P 572	<ul style="list-style-type: none"> • Rock left, right, front and back • 360° swivel • Pneumatic cylinder height adjustment • Arms coordinate with the frame color • Stool options available for \$125 upcharge. See stool option section. 	WIDTH: 26.5 DEPTH: 26.5 HEIGHT: 35.0 SEAT WIDTH: 18.5 SEAT DEPTH: 16.0 SEAT HEIGHT: 17.0-21.5 BACK WIDTH: 18.0 BACK HEIGHT: 17.5 WEIGHT: 26.5 LB

ARM OPTIONS



Nylon Fixed Arm for 4 leg models
 A53B - Black
 A53G - Cloud Gray

CASTER OPTIONS

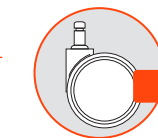

Large Diameter Carpet Casters

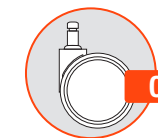

Large Diameter Hard Floor and Carpet Casters



Chrome-Accented Hard Floor and Carpet Casters

BASE OPTIONS



27" Mid-Profile Nylon Base
 BA11B - Black



27" Mid-Profile Aluminum Base
 BA12B - Black
 BA12P - Polished
 BA12S - Silver
 (C7 Chrome-Accented Casters Standard with Polished Base)

STOOL OPTIONS



CY30B - 8" Stool
 (Seat Height: 22"-30")
 Use for work surfaces up to 36"



CY36B - 10" Stool
 (Seat Height: 25"-36")
 Use for work surfaces up to 42"

FRAME COLORS

BLACK BF	SILVER SF
-------------	--------------

PLASTIC COLORS

BLACK SWAN P01	WHITE WHISPER P05	FEDERAL BLUE P11	CRIMSON RED P12
LEMON YELLOW P13	DOVE GRAY P14	CLOUD GRAY P15	LAGOON BLUE P16
APPLE GREEN P17	TANGERINE ORANGE P18	LATTE P19	AZURE BLUE P20

(BACK AND SEAT)

251

VOX

contemporary stacking

GSA SIN # 33721 PENDING

- Stacking side, guest, task and stool
- Flexback movement
- All plastic, upholstered seat or upholstered back and seat
- Pull handle for easy mobility
- Warranted to 300 lbs.



CREATING VOX MODEL NUMBER

MODEL NUMBER CONTROL FRAME COLOR UPHOLSTERY PLASTIC COLOR BASE CASTERS PACKAGING
109 - **F** - **U** - **S** - **P** - **C**

PACKAGING NOTES

CODE	DESCRIPTION	LIST UPCHARGE
AB	ASSEMBLED IN BAG	\$0
BAC	BACK ASSEMBLED IN CARTON	\$0

Vox stools ship 1 per carton

UPHOLSTERED SEAT - US - TASK

MODEL	CONTROL	DESCRIPTION	ARM	FABRIC/LEATHER											FEATURES	DIMENSIONS
				A	B/COM	C	D	E	F	G	L3/COL	L4	L5			
1092	B1	BASIC TASK ARMLESS Plastic Back & Upholstered Seat	A00	481	503	526	556	591	626	656	631	681	751	<ul style="list-style-type: none"> • 360° swivel • Pneumatic cylinder height adjustment • Stool options available for \$125 upcharge. See stool option section. 	WIDTH: 26.5 DEPTH: 26.5 HEIGHT: 33.5 SEAT WIDTH: 18.5 SEAT DEPTH: 16.0 SEAT HEIGHT: 16.0-20.5 BACK WIDTH: 18.0 BACK HEIGHT: 17.5 COM: 0.5 YD COL: 3.91 SQ FT WEIGHT: 28.0 LB	
1093	B1	BASIC TASK ARMED Plastic Back & Upholstered Seat	A53	536	558	581	611	646	681	711	686	736	806	<ul style="list-style-type: none"> • 360° swivel • Pneumatic cylinder height adjustment • Arms coordinate with the frame color • Stool options available for \$125 upcharge. See stool option section. 	WIDTH: 26.5 DEPTH: 26.5 HEIGHT: 33.5 SEAT WIDTH: 18.5 SEAT DEPTH: 16.0 SEAT HEIGHT: 16.0-20.5 BACK WIDTH: 18.0 BACK HEIGHT: 17.5 COM: 0.5 YD COL: 3.91 SQ FT WEIGHT: 30.0 LB	
1092	S3	SWIVEL TILT ARMLESS Plastic Back & Upholstered Seat	A00	516	538	561	591	626	661	691	666	716	786	<ul style="list-style-type: none"> • Upright lock • Center knob tension adjustment • 360° swivel • Pneumatic cylinder height adjustment • Stool options available for \$125 upcharge. See stool option section. 	WIDTH: 26.5 DEPTH: 26.5 HEIGHT: 34.0 SEAT WIDTH: 18.5 SEAT DEPTH: 16.0 SEAT HEIGHT: 16.5-21.0 BACK WIDTH: 18.0 BACK HEIGHT: 17.5 COM: 0.5 YD COL: 3.91 SQ FT WEIGHT: 17.5 LB	
1093	S3	SWIVEL TILT ARMED Plastic Back & Upholstered Seat	A53	571	593	616	646	681	716	746	721	771	841	<ul style="list-style-type: none"> • Upright lock • Center knob tension adjustment • 360° swivel • Pneumatic cylinder height adjustment • Arms and glides coordinate with the frame color • Stool options available for \$125 upcharge. See stool option section. 	WIDTH: 26.5 DEPTH: 26.5 HEIGHT: 34.0 SEAT WIDTH: 18.5 SEAT DEPTH: 16.0 SEAT HEIGHT: 16.5-21.0 BACK WIDTH: 18.0 BACK HEIGHT: 17.5 COM: 0.5 YD COL: 3.91 SQ FT WEIGHT: 19.5 LB	

ARM OPTIONS



Nylon Fixed Arm for 4 leg models
 A53B - Black
 A53G - Cloud Gray

CASTER OPTIONS



Large Diameter Carpet Casters



Large Diameter Hard Floor and Carpet Casters

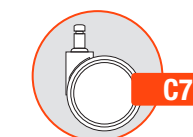

Chrome-Accented Hard Floor and Carpet Casters

BASE OPTIONS



27" Mid-Profile Nylon Base
 BA11B - Black



27" Mid-Profile Aluminum Base
 BA12B - Black
 BA12P - Polished
 BA12S - Silver
 (C7 Chrome-Accented Casters Standard with Polished Base)

STOOL OPTIONS



CY30B - 8" Stool
 (Seat Height: 22"-30")
 Use for work surfaces up to 36"



CY36B - 10" Stool
 (Seat Height: 25"-36")
 Use for work surfaces up to 42"

FRAME COLORS

BLACK BF	SILVER SF
-------------	--------------

PLASTIC COLORS

BLACK SWAN P01	WHITE WHISPER P05	FEDERAL BLUE P11	CRIMSON RED P12
LEMON YELLOW P13	DOVE GRAY P14	CLOUD GRAY P15	LAGOON BLUE P16
APPLE GREEN P17	TANGERINE ORANGE P18	LATTE P19	AZURE BLUE P20

(BACK AND SEAT)

VOX

contemporary stacking

GSA SIN # 33721 PENDING

- Stacking side, guest, task and stool
- Flexback movement
- All plastic, upholstered seat or upholstered back and seat
- Pull handle for easy mobility
- Warranted to 300 lbs.



CREATING VOX MODEL NUMBER

MODEL NUMBER CONTROL FRAME COLOR UPHOLSTERY PLASTIC COLOR BASE CASTERS PACKAGING

1 0 9 - - - F - U S - P - - - - C - - -

PACKAGING NOTES

CODE	DESCRIPTION	LIST UPCHARGE
AB	ASSEMBLED IN BAG	\$0
BAC	BACK ASSEMBLED IN CARTON	\$0

Vox stools ship 1 per carton

UPHOLSTERED SEAT - US - TASK

MODEL	CONTROL	DESCRIPTION	ARM	FABRIC/LEATHER											FEATURES	DIMENSIONS	ARM OPTIONS	CASTER OPTIONS	BASE OPTIONS	STOOL OPTIONS	FRAME COLORS	PLASTIC COLORS															
				A	B/COM	C	D	E	F	G	L3/COL	L4	L5																								
1092	R2	ROCKING TILT ARMLESS Plastic Back & Upholstered Seat	A00	571	593	616	646	681	716	746	721	771	841	<ul style="list-style-type: none"> • Rock left, right, front and back • 360° swivel • Pneumatic cylinder height adjustment • Stool options available for \$125 upcharge. See stool option section. 	WIDTH: 26.5 DEPTH: 26.5 HEIGHT: 35.0 SEAT WIDTH: 18.5 SEAT DEPTH: 16.0 SEAT HEIGHT: 17.0-21.5 BACK WIDTH: 18.0 BACK HEIGHT: 17.5 COM: 0.5 YD COL: 3.91 SQ FT WEIGHT: 24.5 LB	A53B/G STD Nylon Fixed Arm for 4 leg models A53B - Black A53G - Cloud Gray	C6 STD Large Diameter Carpet Casters	C6S \$35 Large Diameter Hard Floor and Carpet Casters	C7 \$35 Chrome-Accented Hard Floor and Carpet Casters	BA11B STD 27" Mid-Profile Nylon Base BA11B - Black	BA12B/P/S \$110 27" Mid-Profile Aluminum Base BA12B - Black BA12P - Polished BA12S - Silver (C7 Chrome-Accented Casters Standard with Polished Base)	CY30B \$125 CY30B - 8" Stool (Seat Height: 22"-30") Use for work surfaces up to 36"	CY36B \$125 CY36B - 10" Stool (Seat Height: 25"-36") Use for work surfaces up to 42"	BLACK BF SILVER SF	<table border="1"> <tr> <td>BLACK SWAN P01</td> <td>WHITE WHISPER P05</td> <td>FEDERAL BLUE P11</td> <td>CRIMSON RED P12</td> </tr> <tr> <td>LEMON YELLOW P13</td> <td>DOVE GRAY P14</td> <td>CLOUD GRAY P15</td> <td>LAGOON BLUE P16</td> </tr> <tr> <td>APPLE GREEN P17</td> <td>TANGERINE ORANGE P18</td> <td>LATTE P19</td> <td>AZURE BLUE P20</td> </tr> </table>	BLACK SWAN P01	WHITE WHISPER P05	FEDERAL BLUE P11	CRIMSON RED P12	LEMON YELLOW P13	DOVE GRAY P14	CLOUD GRAY P15	LAGOON BLUE P16	APPLE GREEN P17	TANGERINE ORANGE P18	LATTE P19	AZURE BLUE P20
BLACK SWAN P01	WHITE WHISPER P05	FEDERAL BLUE P11	CRIMSON RED P12																																		
LEMON YELLOW P13	DOVE GRAY P14	CLOUD GRAY P15	LAGOON BLUE P16																																		
APPLE GREEN P17	TANGERINE ORANGE P18	LATTE P19	AZURE BLUE P20																																		
1093	R2	ROCKING TILT ARMED Plastic Back & Upholstered Seat	A53	626	648	671	701	736	771	801	776	826	896	<ul style="list-style-type: none"> • Rock left, right, front and back • 360° swivel • Pneumatic cylinder height adjustment • Arms coordinate with the frame color • Stool options available for \$125 upcharge. See stool option section. 	WIDTH: 26.5 DEPTH: 26.5 HEIGHT: 35.0 SEAT WIDTH: 18.5 SEAT DEPTH: 16.0 SEAT HEIGHT: 17.0-21.5 BACK WIDTH: 18.0 BACK HEIGHT: 17.5 COM: 0.5 YD COL: 3.91 SQ FT WEIGHT: 26.5 LB																						

VOX

contemporary stacking

GSA SIN # 33721 PENDING

- Stacking side, guest, task and stool
- Flexback movement
- All plastic, upholstered seat or upholstered back and seat
- Pull handle for easy mobility
- Warranted to 300 lbs.



CREATING VOX MODEL NUMBER

MODEL NUMBER CONTROL FRAME COLOR UPHOLSTERY PLASTIC COLOR BASE CASTERS PACKAGING

1 0 9 - - F - U P - - - - - C - - - - -

PACKAGING NOTES

CODE	DESCRIPTION	LIST UPCHARGE
AB	ASSEMBLED IN BAG	\$0
BAC	BACK ASSEMBLED IN CARTON	\$0

Vox stools ship 1 per carton

FULLY UPHOLSTERED - UP - TASK

MODEL	CONTROL	DESCRIPTION	ARM	FABRIC/LEATHER	FEATURES	DIMENSIONS	ARM OPTIONS																				
1092	B1	BASIC TASK ARMLESS Upholstered Back & Seat	A00	<table border="1"> <thead> <tr> <th>A</th> <th>B/COM</th> <th>C</th> <th>D</th> <th>E</th> <th>F</th> <th>G</th> <th>L3/COL</th> <th>L4</th> <th>L5</th> </tr> </thead> <tbody> <tr> <td>535</td> <td>565</td> <td>585</td> <td>620</td> <td>650</td> <td>685</td> <td>720</td> <td>695</td> <td>745</td> <td>815</td> </tr> </tbody> </table>	A	B/COM	C	D	E	F	G	L3/COL	L4	L5	535	565	585	620	650	685	720	695	745	815	<ul style="list-style-type: none"> • 360° swivel • Pneumatic cylinder height adjustment • Stool options available for \$125 upcharge. See stool option section. 	<p>WIDTH: 26.5</p> <p>DEPTH: 26.5</p> <p>HEIGHT: 33.5</p> <p>SEAT WIDTH: 18.5</p> <p>SEAT DEPTH: 16.0</p> <p>SEAT HEIGHT: 16.0-20.5</p> <p>BACK WIDTH: 18.0</p> <p>BACK HEIGHT: 17.5</p> <p>COM: 1.0 YD</p> <p>WEIGHT: 28.0 LB</p>	<p>A53B/G STD</p> <p>Nylon Fixed Arm for 4 leg models A53B - Black A53G - Cloud Gray</p>
A	B/COM		C	D	E	F	G	L3/COL	L4	L5																	
535	565	585	620	650	685	720	695	745	815																		
1093	B1	A53	<table border="1"> <thead> <tr> <th>A</th> <th>B/COM</th> <th>C</th> <th>D</th> <th>E</th> <th>F</th> <th>G</th> <th>L3/COL</th> <th>L4</th> <th>L5</th> </tr> </thead> <tbody> <tr> <td>590</td> <td>620</td> <td>640</td> <td>675</td> <td>705</td> <td>740</td> <td>775</td> <td>750</td> <td>800</td> <td>870</td> </tr> </tbody> </table>	A	B/COM	C	D	E	F	G	L3/COL	L4	L5	590	620	640	675	705	740	775	750	800	870	<ul style="list-style-type: none"> • 360° swivel • Pneumatic cylinder height adjustment • Arms coordinate with the frame color • Stool options available for \$125 upcharge. See stool option section. 	<p>WIDTH: 26.5</p> <p>DEPTH: 26.5</p> <p>HEIGHT: 33.5</p> <p>SEAT WIDTH: 18.5</p> <p>SEAT DEPTH: 16.0</p> <p>SEAT HEIGHT: 16.0-20.5</p> <p>BACK WIDTH: 18.0</p> <p>BACK HEIGHT: 17.5</p> <p>COM: 1.0 YD</p> <p>WEIGHT: 30.0 LB</p>	<p>C6 STD</p> <p>Large Diameter Carpet Casters</p> <p>C6S \$35</p> <p>Large Diameter Hard Floor and Carpet Casters</p> <p>C7 \$35</p> <p>Chrome-Accented Hard Floor and Carpet Casters</p>	
A	B/COM	C	D	E	F	G	L3/COL	L4	L5																		
590	620	640	675	705	740	775	750	800	870																		
1092	S3	SWIVEL TILT ARMLESS Upholstered Back & Seat	A00	<table border="1"> <thead> <tr> <th>A</th> <th>B/COM</th> <th>C</th> <th>D</th> <th>E</th> <th>F</th> <th>G</th> <th>L3/COL</th> <th>L4</th> <th>L5</th> </tr> </thead> <tbody> <tr> <td>570</td> <td>600</td> <td>620</td> <td>655</td> <td>685</td> <td>720</td> <td>755</td> <td>730</td> <td>780</td> <td>850</td> </tr> </tbody> </table>	A	B/COM	C	D	E	F	G	L3/COL	L4	L5	570	600	620	655	685	720	755	730	780	850	<ul style="list-style-type: none"> • Upright lock • Center knob tension adjustment • 360° swivel • Pneumatic cylinder height adjustment • Stool options available for \$125 upcharge. See stool option section. 	<p>WIDTH: 26.5</p> <p>DEPTH: 26.5</p> <p>HEIGHT: 34.0</p> <p>SEAT WIDTH: 18.5</p> <p>SEAT DEPTH: 16.0</p> <p>SEAT HEIGHT: 16.5-21.0</p> <p>BACK WIDTH: 18.0</p> <p>BACK HEIGHT: 17.5</p> <p>COM: 1.0 YD</p> <p>WEIGHT: 17.5 LB</p>	<p>BA11B STD</p> <p>27" Mid-Profile Nylon Base BA11B - Black</p> <p>BA12B/P/S \$110</p> <p>27" Mid-Profile Aluminum Base BA12B - Black BA12P - Polished BA12S - Silver (C7 Chrome-Accented Casters Standard with Polished Base)</p>
A	B/COM		C	D	E	F	G	L3/COL	L4	L5																	
570	600	620	655	685	720	755	730	780	850																		
1093	S3	A53	<table border="1"> <thead> <tr> <th>A</th> <th>B/COM</th> <th>C</th> <th>D</th> <th>E</th> <th>F</th> <th>G</th> <th>L3/COL</th> <th>L4</th> <th>L5</th> </tr> </thead> <tbody> <tr> <td>625</td> <td>655</td> <td>675</td> <td>710</td> <td>740</td> <td>775</td> <td>810</td> <td>785</td> <td>835</td> <td>905</td> </tr> </tbody> </table>	A	B/COM	C	D	E	F	G	L3/COL	L4	L5	625	655	675	710	740	775	810	785	835	905	<ul style="list-style-type: none"> • Upright lock • Center knob tension adjustment • 360° swivel • Pneumatic cylinder height adjustment • Arms and glides coordinate with the frame color • Stool options available for \$125 upcharge. See stool option section. 	<p>WIDTH: 26.5</p> <p>DEPTH: 26.5</p> <p>HEIGHT: 34.0</p> <p>SEAT WIDTH: 18.5</p> <p>SEAT DEPTH: 16.0</p> <p>SEAT HEIGHT: 16.5-21.0</p> <p>BACK WIDTH: 18.0</p> <p>BACK HEIGHT: 17.5</p> <p>COM: 1.0 YD</p> <p>WEIGHT: 19.5 LB</p>	<p>CY30B \$125</p> <p>CY30B - 8" Stool (Seat Height: 22"-30") Use for work surfaces up to 36"</p> <p>CY36B \$125</p> <p>CY36B - 10" Stool (Seat Height: 25"-36") Use for work surfaces up to 42"</p>	
A	B/COM	C	D	E	F	G	L3/COL	L4	L5																		
625	655	675	710	740	775	810	785	835	905																		

FRAME COLORS

BLACK BF	SILVER SF
-------------	--------------

PLASTIC COLORS

BLACK SWAN P01	WHITE WHISPER P05	FEDERAL BLUE P11	CRIMSON RED P12
LEMON YELLOW P13	DOVE GRAY P14	CLOUD GRAY P15	LAGOON BLUE P16
APPLE GREEN P17	TANGERINE ORANGE P18	LATTE P19	AZURE BLUE P20

(BACK AND SEAT)

257

VOX

contemporary stacking

GSA SIN # 33721 PENDING

- Stacking side, guest, task and stool
- Flexback movement
- All plastic, upholstered seat or upholstered back and seat
- Pull handle for easy mobility
- Warranted to 300 lbs.



CREATING VOX MODEL NUMBER

MODEL NUMBER CONTROL FRAME COLOR UPHOLSTERY PLASTIC COLOR BASE CASTERS PACKAGING

1 0 9 - - - F - U P - - - - - C - - -

PACKAGING NOTES

CODE	DESCRIPTION	LIST UPCHARGE
AB	ASSEMBLED IN BAG	\$0
BAC	BACK ASSEMBLED IN CARTON	\$0

Vox stools ship 1 per carton

FULLY UPHOLSTERED - UP - TASK

MODEL	CONTROL	DESCRIPTION	ARM	FABRIC/LEATHER											FEATURES	DIMENSIONS	ARM OPTIONS	CASTER OPTIONS	BASE OPTIONS	STOOL OPTIONS	FRAME COLORS	PLASTIC COLORS			
				A	B/COM	C	D	E	F	G	L3/COL	L4	L5												
1092	R2	ROCKING TILT ARMLESS Upholstered Back & Seat	A00	625	655	675	710	740	775	810	785	835	905	<ul style="list-style-type: none"> • Rock left, right, front and back • 360° swivel • Pneumatic cylinder height adjustment • Stool options available for \$125 upcharge. See stool option section. 	WIDTH: 26.5 DEPTH: 26.5 HEIGHT: 35.0 SEAT WIDTH: 18.5 SEAT DEPTH: 16.0 SEAT HEIGHT: 17.0-21.5 BACK WIDTH: 18.0 BACK HEIGHT: 17.5 COM: 1.0 YD WEIGHT: 24.5 LB	A53B/G STD Nylon Fixed Arm for 4 leg models A53B - Black A53G - Cloud Gray	C6 STD Large Diameter Carpet Casters	C6S \$35 Large Diameter Hard Floor and Carpet Casters	C7 \$35 Chrome-Accented Hard Floor and Carpet Casters	BA11B STD 27" Mid-Profile Nylon Base BA11B - Black	BA12B/P/S \$110 27" Mid-Profile Aluminum Base BA12B - Black BA12P - Polished BA12S - Silver (C7 Chrome-Accented Casters Standard with Polished Base)	CY30B \$125 CY30B - 8" Stool (Seat Height: 22"-30") Use for work surfaces up to 36"	CY36B \$125 CY36B - 10" Stool (Seat Height: 25"-36") Use for work surfaces up to 42"	BLACK BF SILVER SF	BLACK SWAN P01 WHITE WHISPER P05 FEDERAL BLUE P11 CRIMSON RED P12 LEMON YELLOW P13 DOVE GRAY P14 CLOUD GRAY P15 LAGOON BLUE P16 APPLE GREEN P17 TANGERINE ORANGE P18 LATTE P19 AZURE BLUE P20
1093	R2	ROCKING TILT ARMED Upholstered Back & Seat	A53	680	710	730	765	795	830	865	840	890	960	<ul style="list-style-type: none"> • Rock left, right, front and back • 360° swivel • Pneumatic cylinder height adjustment • Arms coordinate with the frame color • Stool options available for \$125 upcharge. See stool option section. 	WIDTH: 26.5 DEPTH: 26.5 HEIGHT: 35.0 SEAT WIDTH: 18.5 SEAT DEPTH: 16.0 SEAT HEIGHT: 17.0-21.5 BACK WIDTH: 18.0 BACK HEIGHT: 17.5 COM: 1.0 YD WEIGHT: 26.5 LB										

(BACK AND SEAT)

259

zoom

rapid setup for a crew or a crowd

GSA SIN # 33721

- Multipurpose seating, including nesting, task and task stool models
- Mesh back with plastic or upholstered seat
- Warranted to 300 lbs.



CREATING ZOOM MODEL NUMBER

MODEL NUMBER	CONTROL	ARM	UPHOLSTERY	PLASTIC COLOR	MESH COLOR	BASE	CASTERS	PACKAGING
112	B2	A	AP	P	M	BA	C	

PACKAGING NOTES

CODE	DESCRIPTION	LIST UPCHARGE
AB	ASSEMBLED IN BAG	\$0
AC	ASSEMBLED IN CARTON	\$0

TASK - MESH BACK & PLASTIC SEAT - AP

MODEL	CONTROL	DESCRIPTION	ARM	PLASTIC	FEATURES	DIMENSIONS																																	
1125	B2	BASIC TASK - AP Mesh back with plastic seat	A00 A51	P 637 702	<ul style="list-style-type: none"> • 360° swivel • Pneumatic cylinder height adjustment 	<table border="1"> <thead> <tr> <th></th> <th>ARMLESS</th> <th>W/ ARMS</th> </tr> </thead> <tbody> <tr> <td>WIDTH:</td> <td>26.5</td> <td>26.5</td> </tr> <tr> <td>DEPTH:</td> <td>26.5</td> <td>26.5</td> </tr> <tr> <td>HEIGHT:</td> <td>35.0</td> <td>35.0</td> </tr> <tr> <td>SEAT WIDTH:</td> <td>17.5</td> <td>17.5</td> </tr> <tr> <td>SEAT DEPTH:</td> <td>16.5</td> <td>16.5</td> </tr> <tr> <td>SEAT HEIGHT:</td> <td>17.0-22.0</td> <td>17.0-22.0</td> </tr> <tr> <td>BACK WIDTH:</td> <td>18.0</td> <td>18.0</td> </tr> <tr> <td>BACK HEIGHT:</td> <td>19.0</td> <td>19.0</td> </tr> <tr> <td>COM:</td> <td>N/A</td> <td>N/A</td> </tr> <tr> <td>WEIGHT:</td> <td>20.0 LB</td> <td>24.0 LB</td> </tr> </tbody> </table>		ARMLESS	W/ ARMS	WIDTH:	26.5	26.5	DEPTH:	26.5	26.5	HEIGHT:	35.0	35.0	SEAT WIDTH:	17.5	17.5	SEAT DEPTH:	16.5	16.5	SEAT HEIGHT:	17.0-22.0	17.0-22.0	BACK WIDTH:	18.0	18.0	BACK HEIGHT:	19.0	19.0	COM:	N/A	N/A	WEIGHT:	20.0 LB	24.0 LB
	ARMLESS	W/ ARMS																																					
WIDTH:	26.5	26.5																																					
DEPTH:	26.5	26.5																																					
HEIGHT:	35.0	35.0																																					
SEAT WIDTH:	17.5	17.5																																					
SEAT DEPTH:	16.5	16.5																																					
SEAT HEIGHT:	17.0-22.0	17.0-22.0																																					
BACK WIDTH:	18.0	18.0																																					
BACK HEIGHT:	19.0	19.0																																					
COM:	N/A	N/A																																					
WEIGHT:	20.0 LB	24.0 LB																																					
1126	B2	10" STOOL BASIC TASK - AP Use for work surfaces up to 42" high	A00 A51	P 762 827	<ul style="list-style-type: none"> • Height-adjustable 20" diameter foot ring • 360° swivel • Pneumatic cylinder height adjustment 	<table border="1"> <tbody> <tr> <td>WIDTH:</td> <td>26.5</td> <td>26.5</td> </tr> <tr> <td>DEPTH:</td> <td>26.5</td> <td>26.5</td> </tr> <tr> <td>HEIGHT:</td> <td>35.0</td> <td>35.0</td> </tr> <tr> <td>SEAT WIDTH:</td> <td>17.5</td> <td>17.5</td> </tr> <tr> <td>SEAT DEPTH:</td> <td>16.5</td> <td>16.5</td> </tr> <tr> <td>SEAT HEIGHT:</td> <td>26.0-36.0</td> <td>26.0-36.0</td> </tr> <tr> <td>BACK WIDTH:</td> <td>18.0</td> <td>18.0</td> </tr> <tr> <td>BACK HEIGHT:</td> <td>19.0</td> <td>19.0</td> </tr> <tr> <td>COM:</td> <td>N/A</td> <td>N/A</td> </tr> <tr> <td>WEIGHT:</td> <td>27.0 LB</td> <td>31.0 LB</td> </tr> </tbody> </table>	WIDTH:	26.5	26.5	DEPTH:	26.5	26.5	HEIGHT:	35.0	35.0	SEAT WIDTH:	17.5	17.5	SEAT DEPTH:	16.5	16.5	SEAT HEIGHT:	26.0-36.0	26.0-36.0	BACK WIDTH:	18.0	18.0	BACK HEIGHT:	19.0	19.0	COM:	N/A	N/A	WEIGHT:	27.0 LB	31.0 LB			
WIDTH:	26.5	26.5																																					
DEPTH:	26.5	26.5																																					
HEIGHT:	35.0	35.0																																					
SEAT WIDTH:	17.5	17.5																																					
SEAT DEPTH:	16.5	16.5																																					
SEAT HEIGHT:	26.0-36.0	26.0-36.0																																					
BACK WIDTH:	18.0	18.0																																					
BACK HEIGHT:	19.0	19.0																																					
COM:	N/A	N/A																																					
WEIGHT:	27.0 LB	31.0 LB																																					
1128	B2	8" STOOL BASIC TASK - AP Use for work surfaces up to 36" high	A00 A51	P 762 827	<ul style="list-style-type: none"> • Height-adjustable 20" diameter foot ring • 360° swivel • Pneumatic cylinder height adjustment 	<table border="1"> <tbody> <tr> <td>WIDTH:</td> <td>26.5</td> <td>26.5</td> </tr> <tr> <td>DEPTH:</td> <td>26.5</td> <td>26.5</td> </tr> <tr> <td>HEIGHT:</td> <td>35.0</td> <td>35.0</td> </tr> <tr> <td>SEAT WIDTH:</td> <td>17.5</td> <td>17.5</td> </tr> <tr> <td>SEAT DEPTH:</td> <td>16.5</td> <td>16.5</td> </tr> <tr> <td>SEAT HEIGHT:</td> <td>21.5-29.5</td> <td>21.5-29.5</td> </tr> <tr> <td>BACK WIDTH:</td> <td>18.0</td> <td>18.0</td> </tr> <tr> <td>BACK HEIGHT:</td> <td>19.0</td> <td>19.0</td> </tr> <tr> <td>COM:</td> <td>N/A</td> <td>N/A</td> </tr> <tr> <td>WEIGHT:</td> <td>26.0 LB</td> <td>30.0 LB</td> </tr> </tbody> </table>	WIDTH:	26.5	26.5	DEPTH:	26.5	26.5	HEIGHT:	35.0	35.0	SEAT WIDTH:	17.5	17.5	SEAT DEPTH:	16.5	16.5	SEAT HEIGHT:	21.5-29.5	21.5-29.5	BACK WIDTH:	18.0	18.0	BACK HEIGHT:	19.0	19.0	COM:	N/A	N/A	WEIGHT:	26.0 LB	30.0 LB			
WIDTH:	26.5	26.5																																					
DEPTH:	26.5	26.5																																					
HEIGHT:	35.0	35.0																																					
SEAT WIDTH:	17.5	17.5																																					
SEAT DEPTH:	16.5	16.5																																					
SEAT HEIGHT:	21.5-29.5	21.5-29.5																																					
BACK WIDTH:	18.0	18.0																																					
BACK HEIGHT:	19.0	19.0																																					
COM:	N/A	N/A																																					
WEIGHT:	26.0 LB	30.0 LB																																					

ARM OPTIONS

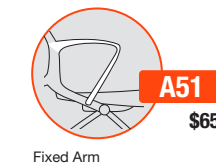

Fixed Arm

CASTER OPTIONS

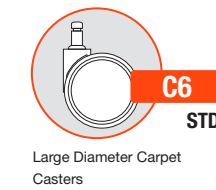

Large Diameter Carpet Casters



Large Diameter Hard Floor and Carpet Casters

BASE OPTIONS



27" Mid-Profile Nylon Base
BA11G - Gray
BA11W - White



27" Mid-Profile Aluminum Base - Polished (C7 Chrome-Accented Casters Standard with Polished Base)

FRAME COLORS



PLASTIC AND MESH COLORS



(BACK/SEAT SHELL AND ARMS)



(BACK/SEAT SHELL AND ARMS)

zoom

rapid setup for a crew or a crowd

GSA SIN # 33721

- Multipurpose seating, including nesting, task and task stool models
- Mesh back with plastic or upholstered seat
- Warranted to 300 lbs.



CREATING ZOOM MODEL NUMBER

MODEL NUMBER CONTROL ARM UPHOLSTERY GRADE PLASTIC COLOR MESH COLOR BASE CASTERS PACKAGING
1 1 2 - **B 2** - **A** - **U S** - **P** - **M** - **B A** - **C**

PACKAGING NOTES

CODE	DESCRIPTION	LIST UPCHARGE
AB	ASSEMBLED IN BAG	\$0
AC	ASSEMBLED IN CARTON	\$0

TASK - MESH BACK & UPHOLSTERED SEAT - US

MODEL	CONTROL	DESCRIPTION	ARM	FABRIC							FEATURES	DIMENSIONS		
				A	B/COM	C	D	E	F	G		ARMLESS	W/ ARMS	
1125	B2	BASIC TASK - US Mesh back with upholstered seat	A00	710	740	770	820	875	920	990	<ul style="list-style-type: none"> • 360° swivel • Pneumatic cylinder height adjustment 	WIDTH:	26.5	26.5
			A51	775	805	835	885	940	985	1,055		DEPTH:	26.5	26.5
											HEIGHT:	35.0	35.0	
											SEAT WIDTH:	17.5	17.5	
											SEAT DEPTH:	16.5	16.5	
											SEAT HEIGHT:	18.0-23.0	18.0-23.0	
											BACK WIDTH:	18.0	18.0	
											BACK HEIGHT:	19.0	19.0	
											COM:	0.9 YD	0.9 YD	
											WEIGHT:	21.0 LB	25.0 LB	
1126	B2	10" STOOL BASIC TASK - US Use for work surfaces up to 42" high	A00	835	865	895	945	1000	1045	1115	<ul style="list-style-type: none"> • Height-adjustable 20" diameter foot ring • 360° swivel • Pneumatic cylinder height adjustment 	WIDTH:	26.5	26.5
			A51	900	930	960	1010	1065	1110	1180		DEPTH:	26.5	26.5
											HEIGHT:	35.0	35.0	
											SEAT WIDTH:	17.5	17.5	
											SEAT DEPTH:	16.5	16.5	
											SEAT HEIGHT:	27.0-37.0	27.0-37.0	
											BACK WIDTH:	18.0	18.0	
											BACK HEIGHT:	19.0	19.0	
											COM:	0.9 YD	0.9 YD	
											WEIGHT:	28.0 LB	32.0 LB	
1128	B2	8" STOOL BASIC TASK - US Use for work surfaces up to 36" high	A00	835	865	895	945	1000	1045	1115	<ul style="list-style-type: none"> • Height-adjustable 20" diameter foot ring • 360° swivel • Pneumatic cylinder height adjustment 	WIDTH:	26.5	26.5
			A51	900	930	960	1010	1065	1110	1180		DEPTH:	26.5	26.5
											HEIGHT:	35.0	35.0	
											SEAT WIDTH:	17.5	17.5	
											SEAT DEPTH:	16.5	16.5	
											SEAT HEIGHT:	22.5-30.5	22.5-30.5	
											BACK WIDTH:	18.0	18.0	
											BACK HEIGHT:	19.0	19.0	
											COM:	0.9 YD	0.9 YD	
											WEIGHT:	27.0 LB	31.0 LB	

ARM OPTIONS

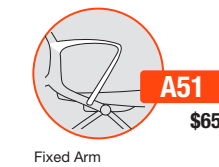

Fixed Arm

A51
\$65

CASTER OPTIONS



Large Diameter Carpet Casters

C6
STD



Large Diameter Hard Floor and Carpet Casters

C6S
\$35

BASE OPTIONS



27" Mid-Profile Nylon Base
BA11G - Gray
BA11W - White

BA11G/W
STD



27" Mid-Profile Aluminum Base - Polished (C7 Chrome-Accented Casters Standard with Polished Base)

BA12P
\$110

FRAME COLORS

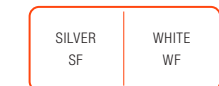

PLASTIC AND MESH COLORS



(BACK/SEAT SHELL AND ARMS)











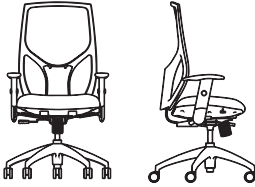

(BACK/SEAT SHELL AND ARMS)

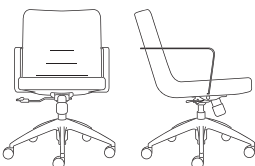
- Ships in 24 hours
- Task, conference and executive seating
- Bleach cleanable (10:1 solution) except HÅG SoFi seat fabric
- Five-year warranty
- Assembly required
- Warranted to 300 lbs.
- GREENGUARD Gold

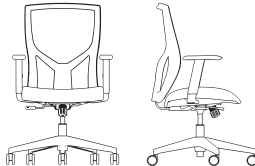
PACKAGING NOTES

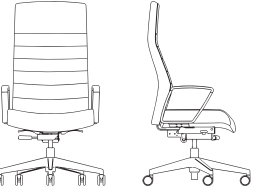
CODE	DESCRIPTION	LIST UPCHARGE
	SHIPS IN BOX ONLY	

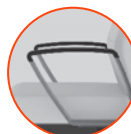
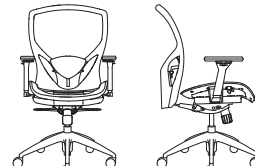
SIT IN STYLE. WORK IN COMFORT. GET THE VALUE.

MODEL	FEATURES	DIMENSIONS	ARM	TEXTILES	MODEL	FEATURES	DIMENSIONS	ARM	TEXTILES	
146 	\$785 <ul style="list-style-type: none"> • Y1 - Simple Synchro • Height adjustable arms • Bleach cleanable (10:1 solution) • Ratchet back • Warranted to 300 lbs. 	WIDTH: 24.5-26.0 DEPTH: 25.0 HEIGHT: 39.0-46.0 SEAT WIDTH: 20.0 SEAT DEPTH: 16.0-18.5 SEAT HEIGHT: 17.5-22.5 BACK WIDTH: 18.5 BACK HEIGHT: 23.0-25.5 WEIGHT: 40.5 LB	A8B  Height adjustable	BACK BLACK MESH M21 SEAT BLACK AIR GRID MESH	245 	\$1046 <ul style="list-style-type: none"> • Contemporary design with channel stitching • S3-swivel tilt • Fixed chrome arms • Aluminum base • Bleach cleanable (10:1 solution) • Warranted to 300 lbs. 	WIDTH: 21.5 DEPTH: 27.5 HEIGHT: 31.50-36.0 SEAT WIDTH: 19.0 SEAT DEPTH: 18.0 SEAT HEIGHT: 17.0-21.5 BACK WIDTH: 18.0 BACK HEIGHT: 16.5 COM: 2.0 YD COL: 19.0 SQ FT WEIGHT: 31.0 LB	A24  Fixed Chrome Wraparound Arm	BACK PAULY BLACK SEAT PAULY BLACK	
205 	\$596 <ul style="list-style-type: none"> • Contemporary design • Y1-Simple synchro • Height adjustable arms • Bleach cleanable (10:1 solution) • 3" thick molded foam seat • Warranted to 300 lbs. 	WIDTH: 25.5 DEPTH: 24.5 HEIGHT: 36.0-41.0 SEAT WIDTH: 19.5 SEAT DEPTH: 17.5 SEAT HEIGHT: 16.0-20.5 BACK WIDTH: 19.0 BACK HEIGHT: 22.5 WEIGHT: 33.5 LB	A205  Height adjustable	BACK BLACK MESH M11 SEAT BLACK AIR GRID MESH	305 	\$991 <ul style="list-style-type: none"> • Sleek contemporary design • Y2 - Heavy Duty Synchro Tilt • Aluminum fixed arms with black arm pads • Bleach cleanable (10:1 solution) • Molded foam seat and back • Black nylon base • Warranted to 300 lbs. 	WIDTH: 27.5 DEPTH: 24.5 HEIGHT: 42.0-47.0 SEAT WIDTH: 21.5 SEAT DEPTH: 16.5 SEAT HEIGHT: 17.0-21.5 BACK WIDTH: 20.0 BACK HEIGHT: 27.0 WEIGHT: 50.0 LB	A52  Fixed Arm	BACK BLACK VINYL SEAT BLACK VINYL	
216 	\$812 <ul style="list-style-type: none"> • Y1-Simple synchro • Ratchet back w/ adjustable lumbar • 8-way adjustable arms • Bleach cleanable (10:1 solution) • 3" thick molded foam • Warranted to 300 lbs. 	WIDTH: 26.5 DEPTH: 26.5 HEIGHT: 38.5-45.5 SEAT WIDTH: 21.0 SEAT DEPTH: 20.0 SEAT HEIGHT: 17.5-22.0 BACK WIDTH: 20.5 BACK HEIGHT: 21.0-24.0 WEIGHT: 44.0 LB	A36  8-way adjustable	BACK GRAPHITE MESH M31 SEAT BLACK AIR GRID MESH	306 	\$1053 <ul style="list-style-type: none"> • Sleek contemporary design • Y2 - Heavy Duty Synchro Tilt • Aluminum fixed arms with black arm pads • Bleach cleanable (10:1 solution) • Molded foam seat and back • Polished aluminum base with chrome-accented casters • Warranted to 300 lbs. 	WIDTH: 27.5 DEPTH: 24.5 HEIGHT: 42.0-47.0 SEAT WIDTH: 21.5 SEAT DEPTH: 16.5 SEAT HEIGHT: 17.0-21.5 BACK WIDTH: 20.0 BACK HEIGHT: 27.0 WEIGHT: 50.0 LB	A52  Fixed Arm	BACK WHITE VINYL SEAT WHITE VINYL	
217 	\$936 <ul style="list-style-type: none"> • Y3-Full synchro • Ratchet back w/ adjustable lumbar • Bleach cleanable (10:1 solution) • 8-way adjustable arms • Polished aluminum base • Warranted to 300 lbs. 	WIDTH: 26.5 DEPTH: 26.5 HEIGHT: 39.0-46.0 SEAT WIDTH: 19.5 SEAT DEPTH: 18.0 SEAT HEIGHT: 17.5-22.0 BACK WIDTH: 20.5 BACK HEIGHT: 22.5-25.5 WEIGHT: 46.0 LB	A36  8-way adjustable	BACK GRAPHITE MESH M31 SEAT GRAPHITE MESH M31						







- Ships in 24 hours
- Task, conference and executive seating
- Bleach cleanable (10:1 solution) except HÅG SoFi seat fabric
- Five-year warranty
- Assembly required
- Warranted to 300 lbs.
- GREENGUARD Gold

PACKAGING NOTES

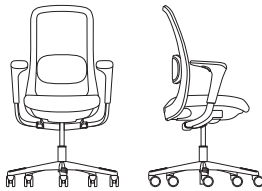
CODE	DESCRIPTION	LIST UPCHARGE
	SHIPS IN BOX ONLY	

SIT IN STYLE. WORK IN COMFORT. GET THE VALUE.

MODEL	FEATURES	DIMENSIONS	ARM	TEXTILES	MODEL	FEATURES	DIMENSIONS	ARM	TEXTILES											
<p>750</p>  <p>\$1876</p>	<ul style="list-style-type: none"> • HÅG in Balance mechanism (balanced, flowing tilt function) • Seat depth adjustment • Adjustable lumbar • Fully adjustable slideback arms • Black aluminum base • Limited lifetime warranty-same as 9to5 chairs • LEVEL 2 and GREENGUARD GOLD • Warranted to 300 lbs. 	<p>WIDTH: 29.0 DEPTH: 29.0 HEIGHT: 50.0 SEAT WIDTH: 18.0 SEAT DEPTH: 18.5 SEAT HEIGHT: 15.5-21.5 BACK WIDTH: 18.0 BACK HEIGHT: 28.5 WEIGHT: 38.0 LB</p>	<p>A56</p>  <p>Height/Width adjustment arms slide back to move closer to desk or table</p>	<p>BACK</p> <p>BLACK MESH</p> <p>SEAT</p> <p>GABRIEL SELECT-BLACK</p>																
<p>751</p>  <p>\$1876</p>	<ul style="list-style-type: none"> • HÅG in Balance mechanism (balanced, flowing tilt function) • Seat depth adjustment • Adjustable lumbar • Fully adjustable slideback arms • Silver aluminum base • Limited lifetime warranty-same as 9to5 chairs • LEVEL 2 and GREENGUARD GOLD • Warranted to 300 lbs. 	<p>WIDTH: 29.0 DEPTH: 29.0 HEIGHT: 50.0 SEAT WIDTH: 18.0 SEAT DEPTH: 18.5 SEAT HEIGHT: 15.5-21.5 BACK WIDTH: 18.0 BACK HEIGHT: 28.5 WEIGHT: 38.0 LB</p>	<p>A56</p>  <p>Height/Width adjustment arms slide back to move closer to desk or table</p>	<p>BACK</p> <p>GRAY MESH</p> <p>SEAT</p> <p>GABRIEL SELECT-DARK GRAY</p>																

TASKING ARM OPTIONS

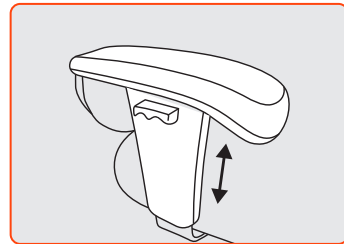

A4

\$100

HEIGHT-ADJUSTABLE ARM

Adjust the height by 3" with the underpad lever. The anti-skid arm pad features a diamond pattern.

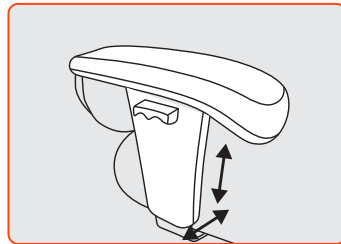

A5

\$115

HEIGHT- AND WIDTH-ADJUSTABLE ARM

Adjust the height by 3" with the underpad lever, and adjust the width by 4" with the underseat knob. The anti-skid arm pad features a diamond pattern.

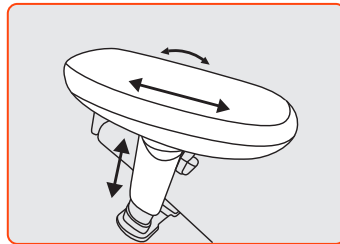

A6

\$160

HEIGHT-ADJUSTABLE ARM WITH PIVOTING AND SLIDING PAD

Adjust the height with the trigger. The polyurethane arm pad slides forward, backward, and pivots.

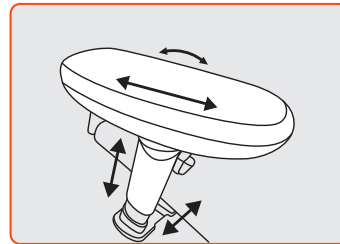

A7

\$175

HEIGHT- AND WIDTH-ADJUSTABLE ARM WITH PIVOTING AND SLIDING PAD

Adjust the height with the trigger, and adjust the width by 4" with the underseat knob. The polyurethane arm pad slides forward, backward, and pivots.

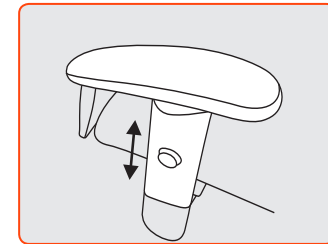

A8

\$105

HEIGHT-ADJUSTABLE ARM

Adjust the height by 3.5" with the push button. Available in Black and Silver.

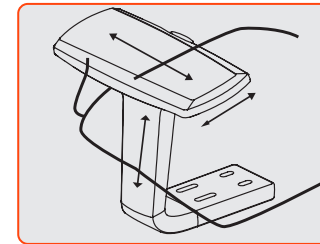

A23

\$95

HEIGHT-ADJUSTABLE ARM WITH SLIDING PAD

Adjust the height with the trigger. The arm pad slides forward, backward, and side to side. Available in Black, Graphite Gray, and White.

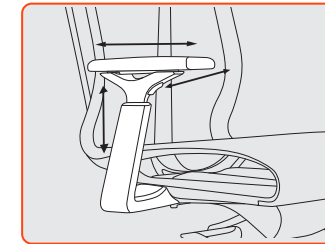

A35

\$125

HEIGHT-ADJUSTABLE ARM WITH SLIDING PAD

Adjust the height with the trigger. The arm pad slides forward, backward, and side to side. Available in Black, Graphite Gray, and White. Exclusively on Cydia.

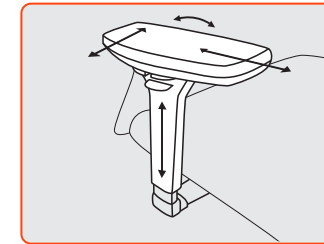

A36

\$125

HEIGHT-ADJUSTABLE ARM WITH PIVOTING AND SLIDING PAD

Adjust the height with the underpad lever. The soft-touch arm pad slides forward, backward, side to side, and pivots 23 degrees.



A37

\$140

MULTI-ADJUST. PIVOT/SWIVEL

Adjust the height with the underpad lever, and adjust the width with the underseat knob. The soft-touch arm pad slides forward, backward, side to side, and pivots 23 degrees.

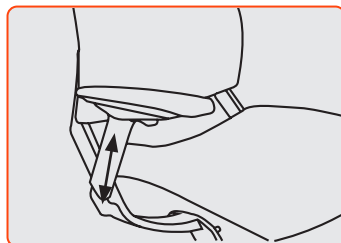

A38

\$95

HEIGHT-ADJUSTABLE ARM

Adjust the height with the trigger. Exclusively on Cosmo.



A45

\$90

HEIGHT- AND WIDTH-ADJUSTABLE ARM

Adjust the height with the trigger, and adjust the width using the underseat lever. Available in Black and Dove Gray. Exclusively on Luna.

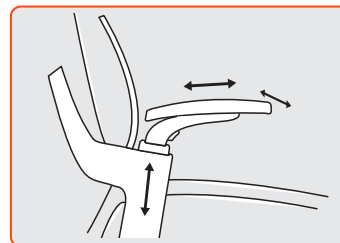

A48

\$150

HEIGHT-ADJUSTABLE ARM WITH SLIDING PAD

Adjust the height with the push button. The arm pad slides forward, backward, and side to side. Exclusively on Sol.

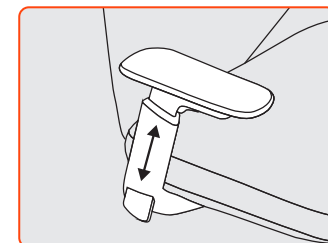

A57

\$90

HEIGHT ADJUSTABLE ARM

Adjust the height by 4" with the trigger. Available in Black, Dove Gray and White.

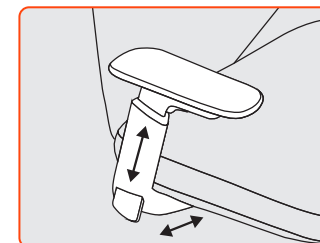

A58

\$125

HEIGHT AND-WIDTH-ADJUSTABLE ARM

Adjust the height by 4" with the trigger and adjust the width using the underseat lever. Available in Black, Dove Gray and White.

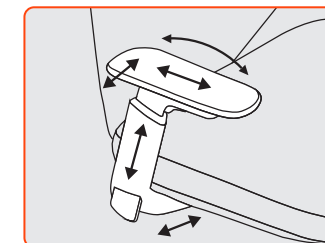

A59

\$160

HEIGHT AND-WIDTH-ADJUSTABLE ARM WITH PIVOTING AND SLIDING PAD

Adjust the height by 4" with the trigger and adjust the width using the underseat lever. The pad slides forward, backward, side to side and pivots 25 degrees. Available in Black, Dove Gray and White.

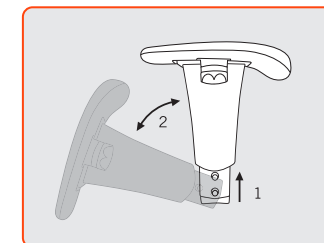

A90

\$235

HEIGHT/WIDTH ADJUSTABLE BREAKAWAY ARM

Adjust the height by 2.5" with the underpad lever and adjust the width using the underseat knob.

PARTS AND ACCESSORIES DISCOUNT

INDIVIDUAL PARTS & ACCESSORIES WHEN PURCHASED SEPARATE FROM A CHAIR RECEIVE AN EVEN 50% DISCOUNT. THE 50% ACCESSORY DISCOUNT PROVIDES FOR EXTRA LABOR, PACKAGING MATERIAL AND SHIPPING CHARGES ASSOCIATED WITH SHIPPING A COMPONENT BY ITSELF.

arm guide

FIXED ARM OPTIONS

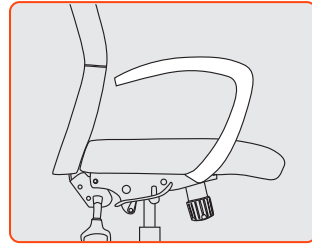

A10 \$110

CANTILEVER ARM
Soft-touch cantilever arm. Available in Black.

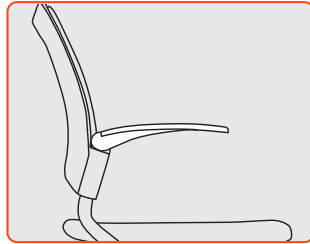

A12 \$60

FIXED ARM
Available in Black. Exclusively on Bella.

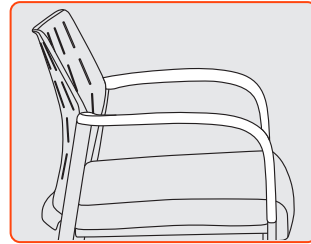

A15 \$70

SOFT-TOUCH ARM
Available in Black and Gray. Exclusively on Link.

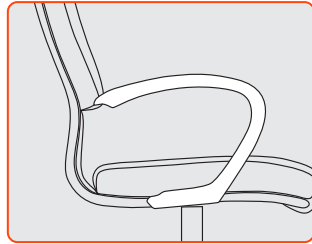

A16 \$125

'C' ARM
Soft-touch C-shaped arm. Available in Black.

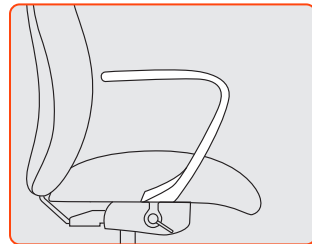

A27 \$235

ALUMINUM CANTILEVER ARM
C-shaped polished aluminum arm with a matching upholstered arm pad. Exclusively on Acclaim.

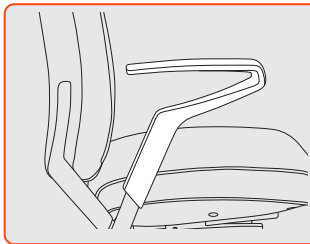

A31 \$90

SOFT-TOUCH FIXED CANTILEVER ARM
Available in Black. Exclusively on Cosmo.

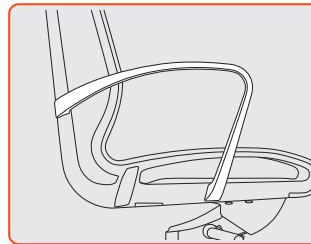

A34 \$95

NYLON LOOP ARM
Available in Black, Graphite Gray and White. Exclusively on Cydia.



A43 \$70

NYLON FIXED ARM
Available in Black and Dove Gray.

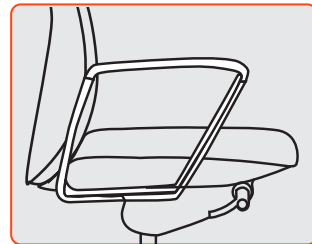

A52 \$95

POLISHED ALUMINUM LOOP ARM
Exclusively on @305 and @306.



A53 \$55

NYLON FIXED ARM
Available in Black and Cloud Gray. Exclusively on Dash and Vox 4 leg guest and task models.



A54 \$55

NYLON FIXED ARM
Available in Black and Cloud Gray. Exclusively on Dash and Vox sled guest models.

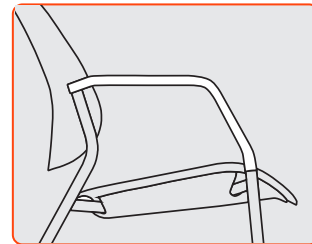

A55 \$60

SOFT TOUCH POLYURETHANE ARM
Available in Black and Gray. Exclusively used on Cavo guest, stool and bariatric models.

PARTS AND ACCESSORIES DISCOUNT

INDIVIDUAL PARTS & ACCESSORIES WHEN PURCHASED SEPARATE FROM A CHAIR RECEIVE A 50% DISCOUNT, WHICH INCLUDES SHIPPING.

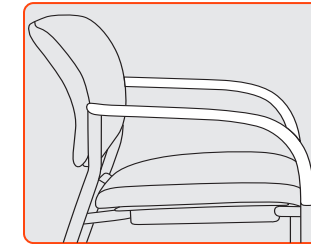

A18 \$65

SOFT TOUCH POLYURETHANE ARM
Available in Black and Gray. Exclusively on Shuttle.

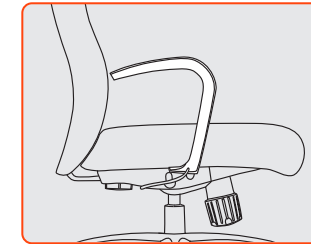

A19 \$235

CHROME CANTILEVER ARM
C-shaped polished aluminum arm with a black urethane pad.

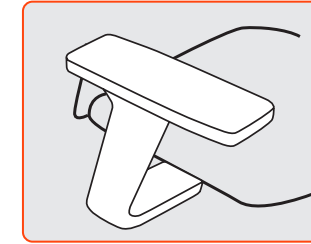

A22 \$70

FIXED ARM WITH SOFT PAD
Available in Black. Exclusively on Core.

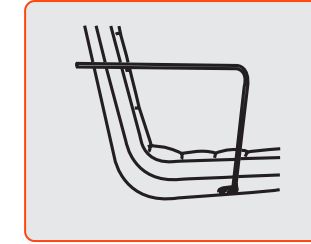

A24 \$135

FIXED WRAPAROUND ARM
Flat arms with a Black or Chrome finish that wrap around the chair back. Exclusively on Diddy.

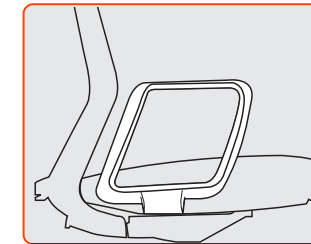

A46 \$75

NYLON LOOP ARM
Available in Black, Graphite Gray and White. Exclusively on Neo and Neo Lite.

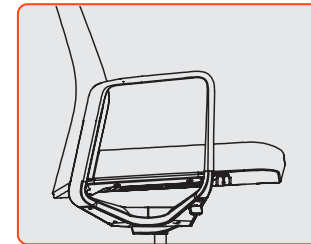

A47 STD

FIXED ALUMINUM LOOP ARM WITH SOFT URETHANE PAD
Sculpted aluminum arm that features a soft-touch urethane arm pad. Available in Silver and Polished Aluminum. Exclusively on Mila.

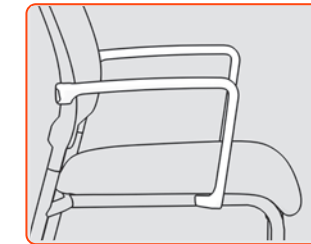

A49 \$60

NYLON FIXED ARM
Available in Black, Dove Gray and Graphite Gray. Exclusively on Clary and Luna side.

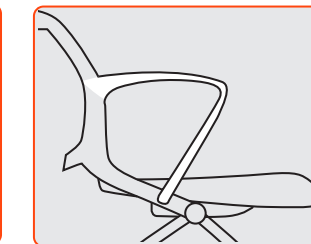

A51 \$65

FIXED ARM
Available in Graphite Gray and White. Exclusively on Zoom.

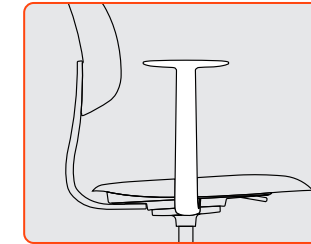

A60 \$75



ALUMINUM FIXED ARMS
Available in black, moss, tumbled, white, silver, blush rose, and polished. Exclusively on Tion.

caster guide

PARTS AND ACCESSORIES DISCOUNT

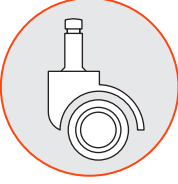
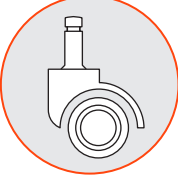
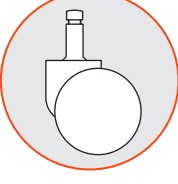
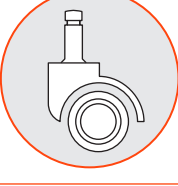
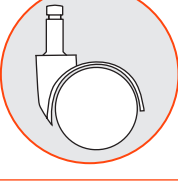
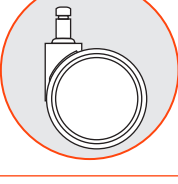
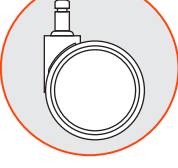
INDIVIDUAL PARTS & ACCESSORIES WHEN PURCHASED SEPARATE FROM A CHAIR RECEIVE A 50% DISCOUNT, WHICH INCLUDES SHIPPING.

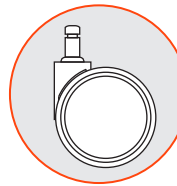
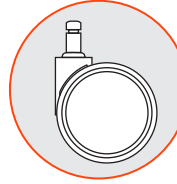
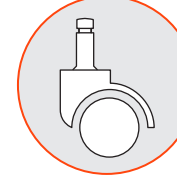
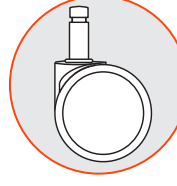
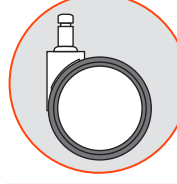
	C1 CARPET CASTERS	\$25	HOODED TWIN WHEEL CASTER WHEEL: 50 MM BARREL: 42 MM LOAD RATING: 110 LBS*	Best for use on carpeted surfaces. Hard nylon wheels are recommended for use on low-to-medium pile carpeting without padding. Dual wheels place more wheel surface on the carpet pile for optimum weight distribution. Wheels move in opposite directions to minimize carpet fiber twisting.
	C1S HARD FLOOR AND CARPET CASTERS	\$35	HOODED TWIN WHEEL CASTER WHEEL: 50 MM BARREL: 42 MM LOAD RATING: 110 LBS*	Designed for use on carpet, hardwood floors, tile, chair mats, linoleum and concrete surfaces in an open office/workspace environment. (Lab, healthcare, classroom, and conference room.) Wheels are made from a soft polyurethane material. Set of five used with star bases.
	C2S DECOMPRESSION HARD FLOOR AND CARPET CASTERS	\$35	HOODED TWIN WHEEL CASTER WHEEL: 50 MM BARREL: 42 MM LOAD RATING: 110 LBS*	Designed for use on carpet, hardwood floors, tile, chair mats, linoleum and concrete surfaces in an open office/workspace environment. (Lab, healthcare, classroom, and conference room.) Wheels are made from a soft polyurethane material. Set of five used with star bases. The wheels feature auto-lock; The safety brakes engage when the chair is not in use, this prevents the chair from rolling away when standing up.
	C4 HEAVY DUTY HARD WOOD FLOOR AND CARPET CASTERS	\$25	HOODLESS TWIN WHEEL CASTER WHEEL: 60 MM BARREL: 38 MM LOAD RATING: 140 LBS*	Recommended when higher weight capacity is required. Large diameter hard nylon wheels designed for use on low- to medium-pile carpeting with or without padding. Large diameter dual wheels place more wheel surface on the carpet pile for optimum weight distribution. Wheels move in opposite directions to minimize carpet fiber twisting.
	C5 CARPET CASTERS	\$30	HOODED TWIN WHEEL CASTER WHEEL: 50 MM BARREL: 27 MM LOAD RATING: 110 LBS*	Best for use on carpeted surfaces. Hard nylon wheels are recommended for use on low- to medium-pile carpeting without padding. Dual wheels place more wheel surface on the carpet pile for optimum weight distribution. Wheels move in opposite directions to minimize carpet fiber twisting. Set of four used on guest chairs.
	C5S HARD FLOOR AND CARPET CASTERS	\$30	HOODED TWIN WHEEL CASTER WHEEL: 50 MM BARREL: 13 MM LOAD RATING: 110 LBS*	Designed for use on hardwood floors, tile, chair mats, linoleum and concrete surfaces in an open office/workspace environment. (Lab, healthcare, classroom, and conference room.) Wheels are made from a soft polyurethane material. Set of four used on guest chairs.
	C6 LARGE DIAMETER CARPET CASTERS	\$30	TWIN WHEEL CASTER WHEEL: 60 MM BARREL: 25 MM LOAD RATING: 140 LBS*	Recommended for use on carpeted surfaces. Large diameter hard nylon wheels are recommended for use on low to medium pile carpeting with or without padding. 60 mm dual wheels place more wheel surface on the carpet pile for optimum weight distribution and ease of movement. Wheels move in opposite directions to minimize carpet fiber twisting.
	C6S LARGE DIAMETER HARD FLOOR AND CARPET CASTERS	\$35	TWIN WHEEL CASTER WHEEL: 60 MM BARREL: 25 MM LOAD RATING: 140 LBS*	Designed for use on hardwood floors, tile, chair mats, linoleum and concrete surfaces in an open office/workspace environment. (Lab, healthcare, classroom, and conference room.) Wheels are made from a soft polyurethane material. Set of five used with star bases.

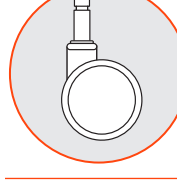
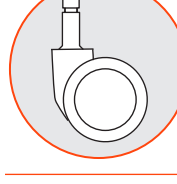
	C7 CHROME-ACCENTED HARD FLOOR AND CARPET CASTERS	\$35	TWIN WHEEL CASTER WHEEL: 60 MM BARREL: 25 MM LOAD RATING: 140 LBS*	Recommended for use on carpeted and hard floor surfaces. Large diameter hard nylon wheels are recommended for use on low to medium pile carpeting with or without padding and hard floors. 65mm dual wheels place more wheel surface on the carpet pile for optimum weight distribution and ease of movement. Wheels move in opposite directions to minimize carpet fiber twisting.
	C8S LARGE DIAMETER HARD FLOOR AND CARPET CASTERS	\$35	TWIN WHEEL CASTER WHEEL: 75 MM BARREL: 22 MM LOAD RATING: 160 LBS*	Recommended for use on carpeted or hard surfaces. Large diameter soft nylon wheels are recommended for use on low to medium pile carpeting with or without padding. 75mm dual wheels place more wheel surface on floors for optimum weight distribution and ease of movement. Wheels move in opposite directions to minimize carpet fiber twisting.
	C9S COMPRESSION-LOCKING HARD FLOOR AND CARPET CASTERS	\$50	HOODED TWIN WHEEL CASTER WHEEL: 50 MM BARREL: 42 MM LOAD RATING: 110 LBS*	Designed for use on hardwood floors, tile, chair mats, linoleum and concrete surfaces in an open office/workspace environment. (Lab, healthcare, classroom, and conference room.) The wheels feature compression-lock; The brakes engage when the user is seated in the chair. When seated this prevents the user from rolling away from the work surface.
	C10BS DECOMPRESSION HARD FLOOR AND CARPET CASTERS	\$35	TWIN WHEEL CASTER WHEEL: 65 MM BARREL: 23 MM LOAD RATING: 110 LBS*	Designed for use on carpet, hardwood floors, tile, chair mats, linoleum and concrete surfaces in an open office/workspace environment. (Lab, healthcare, classroom, and conference room.) The wheels feature auto-lock; The safety brakes engage when the chair is not in use, this prevents the chair from rolling away when standing up.
	C10GS DECOMPRESSION HARD FLOOR AND CARPET CASTERS	\$35	TWIN WHEEL CASTER WHEEL: 60MM BARREL: 25 MM LOAD RATING 110 LBS*	Recommended on hard and carpet floor surfaces. The wheels feature a reverse compression lock to engage when the user is not seated in the chair. As the user lifts out of the chair, the caster prevents the chair from rolling away. Set of five used with star bases.
	C11S COMPRESSION-LOCKING HARD FLOOR AND CARPET CASTERS	\$50	TWIN WHEEL CASTER WHEEL: 50 MM BARREL: 18 MM LOAD RATING: 110 LBS*	Designed for use on hardwood floors, tile, chair mats, linoleum and concrete surfaces in an open office/workspace environment. (Lab, healthcare, classroom, and conference room.) The wheels feature compression-lock; The brakes engage when the user is seated in the chair. When seated this prevents the user from rolling away from the work surface.
	C12S HARD FLOOR AND CARPET CASTERS	\$25	TWIN WHEEL CASTER WHEEL: 50 MM BARREL: 16 MM LOAD RATING: 110 LBS*	Designed for use on hardwood floors, tile, chair mats, linoleum and concrete surfaces in an open office/workspace environment (Lab, healthcare, classroom and conference room). Can be used on carpet surfaces. Wheels are made of soft polyurethane material. Set of four used on guest or classroom chairs.
	C22B/G HUBLESS HARD FLOOR AND CARPET CASTERS	\$35	TWIN WHEEL CASTER WHEEL: 60 MM BARREL: 25MM LOAD RATING: 110 LBS*	Recommend for use on Carpet or Hard floors. Wheels made of Polyurethane. Available in Black or Gray accents. Stylish hubless design.

control selection guide

BASIC TASK

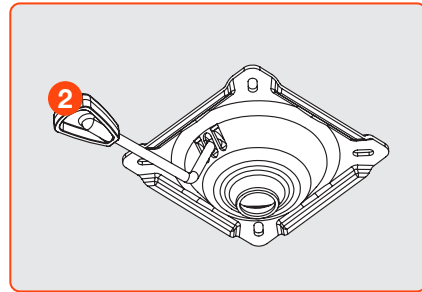

B1 BASIC TASK

- 360° swivel
 - Pneumatic cylinder height adjustment
- Exclusively on Diddy, Dash Task and Vox Task.*

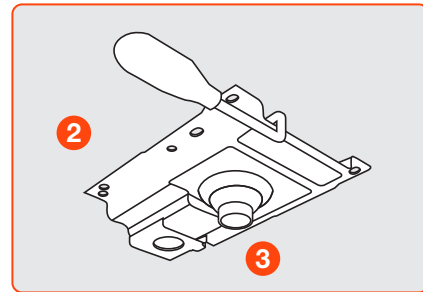

B2 BASIC TASK WITH BACK DEPTH ADJUSTMENT

- Adjustable back depth
- 360° swivel
- Pneumatic cylinder height adjustment

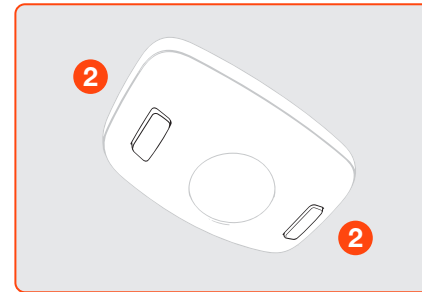

B3 BASIC TASK

- 360° swivel
 - Push-button pneumatic cylinder height adjustment
- Exclusively on Remy.*

POSTURE BACK

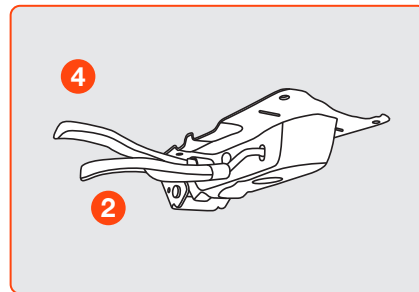

P1 POSTURE BACK

- Infinite back angle adjustment with free float
- 360° swivel
- Pneumatic cylinder height adjustment

SWIVEL TILT

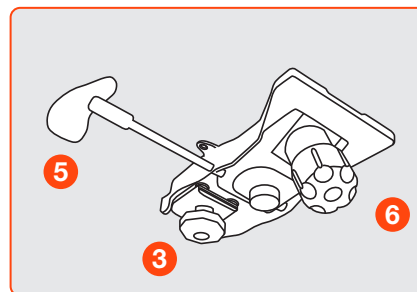

S2 SWIVEL TILT WITH BACK DEPTH ADJUSTMENT

- Adjustable back depth
- Upright lock
- Center knob tension adjustment
- 360° swivel
- Pneumatic cylinder height adjustment

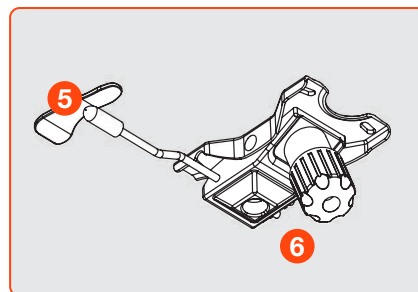

S3 SWIVEL TILT

- Upright lock
- Center knob tension adjustment
- 360° swivel
- Pneumatic cylinder height adjustment

1	INFINITE BACK ANGLE ADJUSTMENT	7	INFINITE POSITION TILT-LOCK
2	SEAT HEIGHT LEVER	8	FORWARD TILT LEVER
3	BACK DEPTH CONTROL KNOB	9	EASY-LIFT RATCHET BACK HEIGHT CONTROL
4	ARTICULATING POSTURE BACK W/ FREE FLOAT	10	BACK MULTI-LOCK W/ SAFETY RELEASE
5	SEAT HEIGHT & TILT LOCK LEVER	11	SEAT SLIDER PADDLE
6	TILT TENSION CONTROL KNOB	12	4 POSITION BACK TRAVEL CONTROL

CONTROL FUNCTION GUIDE

ROCKING TILT

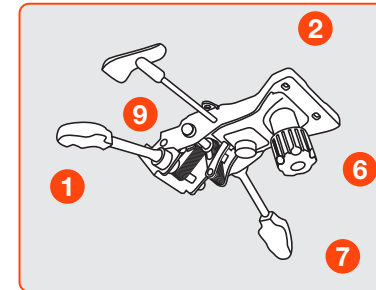

R1 ROCKING TILT

- Infinite back angle adjustment
- Infinite tilt lock
- Center knob tension adjustment
- 360° swivel
- Pneumatic cylinder height adjustment

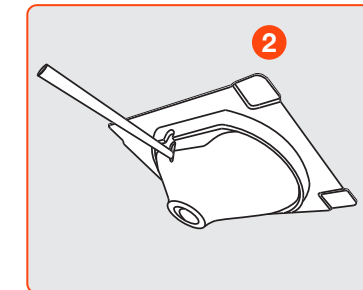

R2 ROCKING TILT FOR LOUNGE AND GUEST

- Rock left, right, front and back
 - 360° swivel
 - Pneumatic cylinder height adjustment
- Exclusively on Jax Side, Lilly Side, Diddy Guest, Dash Task and Vox Task.*

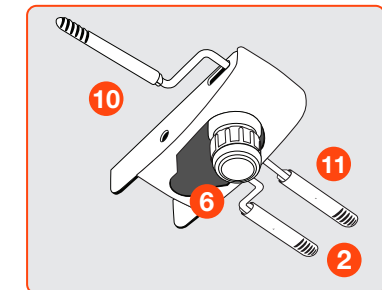

R3 ROCKING TILT

- Integrated seat slider
 - Upright lock
 - Center knob tension adjustment
 - 360° swivel
 - Pneumatic cylinder height adjustment
- Exclusively on HÅG Capisco and Capisco Puls.*

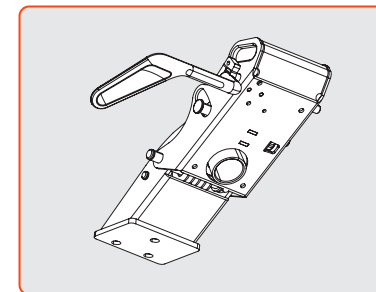

R4

- 360 swivel
- Upright tilt lock
- Pneumatic cylinder height adjustment
- Exclusively on Ellie

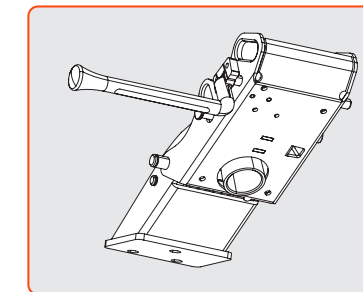

R5

- 360 swivel
- Pneumatic cylinder height adjustment
- Exclusively on Ellie

KNEE TILT

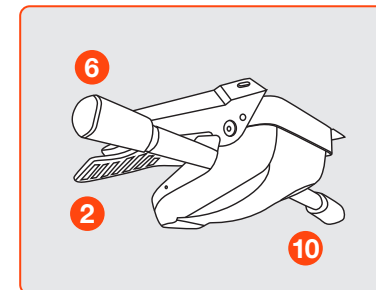

K2 ADVANCED KNEE TILT

- 4-position tilt lock
 - Side knob tension adjustment
 - 360° swivel
 - Pneumatic cylinder height adjustment
- Exclusively on Core and Vault.*

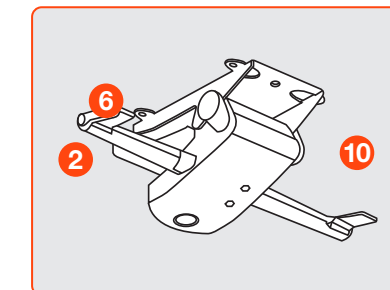

K3 ADVANCED KNEE TILT

- 4-position tilt lock
 - Side knob tension adjustment
 - 360° swivel
 - Pneumatic cylinder height adjustment
- Exclusively on Cydia.*

control selection guide

SYNCHRO TILT

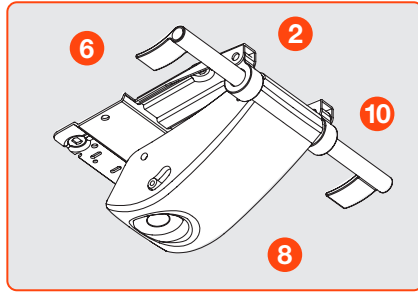

X2 DYNAMIC SYNCHRO TILT

- Integrated seat slider
- 11-position tilt lock
- 10° forward tilt
- Side knob tension adjustment
- 2.6:1 back-to-seat tilt ratio
- 360° swivel
- Pneumatic cylinder height adjustment

Exclusively on Cosmo.

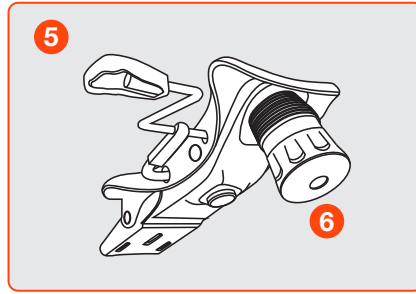

Y1 SIMPLE SYNCHRO TILT

- Upright tilt lock
- 3:1 back-to-seat tilt ratio
- Center knob tension adjustment
- 360° swivel
- Pneumatic cylinder height adjustment

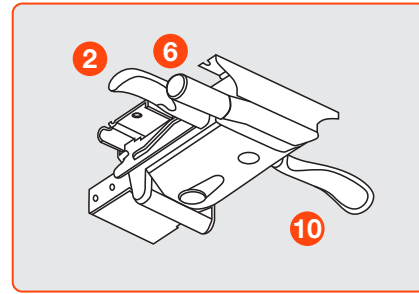

Y2 HEAVY DUTY SYNCHRO TILT

- 4-position tilt lock
- Side knob tension adjustment
- 2:1 back-to-seat tilt ratio
- 360° swivel
- Pneumatic cylinder height adjustment

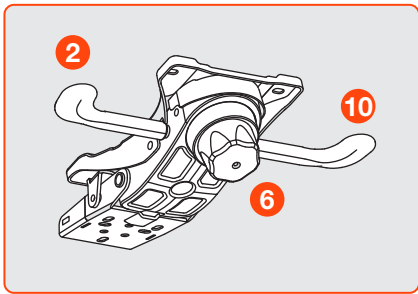

Y3 FULL SYNCHRO TILT

- 3-position tilt lock
- 2:1 back-to-seat tilt ratio
- Center knob tension adjustment
- 360° swivel
- Pneumatic cylinder height adjustment

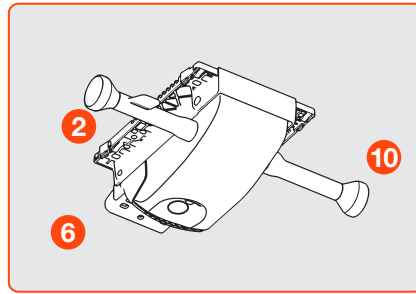

Y6 DELUXE SYNCHRO TILT

- 4-position tilt lock
- Side knob tension adjustment with 7 settings
- 2:1 back-to-seat tilt ratio
- 360° swivel
- Pneumatic cylinder height adjustment

Exclusively on Sol and Tori.

WEIGHT-BALANCED

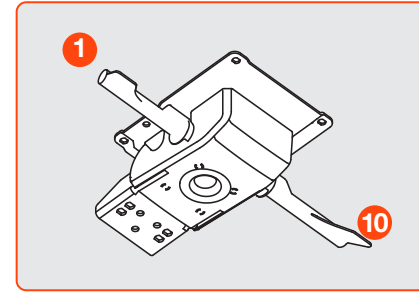

W1 WEIGHT-BALANCED SYNCHRO TILT

- Automatic tension adjustment
- 2-position tilt lock
- 3:1 back-to-seat tilt ratio
- 360° swivel
- Pneumatic cylinder height adjustment

Exclusively on Core, Luna and Neo.

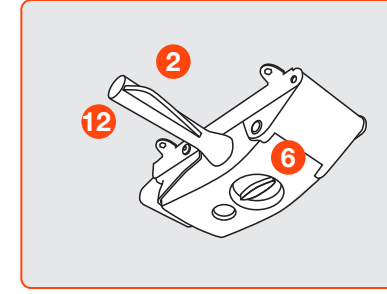

W2 ADVANCED WEIGHT-BALANCED SYNCHRO TILT

- Automatic tension adjustment with option to modify
- Tilt-limiter 4-position lock
- 3:1 back-to-seat tilt ratio
- 360° swivel
- Pneumatic cylinder height adjustment

Exclusively on Acclaim and Luna.

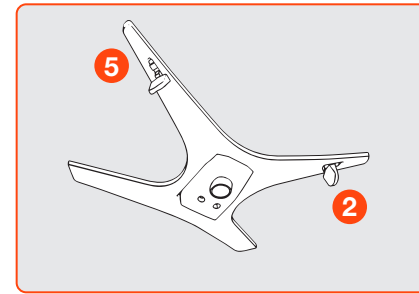

Z1 SIMPLE WEIGHT-BALANCED

- Automatic tension adjustment
- 12° recline or upright tilt lock
- 360° swivel
- Pneumatic cylinder height adjustment

Exclusively on Mila.

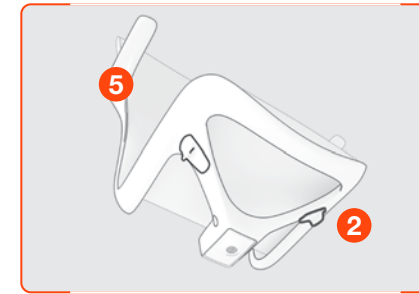

Z2 SIMPLE WEIGHT-BALANCED

- Automatic tension adjustment
- 9° recline or upright tilt lock
- 360° swivel
- Pneumatic cylinder height adjustment

Exclusively on Omnia.

MULTI-FUNCTION

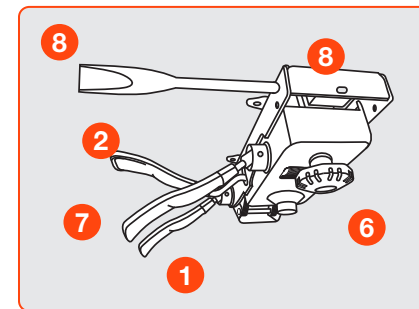

M1 MULTI-FUNCTION

- Infinite back angle adjustment
- 6° forward tilt
- Center knob tension adjustment
- 360° swivel
- Pneumatic cylinder height adjustment

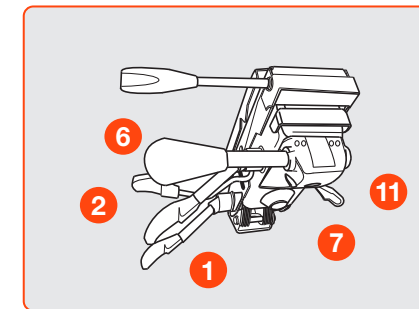

M2 HEAVY DUTY MULTI-FUNCTION

- Weight capacity up to 500 lbs.
- Integrated seat slider
- Infinite back angle adjustment
- 6° forward tilt
- Side knob tension adjustment
- 360° swivel
- Pneumatic cylinder height adjustment

Exclusively on Logic Plus.

controls by series

	B1 B2 B3	P1	S2 S3	R1/R2/R3/R4/R5	K2 K3	Y1	Y2	Y3
	Basic	Posture Tilt	Swivel Tilt	Rocking Tilt	Knee Tilt	Simple Synchro	Heavy Duty Synchro Tilt	Full Synchro
Acclaim							✓	✓
Agent	✓	✓	✓	✓			✓	
Agent Stools	✓	✓						
Bella Task	✓		✓					
Bella Stools	✓							
Bristol			✓	✓			✓	
Bristol Stools		✓						
Core					✓			
Core Stools								
Cortina			✓				✓	
Cosmo								
Cydia			✓		✓			
Cydia Stools			✓					
Dash	✓		✓	✓				
Diddy	✓		✓	✓				
Ellie				✓				
HÅG Capisco				✓				
HÅG Capisco Puls				✓				
Jax Side				✓				
Lilly Side	Low-back	Low-back		✓				
Logic	Low-back	Low-, Mid-back	✓	✓			✓	
Logic Stools								
Logic Plus								
Luna						✓		✓
Luna Stools						✓		
Mila								
Neo Lite						✓		✓
Neo Lite Stools						✓		
Neo						✓		✓
Neo Stools						✓		
Omnia								
Omnia Stools								
Remy	✓							
Sol								
Strata							✓	
Strata Stools							✓	
Strata Lite						✓		
Strata Lite Stools						✓		
Theory						✓	✓	✓
Theory Stools						✓		
Tori						✓		
Vault					✓	✓		✓
Vault Stools						✓		
Vox	✓		✓	✓				
Zoom Task	✓		✓	✓				
Zoom Stools	✓							

controls by series

	Y4	Y6	X2	W1	W2	Z1 Z2	M1 M2
	Intensive Synchro	Deluxe Synchro	Dynamic Synchro	Weight Balanced Synchro	Advanced Weight Balanced Synchro	Simple Weight Balanced	Multi-function
Acclaim					✓		
Agent							✓
Agent Stools							
Bella Task							
Bella Stools							
Bristol							✓
Bristol Stools							
Core				✓			
Core Stools				✓			
Cortina							✓
Cosmo			✓				
Cydia							
Cydia Stools							
Dash							
Diddy							
HÅG Capisco							
HÅG Capisco Puls							
Jax Side							
Lilly Side							
Logic							✓
Logic Stools							
Logic Plus							✓
Luna				✓	✓		
Luna Stools							
Mila						✓	
Neo Lite							
Neo Lite Stools							
Neo				✓			
Neo Stools							
Omnia						✓	
Omnia Stools						✓	
Remy							
Sol		✓					
Strata							
Strata Stools							
Strata Lite	✓						
Strata Lite Stools							
Theory							
Tori		✓					
Theory Stools							
Vault							
Vault Stools							
Vox							
Zoom Task							
Zoom Stools							

Bases

Model number	Description	List Price
BA1B	26" Nylon - Black	\$75
BA1HD	26" Heavy Duty Nylon (Logic Plus) - Black	\$110
BA2B/S	26" Aluminum - Black, Silver	\$110
BA11B/G	27" Mid-Profile Nylon - Black, Graphite	\$75
BA12B/P/S	27" Mid-Profile Aluminum - Black, Polished, Silver	\$110
BA14P	26" Aluminum Four-Star - Polished	\$110
BA16B/P	27" Mid-Profile Aluminum - Polished	\$110
BA21B/S/W	26" Low-Profile Aluminum (HÅG Capisco & HÅG Capisco Puls) - Black, Silver, White	\$155
BA26B/D/W	27" Low Profile Nylon Base - Black, Dove Gray, White	\$75
BA27B/S/W	24.5" Low-Profile Aluminum (HÅG Tion) - Black, Silver, White	\$155
BA36P/S	27" Mid-Profile Aluminum (Sol 7 Tori) - Polished, Silver	\$110
Lilly Counter Frame	ST24 Frame Only - Black, Silver	\$190
Lilly Bar Frame	ST30 Frame Only - Black, Silver	\$210
FR18	18" Foot Ring (HÅG Capisco & HÅG Capisco Puls)	\$165
FR20	20" Foot Ring	\$90
JB1	Jury Base - Standard	\$300
JB2	Jury Base - Quick Release	\$675
JB2-PLT	Ramp Insert for JB2	\$100
G25B	Koble Adjustable Glides	\$35

Cylinders

CY16	3" Lift	\$30
CY17	3" Lift	\$30
CY18	4" Lift	\$30
CY19	5" Lift	\$30
CY19H	5" Lift	\$30
CY20	5" Lift	\$30
CY20N	No Lift	\$30
CY24	5" Lift	\$30
CY30	8" Lift	\$30
CY36	10" Lift	\$30
CY9N	No Lift, Free Swivel (Lilly 9131/9134, Jax 9236/9231/9234)	\$30
CY9NA	No Lift, Auto-Return (Lilly 9131/9134, Jax 9236/9231/9234)	\$50
CY23	5.1" Lift (HÅG Capisco and HÅG Capisco Puls)	\$85
CY29	6.9" Lift (HÅG Capisco and HÅG Capisco Puls)	\$85
CY37	9.5" Lift (HÅG Capisco and HÅG Capisco Puls)	\$85
CYL-AHRB	5" Lift (For use with jury base option)	\$150

Headrests

XX0	Vault Headrest - M2 or M4	\$85
XX0	Theory Headrest - Upholstered	\$85
XX0	Strata Headrest - Upholstered	\$120
HRFB/S	HÅG Capisco Headrest - Fabric	\$310
HRLB/S	HÅG Capisco Headrest - Leather	\$325

Accessories

DL5	Stacking Cart	\$399
DL7	Stacking Cart	\$399
BRK	Book Rack (Shuttle)	\$70
GC1	Ganging Clip	\$30
GC2	Ganging Clip	\$30

Accessories cont.

GC5	Ganging Clip	\$20
GC7	Ganging Clip	\$30
GC8	Ganging Clip	\$30
GC9	Ganging Clip	\$30
PS	on Logic	\$50
BT	Bolt (B2, S2)	\$15
BN1/BN2	Upholstered Back w/Ballistic Nylon (Logic, Shuttle)	\$35
AW1	4" Arm Width Adjustment Bracket (A4, A6, A8, A36)	\$25

Arm Pads

Please note that each arm pad is sold individually, not as a set of two. Some parts require a left or right specification.

ARM-P8000-101/102	Compatible with Sophie. Specify Black or Gray.	\$50
ARM-PAD22-101	Compatible with Core A22.	\$30
ARM-PAD33-L/R01	Compatible with Cosmo A33. Specify L or R.	\$30
ARM-PAD38-R/L01-V2	Compatible with Cosmo A38. Specify L or R.	\$30
ARM-PAD40-101	Compatible with A40.	\$30
ARM-PAD41-AS1	Compatible with A41.	\$30
ARM-PAD47L/R-P33	Compatible with Mila. Specify L or R.	\$30
ARM-PADA4-101	Compatible with A4, A5, A90.	\$20
ARM-PADA6-101	Compatible with A6, A7.	\$30
ARM-PADA8-101	Compatible with A8, A9.	\$25
ARM-PAD57-P01	Compatible with A57, A58, A59 in Black.	\$30
ARM-PAD57-P14	Compatible with A57, A58, A59 in Dove Gray.	\$30

Controls

MEC-B0010-101	B1 Basic Task	\$50
MEC-B0020-101	B2 Basic Task with Depth Adjustment	\$50
MEC-P0010-101	P1 Posture Back	\$80
MEC-S0020-101	S2 Swivel Tilt with Back Depth Adjustment	\$60
MEC-S0030-101	S3 Swivel Tilt	\$60
MEC-R0010-101	R1 Rocking Tilt	\$70
MEC-R0020-000	R2 Rocking Tilt for Lounge and Guest	\$80
MEC-R0030-101	R3 Rocking Tilt	\$250
MEC-K0020-101-V5	K2 Advanced Knee Tilt	\$140
MEC-K0030-101	K3 Advanced Knee Tilt	\$140
MEC-Y0010-101	Y1 Simple Synchro Tilt	\$70
MEC-Y0020-101	Y2 Heavy Duty Synchro Tilt	\$130
MEC-Y0030-101	Y3 Full Synchro Tilt	\$90
MEC-Y0040-101	Y4 Intensive Synchro	\$160
MEC-Y0050-101-V2	Y5 Deluxe Synchro Tilt	\$170
MEC-Y0060-101	Y6 Deluxe Synchro Tilt	\$180
MEC-X0020-101	X2 Dynamic Synchro Tilt	\$160
MEC-W0010-101	W1 Weight-Balanced Synchro Tilt	\$120
MEC-W0020-101	W2 Advanced Weight-Balanced Synchro Tilt	\$140
MEC-M0010-101	M1 Multi-Function	\$140
MEC-M02HD-101	M2 Heavy Duty Multi-Function	\$240

product options

HEAVY DUTY SEATING

	BRISTOL	CAVO BARIATRIC	CAVO GUEST	LOGIC	LOGIC PLUS	LUNA	SHUTTLE BARIATRIC	SOPHIE BARIATRIC	STRATA	THEORY	TORI
Models	2360-Y2 2380-Y2	1912	1910	1760-Y2 1760-M1 1780-Y2 1780-M1	1790-M2	3460-Y3	1250-GT	8119-GT	1560-Y2 1580-Y2	2160-Y2 2180-Y2	3560-Y6
Weight Capacity	350 LBS.	750 LBS.	350 LBS.	350 LBS.	500 LBS.	350 LBS.	600 LBS.	500 LBS.	350 LBS.	350 LBS.	350 LBS.
Warranty	10 YEARS MULTI-SHIFT	LIFETIME SINGLE-SHIFT	LIFETIME SINGLE-SHIFT	10 YEARS MULTI-SHIFT	10 YEARS SINGLE-SHIFT	10 YEARS MULTI-SHIFT	LIFETIME SINGLE-SHIFT	12 YEARS MULTI-SHIFT	10 YEARS MULTI-SHIFT	10 YEARS MULTI-SHIFT	10 YEARS MULTI-SHIFT

TASK SEATING OPTIONS

	Agent	Bristol	Core	Cydia	HÅG Capisco	HÅG Capisco Puls	Logic	Luna	Mila	Neo	Neo Lite	Sol	Strata	Strata Lite	Theory	Tori	Vault
Back Size																	
One Size			✓		✓	✓		✓	✓	✓	✓	✓					
Low-Back	✓						✓										
Mid-Back	✓	✓		✓			✓						✓	✓	✓	✓	✓
High-Back		✓		✓			✓						✓	✓	✓	✓	✓
Back Material																	
Knit Back									✓								
Mesh Back				✓				✓	✓	✓	✓	✓	✓	✓	✓	✓	✓
Upholstered Back	✓	✓	✓	✓	✓		✓		✓			✓				✓	
Plastic Back						✓											
Seat Material																	
Mesh Seat				✓									✓	✓	✓		
Upholstered Seat	✓	✓	✓	✓	✓	✓	✓	✓	✓	✓	✓	✓	✓	✓	✓	✓	✓
Models																	
Task Chair	✓	✓	✓	✓	✓	✓	✓	✓	✓	✓	✓	✓	✓	✓	✓	✓	✓
Task Stool	✓	✓	✓	✓	✓	✓	✓	✓	✓	✓	✓	✓	✓	✓	✓	✓	✓
Guest Chair				✓				✓					✓				
Lumbar																	
Height & Depth Adjustable													Standard	Standard			
Height Adjustable				Optional				Optional		Standard	Standard	Standard			Standard	Optional	
Ratchet Back	P1, R1, M1, Y2 Standard	Standard	Standard		Standard	Standard	P1, R1, M1, Y2 Standard								Standard		Standard
Frame Colors																	
Black			PBK	PBK	BF	BF		PBK	BF	PBK	PBK		BF	BF	BF	PBK	BF
Dove Gray								PDG								PDG	
Graphite Gray				PGG						PGG	PGG						
Silver					SF	SF						SF	SF				
White				PWH	WF	WF				PWH	PWH					PWH	
Polished Aluminum								PF									PF

MESH SELECTION

	M01	M1	M2	M3	M4	M6	KIP MESH	OMNIA MESH
Bella		✓						
Clary		✓	✓	✓	✓			
Cosmo		✓	✓	✓	✓			
Cydia		✓		✓				
Kip							✓	
Link		✓						
Luna			✓		✓			
Luna Side			✓		✓			
Mila			✓		✓			
Neo				✓	✓			
Neo Lite				✓				
Omnia								✓
Shuttle		✓	✓	✓	✓			
Sol			✓		✓			
Strata	✓							
Strata Lite	✓							
Theory		✓		✓				
Tori								✓
Vault			✓		✓			
Zoom				M32 & M33				

Glide Code/Name/Price	Load Rating	Surfaces	Chairs
 G1 \$30 STATIONARY BASE GLIDE	110 LBS.	ALL SURFACES EXCEPT HARD FLOORS	
 G8 \$20 SWIVEL STEEL GLIDE	150 LBS.	CARPET	JAX, LILLY, SHUTTLE
 G9 \$20 SWIVEL NYLON GLIDE	150 LBS.	ALL SURFACES	JAX, LILLY, SHUTTLE
 G10 \$20 SWIVEL FELT GLIDE	110 LBS.	ALL SURFACES EXCEPT CARPET, CONCRETE, AND TILE	JAX, LILLY, SHUTTLE
 G16 \$15 SLED BASE CLEAR PLASTIC GLIDE	90 LBS.	ALL SURFACES EXCEPT CARPET, VCT, AND WOOD	KELLEY, JAX WIRE, LILLY STOOL, LILLY WIRE
 G17 \$25 SLED BASE CLEAR PLASTIC GLIDE	90 LBS.	ALL SURFACES EXCEPT CARPET, CONCRETE, AND TILE	KELLEY, JAX WIRE, LILLY STOOL, LILLY WIRE
 G18 \$15 DOME GLIDE	125 LBS.	CARPET, HARD FLOORS	JAX, LILLY, SHUTTLE
 G19 \$15 TAPERED PLASTIC GLIDE	125 LBS.	CARPET, HARD FLOORS	CLARY, LUNA, SHUTTLE
 G19S \$20 SWIVEL STEEL GLIDE	125 LBS.	CARPET	CLARY, LUNA, SHUTTLE
 G19N \$20 SWIVEL NYLON GLIDE	125 LBS.	ALL SURFACES	CLARY, LUNA, SHUTTLE
 G19F \$20 SWIVEL FELT GLIDE	125 LBS.	ALL SURFACES EXCEPT CARPET, CONCRETE, AND TILE	CLARY, LUNA, SHUTTLE
 G21 \$20 TAPERED PLASTIC GLIDE	125 LBS.	CARPET, HARD FLOORS	DASH, VOX
 G21S \$20 SWIVEL STEEL GLIDE	125 LBS.	CARPET	DASH, VOX
 G21N \$20 SWIVEL NYLON GLIDE	125 LBS.	ALL SURFACES	DASH, VOX
 G21F \$20 SWIVEL FELT GLIDE	125 LBS.	ALL SURFACES EXCEPT CARPET, CONCRETE, AND TILE	DASH, VOX
 G22F STATIONARY FELT GLIDE	125 LBS.	ALL SURFACES EXCEPT CARPET, CONCRETE, AND TILE	ELLIE
 G22T STATIONARY TEFLON GLIDE	125 LBS.	ALL SURFACES	ELLIE
 G23FT STATIONARY GLIDE - FELT/TEFLON	125 LBS.	ALL SURFACES	ELLIE

*Load Rating in (lbs) per caster/glide

BIFMA Ultimate Test for Fit (UTFF)

Ergonomics - The Work Chair

The Business and Institutional Furniture Manufacturer's Association (BIFMA) has developed the following guidelines for UTFF. Parenthetical numbers following each item indicate corresponding subdivisions in the guidelines.

Seat Height (7.1)

Users should be able to sit with their feet comfortably on the floor or footrest without undue pressure on the underside of the thighs. The thigh-to-torso angle should not be less than 90°.

Seat Depth (7.2)

Users should be able to sit in the chair without undue pressure against the back of the knees, their back properly supported by the backrest and with adequate buttock and thigh support.

Seat Width (7.3)

The seat should be wider than the hip breadth of the user with allowance for movement and clothing. The seat width should not limit the ability to use the armrests comfortably.

Seat Pan Angle (7.4)

This should allow users to support their feet on the floor or footrest. They should not cause the user's torso-to-thigh angle to be less than 90°. Forward seat pan angles should not cause users to shift excessive weight to their feet or experience the sensation of sliding out of the chair.

Back Support (7.5)

Seat Backrest Height (7.5.1)

All backrests should provide adequate support and buttocks clearance. For tasks requiring upper body mobility, the backrest should not interfere with the user's movement. For users who prefer reclining postures or greater upper back support, the back height should provide support for the shoulder blades.

Backrest Width (7.5.2)

The width of the backrest should provide adequate support for the curvature of the user's back without causing localized pressure points.

Lumbar Support (7.5.3)

The height and shape of the lumbar should coincide with the lumbar curve ("the small") of the user's back. The support should be firm, but not cause localized pressure points.

Movements of the Seat Pan and Back Support (7.6)

The user should be able to sit in a position where the torso-to-thigh angle is equal to or greater than 90°. The seat and backrest angles should accommodate the varying postures assumed by the user throughout the day.

Arm Support (7.7)

Armrest Height (7.7.1)

This should allow users to sit in a variety of postures while supporting their forearms and/or elbows in a manner that avoids lifting the shoulders (armrests too high) or leaning to the side to reach the armrest (armrests too low). The armrest height should allow accessibility to, and performance of, tasks.

Armrest Length (7.7.2)

The length of the armrest should allow users to sit close enough to the work surface to perform their tasks while maintaining contact with the backrest.

Inside Distance Between Armrests (7.7.3)

Armrests should allow users to sit in a variety of postures while supporting their forearms in a manner that avoids lifting the shoulders and/or excessive outward positioning of the elbows. Armrests should allow accessibility to, and performance of, tasks. The inside distance between the armrests should allow the user to enter and exit the chair easily. The hips should comfortably fit between the armrests or supports.

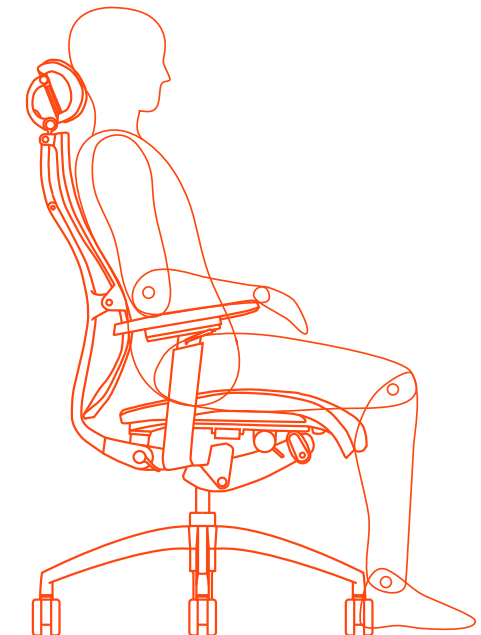

care and maintenance

- Ensure the gas cylinder is inserted into the control firmly. Improper connection may cause wobbling.
- Choose correct casters for different floor surfaces. We suggest choosing hard floor casters for tile or concrete surfaces.
- For drafting stool use, we recommend self-locking casters for hard floors. See Caster Guide for more details.
- Do not stand on foot ring.
- Do not sit on any part of the chair except the seat. Do not sit on arms or backrest.
- To avoid chair collapse, do not remove knobs or screws.
- Properly dispose of packing materials. Do not use plastic as head covering. It may cause suffocation.
- If any parts are missing, broken, damaged or worn, do not use the chair until repairs are made using factory-authorized parts.
- Do not attempt to make any alterations to chair.
- Do not use chair on uneven floor surfaces.
- Do not drape coats or sweaters on back of chairs with casters. Hanging fabric may suddenly stop casters from rolling.
- Do not use excessive speed when moving the chair with casters while seated.
- Do not overexert the functions of a chair which are only to be used under normal conditions.
- Do not stand on and/or use this chair as a stepladder. Use this product only for seating one person at a time.
- Do not use this chair unless all bolts, screws and knobs are firmly secured.

Check the following at 4 month intervals;

- All exposed fasteners should be checked and any loose fasteners tightened. Use appropriate tools. Replace any fasteners that appear to be damaged in any way.
- The chair mechanism should be checked for any looseness, excessive wear or signs of damage. Immediately remove the chair from service if any damage or failure is found.
- The base and casters should be checked for any signs of excessive wear for failure. Immediately replace any parts that show such wear or failure.

notes

notes

