

Neo Lite

INS-P3150-Y1-PAC

ASSEMBLY
INSTRUCTIONS

9to5[®]
seating



PARTS

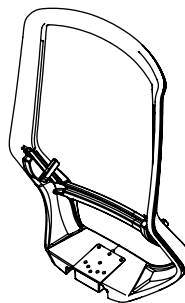

Back (x1)

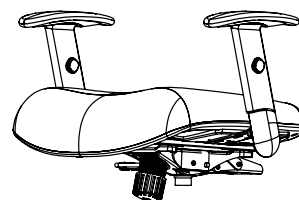

Seat (x1)



Base (x1)

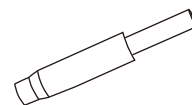

Cylinder (x1)



Casters (x5)

TOOLS



Allen Wrench (x1)
(attached to the
bag with casters)

HARDWARE



Bolts (x3)
(attached to the
seat back)

All hardware comes pre-attached in the back and/or seat.
Missing parts or hardware? Call 888.925.SEAT

STEP 1

Attach the casters and cylinder to the 5-star base.

1A. Firmly press the stems
of 5 casters into the 5 holes
in the base.

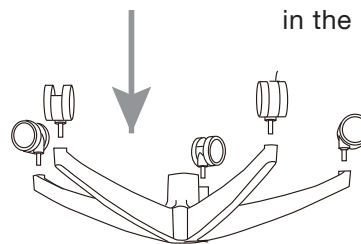

1B. Insert cylinder into
the center hole.

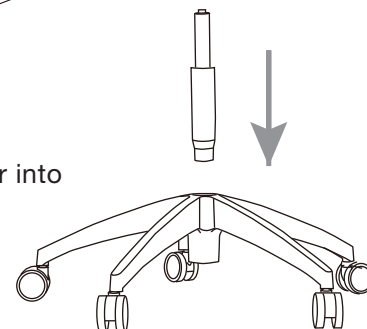

STEP 2

Attach the back to the seat.

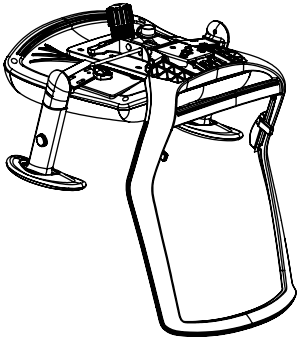

2A. Using the Allen wrench, remove the 3 bolts from the back.

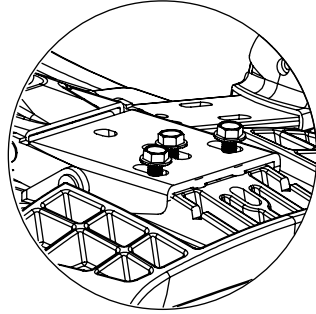

2B. Place the back plate under the seat as shown, aligning the holes. Using the Allen wrench, reattach the screws from the top. If you have difficulty inserting the back, you may try loosening the 4 bolts for the mechanism. Attach the back, then retighten the back bolts followed by the mechanism bolts.

STEP 3

Join the back and seat with the cylinder and base.

Insert the assembled back/seat unit onto the cylinder, which was placed in the base in Step 1. Press down firmly to secure.

